

HOLMIOS®

CATÁLOGO DE SOPORTES

Mounts catalogue





DESCÁRGATE
AQUÍ LA VERSIÓN
DEL CATÁLOGO EN PDF

Copyright © Garsaco Import S.L. 2023. Todos los derechos reservados. Queda terminantemente prohibido copiar, reproducir, difundir, publicar o modificar cualquier material incluido en el Sitio Web de Garsaco Import o en cualquier soporte derivado del mismo sin previo consentimiento expreso y escrito de Garsaco Import S.L.

HOLMIOS[®]
EASY SOLUTIONS!



FABRICANTES DE SOPORTES

Mount manufacturers

Holmios es la marca española de confianza especializada en todo tipo de soportes.

Con sede en la Comunidad Valenciana, somos fabricantes de todo tipo de soportes. Soportes para TV fijos y articulados, de brazo simple y doble, de techo y de pared, soportes para monitores de trabajo, elevadores de monitores de oficina, soportes de pequeño electrodoméstico, etc.

Nuestro objetivo es facilitar la vida de nuestros clientes

proporcionándoles productos innovadores con la mejor calidad precio. Conocemos las necesidades del mercado y apostamos por la innovación, el diseño y la calidad unidas a prácticas sostenibles y respetuosas con el medio ambiente.

Disfruta con seguridad de toda la gama con hasta 10 años de garantía.

Ofrecemos un trato personalizado, asesoramos a nuestros clientes en todo aquello que necesiten y brindamos un servicio post-venta integral.

Holmios is the trusted Spanish brand specialized in all types of mounts.

Based in the Valencian Community, we are manufacturers of all types of mounts. Fixed and articulated TV mounts, single and double arm, ceiling and wall mounts, supports for work monitors, elevators for office monitors, small appliance supports, etc.

Our goal is to make life easier for our clients

By providing innovative products with the best quality price. We know the needs of the market and we are committed to innovation, design and quality together with sustainable and respectful practices with the environment.

Enjoy safely the entire range with up to 10 years warranty.

We offer personalized treatment, we advise our clients on everything they need and we provide a comprehensive after-sales service.

CENTRO DE DISTRIBUCIÓN PARA EUROPA

Distribution logistics centre for Europe

Distribuimos por toda España y también en el mercado europeo (Francia, Portugal, Italia, Alemania...). Ofrecemos los mejores productos del mercado para poder satisfacer a todos nuestros clientes reales y potenciales. ¿Todavía no has descubierto nuestros productos? No esperes más y elije el que mejor se adapte a tus necesidades. :)

We sell and distribute throughout Spain and also in the European market (France, Portugal, Italy, Germany ...). We offer the best products on the market to satisfy all our real and potential clients. Still haven't discovered our products? Do not wait any longer and choose the one that best suits your needs. :)

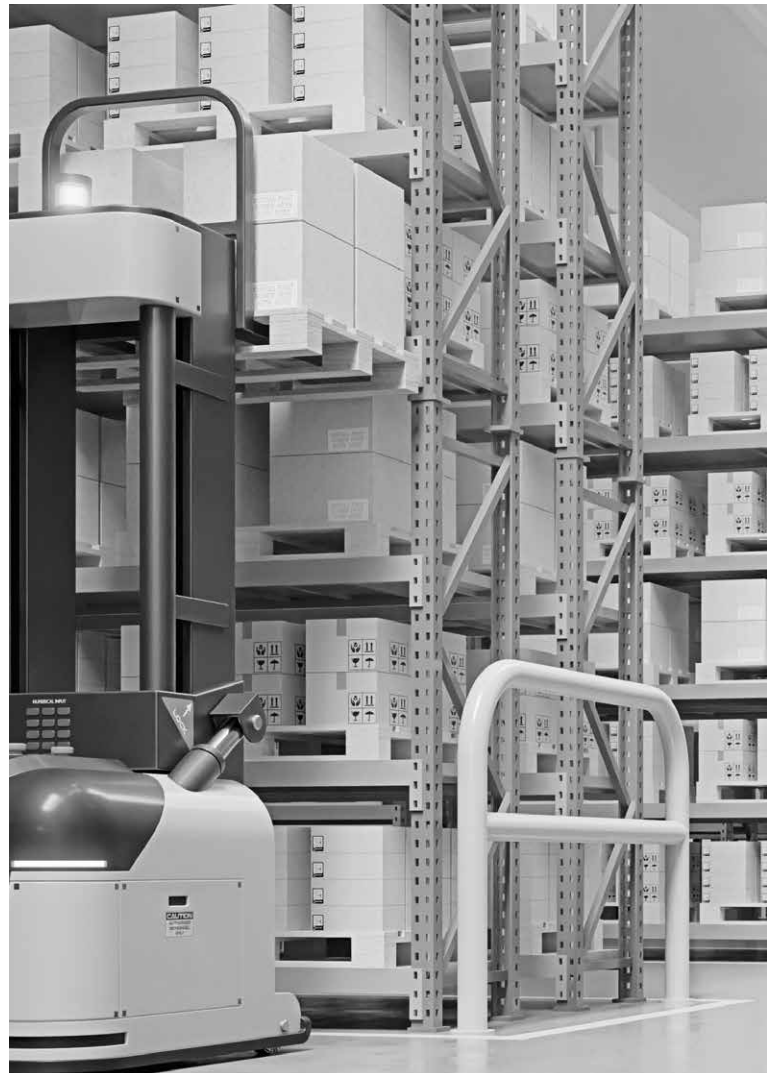

Líderes en diseño, desarrollo y fabricación

Leaders in design, development and manufacturing



Ánisis constante del mercado

Constant market analysis



Atención orientada al cliente

Customer-oriented service



Más de 20 años de experiencia

More than 20 years of experience

NO ESPERES MÁS PARA DESCUBRIR TODOS NUESTROS PRODUCTOS ¡ADELANTE!

Do not wait any more to discover all our products. Go ahead!

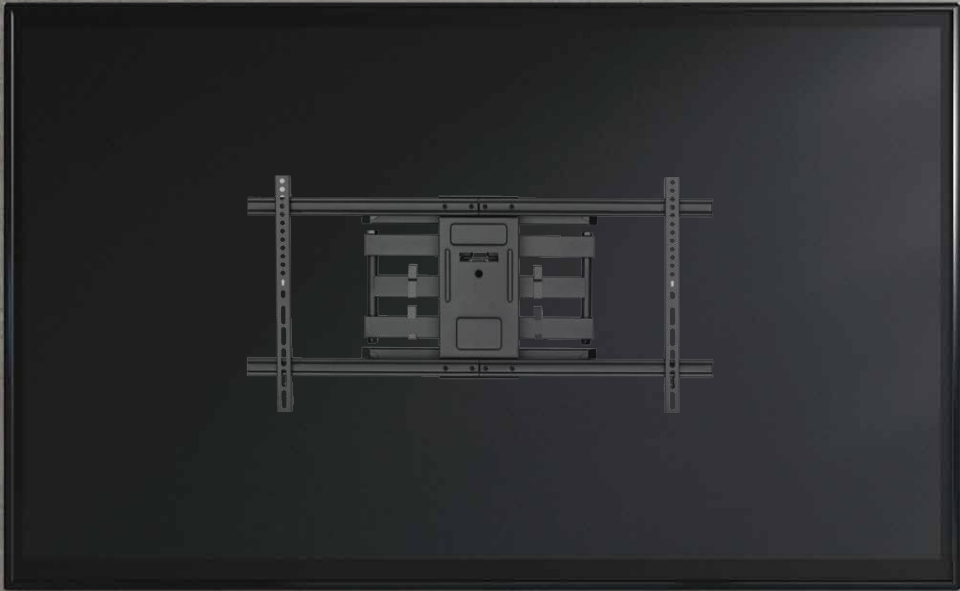

ÍNDICE

Index



Soportes TV para pared TV wall mount	13" - 27"	08
	13" - 42"	10
	23" - 42"	11
	32" - 55"	14
	37" - 70"	16
	37" - 80"	18
	37" - 90"	20
	43" - 80"	21
43" - 90"	22	
60" - 100"	23	
Soportes TV pared antirrobo Anti-theft wall brackets	43" - 90"	25
Soportes TV abatibles y/o motorizados Motorized TV mounts	32" - 75"	26
	32" - 80"	28
	32" - 70"	29
	37" - 80"	30
Soportes TV de pie TV floor stands	49" - 70"	31
	50" - 65"	32
	37" - 70"	33
	45" - 90"	34
Soportes techo Ceiling mounts		36
Soportes para PC PC mounts	Elevadores Desk mount	37
	Articulados Articulated	38
	Soporte monitor Monitor desk	39
	Soporte CPU CPU mount	39
Accesorios multimedia Multimedia supports	Accesorios TV TV Accesories	40
	Barra sonido Sound bar	41
	Soporte tablet / móvil Tablet / Mobile mount	42
Soportes varios Various brackets	Escuadra estante Shelf bracket	43
	Soporte aire acondicionado Air conditioning mount	43
	Soportes electrodomésticos Magnetic side rack	44
	Soporte dispensador gel Gel dispenser support	46
	Reposapiés Footrest	47
Información técnica Technical information		48

SOPORTES TV PARED

TV wall mount



A



B



A

B

Referencia / Reference	500055000	500055001
Descripción / Description	Soporte TV fijo Fixed TV wall mount	Soporte TV inclinable TV wall tilt mount
Pulgadas / Inch	13" - 27"	13" - 27"
Peso máximo Maximum weight	25Kg / 55lbs	30Kg / 66lbs
VESA	75x75 / 100x100	75x75 / 100x100
Inclinación arriba / abajo Tilt up / down	-	±20°
Oscilación lateral Oscillation	-	±30°
Ajuste nivel de pantalla Screen level adjustment	-	-
Material / Material	Acero / Steel	Acero / Steel
Apto para pantalla planas y curvas Flat and curved TV	-	-
Distancia / Distance	12.5mm	90mm
Color / Color	Negro / Black	Negro / Black
Brazo regulable Adjustable arm	-	-
Embalaje / Packaging	40	20

Dimensión
Product size

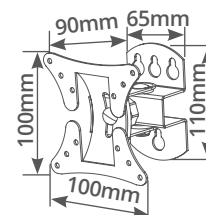
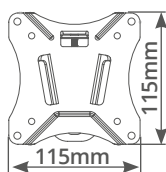

SOPORTE TV PARED CON BRAZO

TV wall mount swiveling arm



C



Diseño funcional. Máxima robustez y plegado perfecto.

Functional design. Maximum robustness and perfect folding.

C

Referencia / Reference	500055002
Descripción / Description	Sporte TV con brazo TV wall mount with swiveling arm
Pulgadas / Inch	13" - 27"
Peso máximo Maximum weight	15Kg / 33lbs
VESA	75x75 / 100x100
Inclinación arriba/abajo Tilt up / down	+3 / -10°
Oscilación lateral Oscillation	±90°
Ajuste nivel de pantalla Screen level adjustment	±3°
Material / Material	Acero + plástico / Steel + plastic
Apto para pantalla planas y curvas Flat and curved TV	-
Distancia / Distance	44-282mm
Color / Color	Negro / Black
Brazo regulable Adjustable arm	180°
Embalaje / Packaging	20

**Dimensión
Product size**

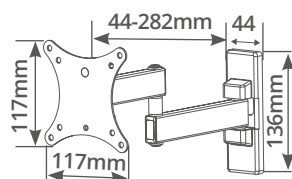

SOPORTE TV PARED CON BRAZO

TV wall mount swiveling arm



A

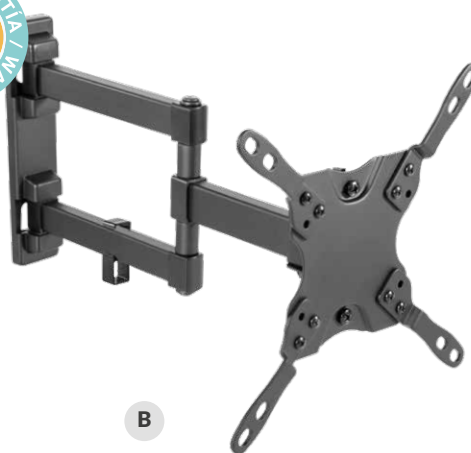

B

Colgar un televisor nunca había sido tan fácil. Gira, mueve y extiende.

Hanging a television has never been easier. Twist, move and extend.

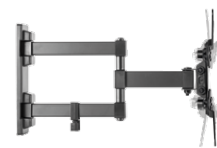
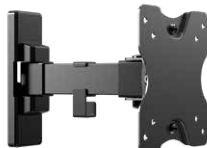

A

B

Referencia / Reference	500055016	500055017
Descripción / Description	Sporte TV con brazo TV wall mount swiveling arm	Sporte TV con brazo doble TV wall mount with swiveling double arm
Pulgadas / Inch	13" - 42"	13" - 42"
Peso máximo Maximum weight	20Kg / 44lbs	20Kg / 44lbs
VESA	75x75 / 100x100 200x100 / 200x200	75x75 / 100x100 200x100 / 200x200
Inclinación arriba/abajo Tilt up / down	+5° / -12°	+5° / -12°
Oscilación lateral Oscillation	±90°	±90°
Ajuste nivel de pantalla Screen level adjustment	±3°	±3°
Material / Material	Acero / Steel	Acero / Steel
Apto para pantalla planas y curvas Flat and curved TV	Sí / Yes	Sí / Yes
Distancia / Distance	60-190mm	60-364mm
Color / Color	Negro / Black	Negro / Black
Brazo regulable Adjustable arm	Sí / Yes	Sí / Yes
Embalaje / Packaging	10	8

Dimensión
Product size

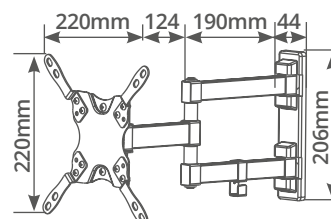
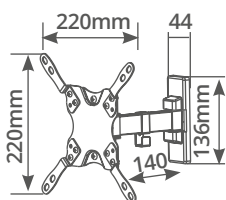

SOPORTES TV PARED

TV wall mount.



C



D



Extrafino.
Super slim.



C

D

Referencia / Reference	500055003	500055004
Descripción / Description	Soporte TV fijo Fixed TV wall mount	Soporte TV inclinable TV wall tilt mount
Pulgadas / Inch	23" - 42"	23" - 42"
Peso máximo Maximum weight	25Kg / 55lbs	30Kg / 66lbs
VESA	75x75 / 100x100 200x100 / 200x200	75x75 / 100x100 200x100 / 200x200
Inclinación arriba/abajo Tilt up / down	-	±20°
Oscilación lateral Oscillation	-	±30°
Ajuste nivel de pantalla Screen level adjustment	-	±3°
Material / Material	Aluminio / Aluminium	Acero / Steel
Apto para pantalla planas y curvas Flat and curved TV	Sí / Yes	Sí / Yes
Distancia / Distance	13mm	90mm
Color / Color	Negro / Black	Negro / Black
Brazo regulable Adjustable arm	-	-
Embalaje / Packaging	12	10

Dimensión
Product size

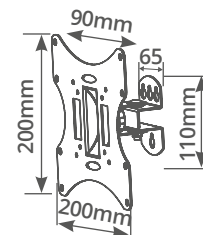
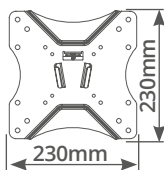

SOPORTE TV PARED CON BRAZO

TV wall mount swiveling arm

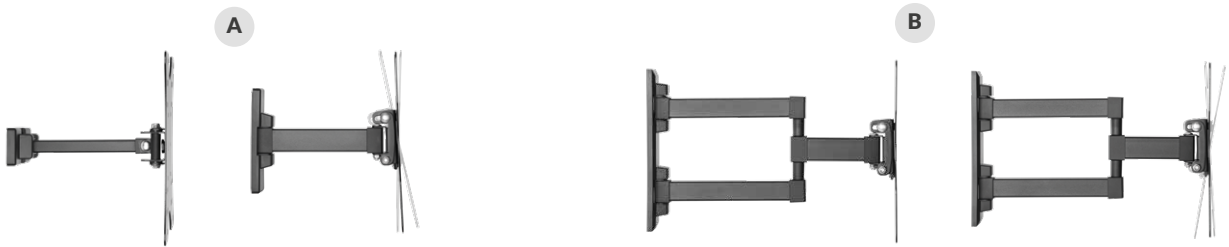
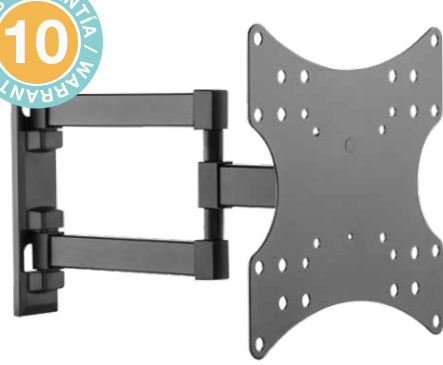
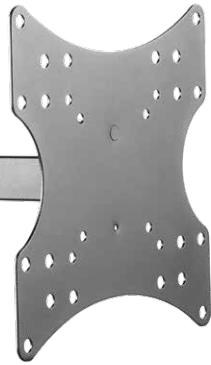

A

B

Referencia / Reference	500055005	500055006
Descripción / Description	Sporte TV con brazo TV wall mount swiveling arm	Sporte TV con brazo doble TV wall mount swiveling arm
Pulgadas / Inch	23" - 42"	23" - 42"
Peso máximo Maximum weight	20Kg / 44lbs	20Kg / 44lbs
VESA	75x75 / 100x100 / 100x150 150x100 / 150x150 / 200x100 / 200x200	75x75 / 100x100 / 100x150 150x100 / 150x150 / 200x100 / 200x200
Inclinación arriba/abajo Tilt up / down	+3° / -10°	+3° / -10°
Oscilación lateral Oscillation	±90°	±90°
Ajuste nivel de pantalla Screen level adjustment	±3°	±3°
Material / Material	Acero + plástico / Steel + plastic	Acero + plástico / Steel + plastic
Apto para pantalla planas y curvas Flat and curved TV	Sí / Yes	Sí / Yes
Distancia / Distance	44-192mm	44-320mm
Color / Color	Negro / Black	Negro / Black
Brazo regulable Adjustable arm	180°	180°
Embalaje / Packaging	14	10

Dimensión
Product size

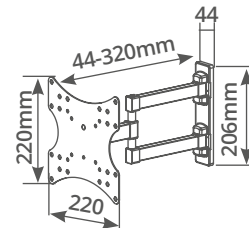
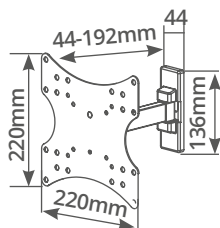

SOPORTE TV PARED FIJO

Fixed TV wall mount

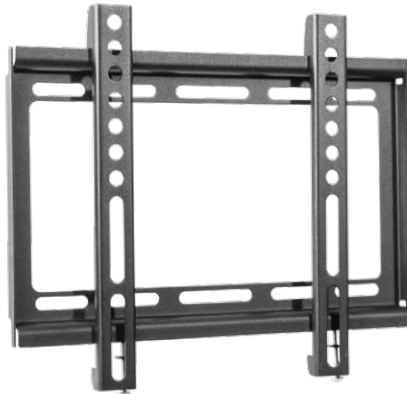

C



Robusto, compacto y fabricado para durar. Extrafino.

Rugged, compact, and built to last. Super slim.

C

Referencia / Reference	500055007
Descripción / Description	Soporte TV fijo Fixed TV wall mount
Pulgadas / Inch	23" - 42"
Peso máximo Maximum weight	35Kg / 77lbs
VESA	50x50 / 75x75 100x100 / 200x100 / 200x200
Inclinación arriba/abajo Tilt up / down	-
Oscilación lateral Oscillation	-
Ajuste nivel de pantalla Screen level adjustment	-
Material / Material	Acero / Steel
Apto para pantalla planas y curvas Flat and curved TV	-
Distancia / Distance	19.5mm
Color / Color	Negro / Black
Brazo regulable Adjustable arm	No
Embalaje / Packaging	20

Dimensión
Product size

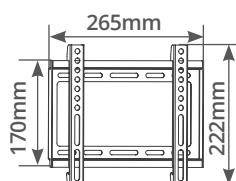

SOPORTE TV PARED

TV wall mount

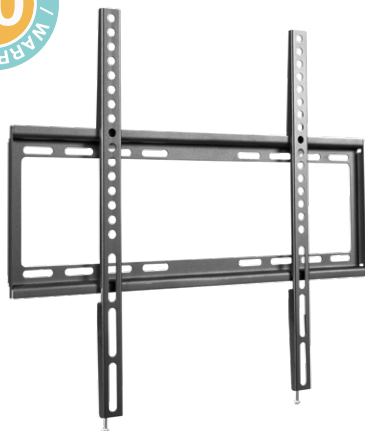

Extrafino.
Super slim.

A



Extrafino.
Super slim.

B

	A	B
Referencia / Reference	500055008	500055010
Descripción / Description	Soporte TV fijo Fixed TV wall mount	Soporte pared TV TV wall mount
Pulgadas / Inch	32" - 55"	32" - 55"
Peso máximo Maximum weight	35Kg / 77lbs	35Kg / 77lbs
VESA	200x200 / 300x300 400x200 / 400x400	200x200 / 300x300 400x200 / 400x400
Inclinación arriba/abajo Tilt up / down	-	+0° / -8°
Oscilación lateral Oscillation	-	-
Ajuste nivel de pantalla Screen level adjustment	-	-
Material / Material	Acero / Steel	Acero + plástico / Steel + plastic
Apto para pantalla planas y curvas Flat and curved TV	-	-
Distancia / Distance	19.5mm	20.5mm
Color / Color	Negro / Black	Negro / Black
Brazo regulable Adjustable arm	-	-
Embalaje / Packaging	12	12

Dimensión
Product size

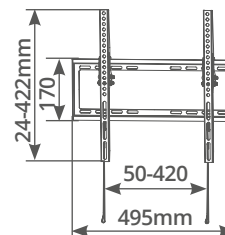
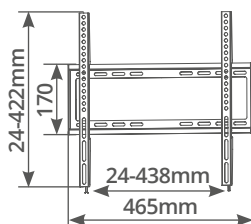

SOPORTE TV PARED CON BRAZO

TV wall mount swiveling arm



C



C

Flexibilidad de movimiento para alcanzar la posición perfecta.

Flexibility of movement to reach the perfect position.

Referencia / Reference	500055012
Descripción / Description	Soporte TV con brazo Full-motion TV wall mount
Pulgadas / Inch	32" - 55"
Peso máximo Maximum weight	35Kg / 77lbs
VESA	75x75 / 100x100 / 100x150 / 100x200 / 150x100 150x150 / 200x100 / 200x200 / 300x200 / 300x300 400x200 / 400x300 / 400x400
Inclinación arriba/abajo Tilt up / down	+10° / -15°
Oscilación lateral Oscillation	±90°
Ajuste nivel de pantalla Screen level adjustment	±3°
Material / Material	Acero + plástico / Steel + plastic
Apto para pantalla planas y curvas Flat and curved TV	Sí / Yes
Distancia / Distance	71-431mm
Color / Color	Negro / Black
Brazo regulable Adjustable arm	Sí / Yes
Embalaje / Packaging	6

**Dimensión
Product size**

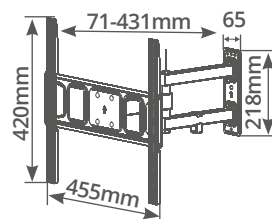

SOPORTE TV PARED

TV wall mount



A



B

	A	B
Referencia / Reference	500055009	500055011
Descripción / Description	Soporte TV fijo Fixed TV wall mount	Soporte pared TV TV wall mount
Pulgadas / Inch	37" - 70"	37" - 70"
Peso máximo / Maximum weight	35Kg / 77lbs	35Kg / 77lbs
VESA	200x200 / 300x300 400x200 / 400x400 / 600x400	200x200 / 300x300 400x200 / 400x400 / 600x400
Inclinación arriba/abajo / Tilt up / down	-	+0° / -8°
Oscilación lateral / Oscillation	-	-
Ajuste nivel de pantalla / Screen level adjustment	-	-
Material / Material	Acero / Steel	Acero + plástico / Steel + plastic
Apto para pantalla planas y curvas / Flat and curved TV	-	-
Distancia / Distance	19.5mm	20.5mm
Color / Color	Negro / Black	Negro / Black
Brazo regulable / Adjustable arm	-	-
Embalaje / Packaging	10	10

Dimensión / Product size

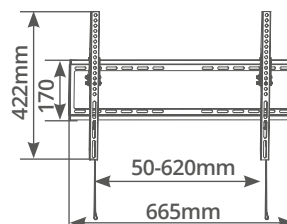
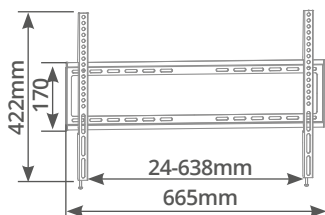

SOPORTE TV PARED CON BRAZO

TV wall mount swiveling arm

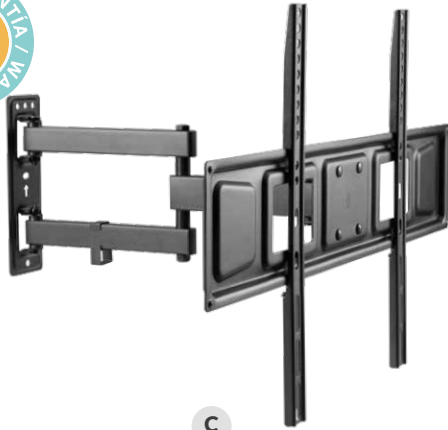

C



D

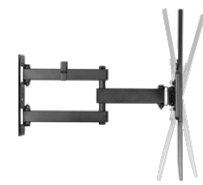
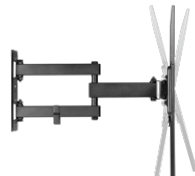

C

D

Referencia / Reference	500055013	500055018
Descripción / Description	Soporte TV con brazo Full-motion TV wall mount	Soporte TV con brazo doble Full-motion TV wall mount
Pulgadas / Inch	37" - 70"	32" - 70"
Peso máximo Maximum weight	35Kg / 77lbs	40Kg / 88lbs
VESA	75x75 / 100x100 / 100x150 / 100x200 150x100 / 150x150 / 200x100 / 200x200 / 300x200 300x300 / 400x200 / 400x300 / 400x400 / 600x400	75x75 / 100x100 / 100x150 / 100x200 150x100 / 150x150 / 200x100 / 200x200 / 300x200 300x300 / 400x200 / 400x300 / 400x400
Inclinación arriba/abajo Tilt up / down	+10° / -15°	+5° / -15°
Oscilación lateral Oscillation	±90°	±60°
Ajuste nivel de pantalla Screen level adjustment	±3°	±3°
Material / Material	Acero + plástico / Steel + plastic	Acero / Steel
Apto para pantalla planas y curvas Flat and curved TV	Sí / Yes	Sí / Yes
Distancia / Distance	71-431mm	62-468mm
Color / Color	Negro / Black	Negro / Black
Brazo regulable Adjustable arm	Sí / Yes	Sí / Yes
Embalaje / Packaging	4	4

**Dimensión
Product size**

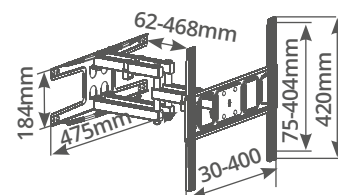
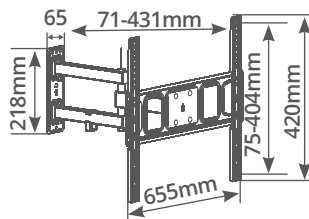

SOPORTE TV PARED PRO CON BRAZO

TV wall mount swiveling arm



**Máxima fuerza de sujeción.
Movimiento fluido.**

Maximum clamping force.
Fluid movement.

Referencia / Reference	500055020
Descripción / Description	Soporte TV PRO con brazo TV wall mount swiveling arm
Pulgadas / Inch	37" - 80"
Peso máximo Maximum weight	50Kg / 110lbs
VESA	200x200 / 300x300 400x200 / 400x400 / 600x400
Inclinación arriba/abajo Tilt up / down	+5° / -15°
Oscilación lateral Oscillation	±60°
Ajuste nivel de pantalla Screen level adjustment	±2.5°
Material / Material	Hierro + Aluminio + Plástico Iron + Steel + Plastic
Apto para pantalla planas y curvas Flat and curved TV	Sí / Yes
Distancia / Distance	53-518mm
Color / Color	Negro / Black
Brazo regulable Adjustable arm	Sí / Yes
Imán en la base Magnet on base	-
Embalaje / Packaging	2

**Dimensión
Product size**

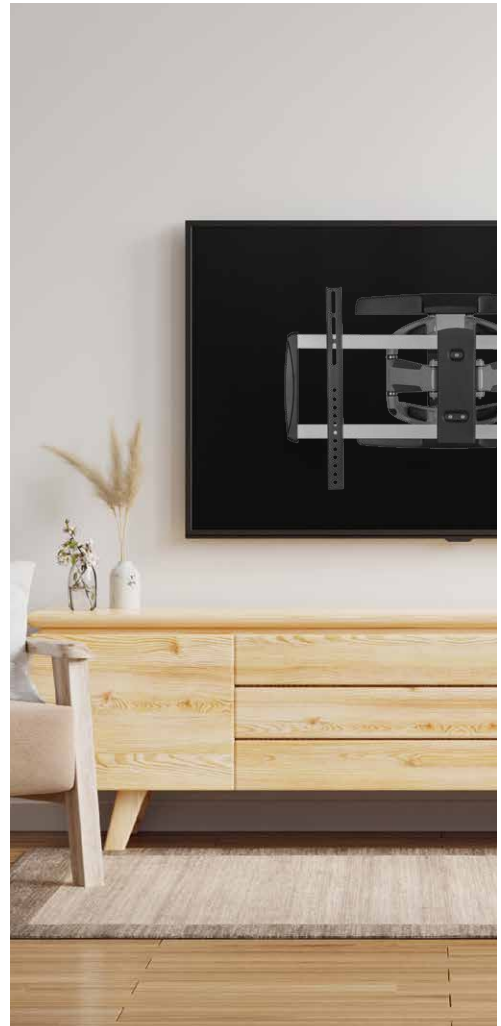
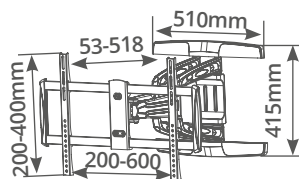

SOPORTE TV PARED PRO CON BRAZO

TV wall mount swiveling arm



Potente imán
Powerful magnet



Diseño elegante con cierre magnético.
Movimiento suave, preciso y fluido.

Elegant design with magnetic closure.
Smooth, precise and fluid movement.

Referencia / Reference	500055019
Descripción / Description	Soporte TV PRO con brazo TV wall mount swiveling arm
Pulgadas / Inch	37" - 80"
Peso máximo Maximum weight	45Kg / 99lbs
VESA	200x200 / 300x200 / 300x300 400x200 / 400x300 / 400x400 / 600x400
Inclinación arriba/abajo Tilt up / down	+5° / -10°
Oscilación lateral Oscillation	±60°
Ajuste nivel de pantalla Screen level adjustment	±3°
Material / Material	Acero / Steel
Apto para pantalla planas y curvas Flat and curved TV	Sí / Yes
Distancia / Distance	80-520mm
Color / Color	Negro / Black
Brazo regulable Adjustable arm	Sí / Yes
Imán en la base Magnet on base	Sí / Yes
Embalaje / Packaging	3

**Dimensión
Product size**

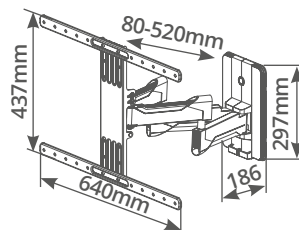

SOPORTE TV PARED CON BRAZO SLIM

Slim TV wall mount swiveling arm



Ultrafino sólo le separan 23mm de la pared
Ultra-thin only 23mm from the wall

Referencia / Reference	500055027
Descripción / Description	Soporte TV con brazo slim Slim TV wall mount swiveling arm
Pulgadas / Inch	37" - 90"
Peso máximo / Maximum weight	50Kg / 110lbs
VESA	200x200 / 200x300 / 300x200 / 200x400 400x200 / 300x300 / 300x400 / 400x300 600x200 / 400x400 / 600x300 / 600x400
Inclinación arriba/abajo / Tilt up / down	+0° / -10°
Oscilación lateral / Oscillation	±30°
Ajuste nivel de pantalla / Screen level adjustment	±1°
Material / Material	Aluminio + Acero + Plástico Aluminium + Steel + Plastic
Apto para pantalla planas y curvas / Flat and curved TV	Sí / Yes
Distancia / Distance	23-2260mm
Color / Color	Negro / Black
Brazo regulable / Adjustable arm	Sí / Yes
Indicador de dirección / Direction indicator	Sí / Yes
Embalaje / Packaging	3

El soporte más slim de su gama con doble brazo para adaptarse a cualquier posición.

The slimmest support in its range with double arm to adapt to any position.

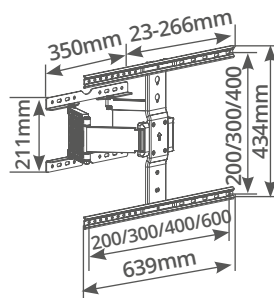

SOPORTE TV PARED CON BRAZO EXTRALARGO

TV wall mount swiveling arm



Con brazo extra largo

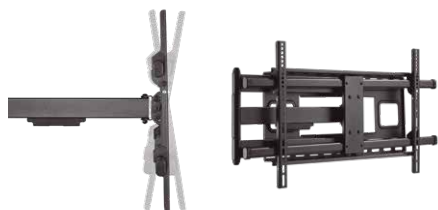
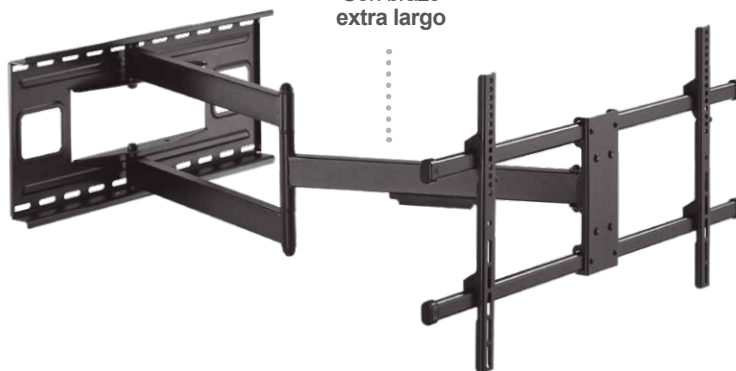

Diseño elegante con cierre magnético. Movimiento suave, preciso y fluido.

Elegant design with magnetic closure. Smooth, precise and fluid movement.

Referencia / Reference	500055028
Descripción / Description	Soporte TV con brazo extralargo TV wall mount swiveling arm
Pulgadas / Inch	43" - 80"
Peso máximo / Maximum weight	50Kg / 110lbs
VESA	200x200 / 300x200 / 300x300 / 400x200 400x300 / 400x400 / 600x400 / 800x400
Inclinación arriba/abajo / Tilt up / down	+5° / -15°
Oscilación lateral / Oscillation	±90°
Ajuste nivel de pantalla / Screen level adjustment	±3°
Material / Material	Acero / Steel
Apto para pantalla planas y curvas / Flat and curved TV	Sí / Yes
Distancia / Distance	82-1015mm
Color / Color	Negro / Black
Brazo regulable / Adjustable arm	Sí / Yes
Embalaje / Packaging	2



Dimensión / Product size

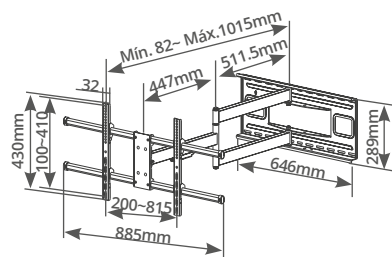

SOPORTE TV PARED CON BRAZO

TV wall mount swiveling arm

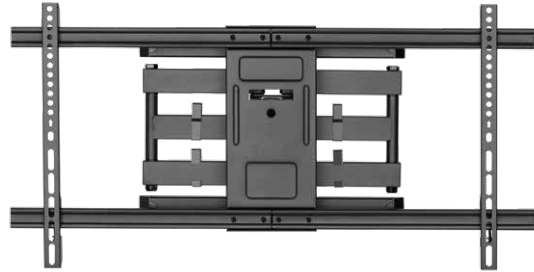

El soporte más robusto de la gama. Plegado perfecto.

The most robust bracket in the range. Perfect folding.

Referencia / Reference	500055023
Descripción / Description	Soporte TV con brazo TV wall mount swiveling arm
Pulgadas / Inch	43" - 90"
Peso máximo Maximum weight	60Kg / 132lbs
VESA	300x200 / 300x300 / 400x200 400x300 / 400x400 / 600x400 / 800x400
Inclinación arriba/abajo Tilt up / down	+3° / -15°
Oscilación lateral Oscillation	±60°
Ajuste nivel de pantalla Screen level adjustment	±3°
Material / Material	Acero + plástico / Steel + plastic
Apto para pantalla planas y curvas Flat and curved TV	Sí / Yes
Distancia / Distance	77-428mm
Color / Color	Negro / Black
Brazo regulable Adjustable arm	Sí / Yes
Embalaje / Packaging	2

Dimensión
Product size

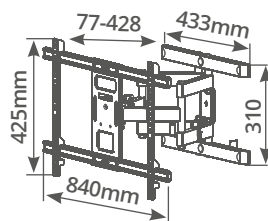

SOPORTE TV PARED FIJO HEAVY DUTY

Fixed TV wall mount heavy duty

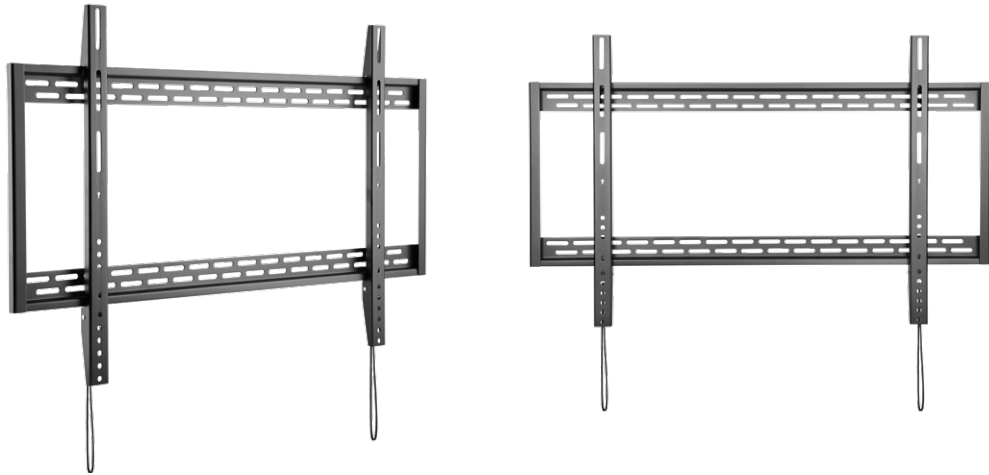

Descubre la nueva gama Heavy Duty que soporta hasta 100Kg.

Discover the new Heavy Duty range that supports up to 100Kg.

Referencia / Reference	500055025
Descripción / Description	Soporte TV fijo Heavy Duty Fixed TV wall mount Heavy Duty
Pulgadas / Inch	60" - 100"
Peso máximo Maximum weight	100Kg / 220lbs
VESA	200x200 / 400x200 / 300x300 / 400x400 600x400 / 800x400 / 800x600 / 900x600
Inclinación arriba/abajo Tilt up / down	-
Oscilación lateral Oscillation	-
Ajuste nivel de pantalla Screen level adjustment	-
Material / Material	Acero / Steel
Apto para pantalla planas y curvas Flat and curved TV	Sí / Yes
Distancia / Distance	32mm
Color / Color	Negro / Black
Brazo regulable Adjustable arm	-
Embalaje / Packaging	3

**Dimensión
Product size**

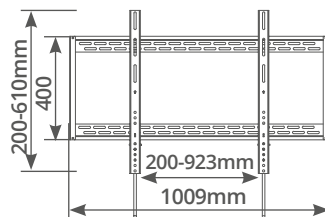

SOPORTE TV PARED HEAVY DUTY

TV wall mount heavy duty

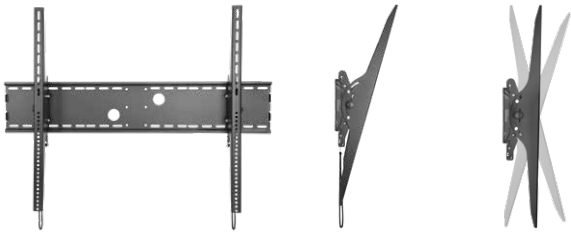

Descubre la nueva gama Heavy Duty que soporta hasta 100Kg.

Discover the new Heavy Duty range that supports up to 100Kg.

Referencia / Reference	500055026
Descripción / Description	Soporte TV Heavy Duty TV wall mount Heavy Duty
Pulgadas / Inch	60" - 100"
Peso máximo / Maximum weight	100Kg / 220lbs
VESA	200x200 / 400x200 / 300x300 / 400x400 600x400 / 800x400 / 600x600 / 1000x400 800x600 / 1000x600 / 800x800 / 1000x800
Inclinación arriba/abajo / Tilt up / down	+15° / -5°
Oscilación lateral / Oscillation	-
Ajuste nivel de pantalla / Screen level adjustment	-
Material / Material	Acero / Steel
Apto para pantalla planas y curvas / Flat and curved TV	-
Distancia / Distance	130mm
Color / Color	Negro / Black
Brazo regulable / Adjustable arm	No
Embalaje / Packaging	2

Dimensión / Product size

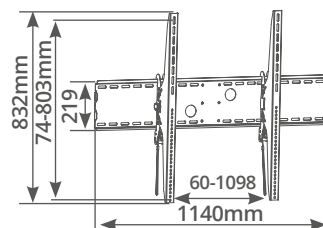

SOPORTE TV ANTIRROBO

Anti theft TV wall mount



A



B

	A	B
Referencia / Reference	500055021	500055022
Descripción / Description	Soporte TV antirrobo Anti theft TV wall mount	Soporte TV antirrobo Anti theft TV wall mount
Pulgadas / Inch	43" - 90"	43" - 90"
Peso máximo Maximum weight	70Kg / 154lbs	70Kg / 154lbs
VESA	200x200 / 300x200 / 300x300 / 400x200 / 400x300 400x400 / 600x400 / 800x400	200x200 / 300x200 / 300x300 / 400x200 400x300 / 400x400 / 600x400 / 800x400
Inclinación arriba/abajo Tilt up / down	-	+3° / -12°
Oscilación lateral Oscillation	-	-
Ajuste nivel de pantalla Screen level adjustment	-	-
Material / Material	Acero / Steel	Acero / Steel
Apto para pantalla planas y curvas Flat and curved TV	Sí / Yes	Sí / Yes
Distancia / Distance	29mm	49mm
Color / Color	Negro / Black	Negro / Black
Sistema antirrobo Anti theft	Sí / Yes	Sí / Yes
Incluye nivel Spirit level	Sí / Yes	Sí / Yes
Embalaje / Packaging	6	6

**Dimensión
Product size**

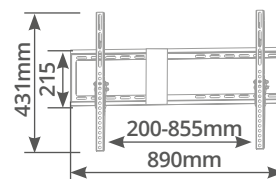
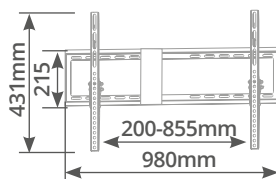

SOPORTE TV PARED ABATIBLE

Folding TV wall mount



**Comodidad y estilo.
Abatible a ambos lados.**

Comfort and style.
Folding on both sides.

Referencia / Reference	500055024
Descripción / Description	Soporte de TV abatible a ambos lados TV wall mount folding on both sides
Pulgadas / Inch	32" - 75"
Peso máximo Maximum weight	50Kg / 110lbs
VESA	200x200 / 200x300 / 300x200 / 200x400 400x200 / 300x300 / 300x400 / 400x300 600x200 / 400x400 / 600x300 / 600x400
Inclinación arriba/abajo Tilt up / down	-
Oscilación lateral Oscillation	+180° / -0°
Ajuste nivel de pantalla Screen level adjustment	-
Material / Material	Acero + Aluminio + Plástico Steel + Aluminium + Plástico
Apto para pantalla planas y curvas Flat and curved TV	Sí / Yes
Distancia / Distance	56mm
Abatible Folding	A ambos lados Both sides
Indicador de dirección Direction indicator	Sí / Yes
Color / Color	Negro / Black
Embalaje / Packaging	3



**Dimensión
Product size**

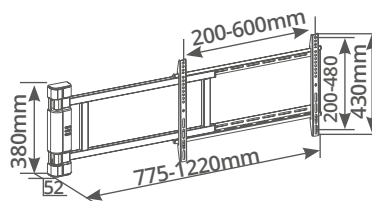

SOPORTES TV PARED MOTORIZADO

Motorized TV wall mount

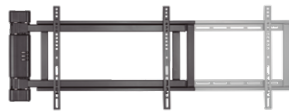

Referencia / Reference	500057003
Descripción / Description	Soporte de TV motorizado Motorized TV wall mount
Pulgadas / Inch	32" - 75"
Peso máximo / Maximum weight	50Kg / 110lbs
VESA	200x200 / 200x300 / 300x200 / 200x400 400x200 / 300x300 / 300x400 / 400x300 600x200 / 400x400 / 600x300 / 600x400
Inclinación arriba/abajo / Tilt up / down	-
Oscilación lateral / Oscillation	+170° / -0°
Ajuste nivel de pantalla / Screen level adjustment	-
Material / Material	Acero + Aluminio + Plástico Steel + Aluminium + Plástic
Apto para pantalla planas y curvas / Flat and curved TV	Sí / Yes
Distancia / Distance	56mm
Abatible / Folding	A ambos lados Both sides
Mando / Remote control	Sí / Yes 2 x AAA (No incl.)
Cable / Cable	1.5M
Color / Color	Negro / Black
Alimentación / Power supply	100-240V~ 50/60Hz DC 12V 1A
Embalaje / Packaging	3



Dimensión / Product size

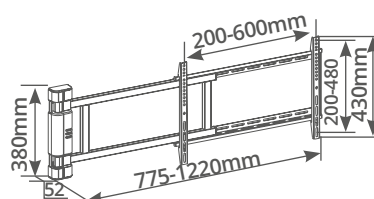

SOPORTES TV ELEVADOR MOTORIZADO

Motorized TV lift mount



Función anti-colisión.
Altura regulable 87~273mm.

Anti-collision function.
Adjustable height 87~273mm.

Referencia / Reference	500057004
Descripción / Description	Soporte elevador de TV motorizado Smart motorized lift mount
Pulgadas / Inch	37" - 80"
Peso máximo Maximum weight	60Kg / 132lbs
VESA	200x200 / 200x300 / 300x200 / 200x400 / 400x200 300x300 / 300x400 / 400x300 / 600x200 / 350x350 400x400 / 600x300 / 400x600 / 600x400
Material Material	Acero + Plástico Steel + Plástic
Apto para pantalla planas Flat TV	Sí / Yes
Altura regulable Adjustable height	87~273mm
Función anti-colisión Anti-collision function	Sí / Yes
Mando / Remote control	Sí / Yes 2 x AAA (No incl.)
Cable / Cable	1.5M
Color / Color	Negro / Black
Alimentación / Power supply	100-240V~ 50/60Hz DC 29V 1.8A
Embalaje / Packaging	2



Dimensión
Product size

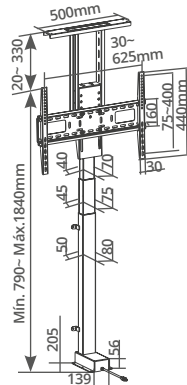

SOPORTES TV TECHO MOTORIZADO

Motorized TV ceiling mount



La mejor solución para techos inclinados. Plegado perfecto.

The best solution for sloping ceiling. Perfect folding.



Referencia / Reference	500057001
Descripción / Description	Soporte de TV motorizado Motorized TV ceiling mount
Pulgadas / Inch	32" - 70"
Peso máximo Maximum weight	35Kg / 77lbs
VESA	200x100 / 200x200 / 200x400 / 300x200 / 300x300 400x200 / 400x300 / 400x400 / 600x400
Inclinación arriba/abajo Tilt up / down	+0° / -75°
Oscilación lateral Oscillation	-
Ajuste nivel de pantalla Screen level adjustment	±2°
Material Material	Acero + Plástico Steel + Plástic
Apto para pantalla planas y curvas Flat and curved TV	Sí / Yes
Montaje techo Ceiling mounting	Plano e inclinado Flat and inclined
Mando / Remote control	Sí / Yes 2 x AAA (No incl.)
Cable / Cable	1.5M
Color / Color	Negro / Black
Alimentación / Power supply	100-240V~ 50/60Hz DC 24V 1.5A
Embalaje / Packaging	2
Dimensión Product size	



SOPORTES TV TECHO GIRATORIO

Swivel TV ceiling mount

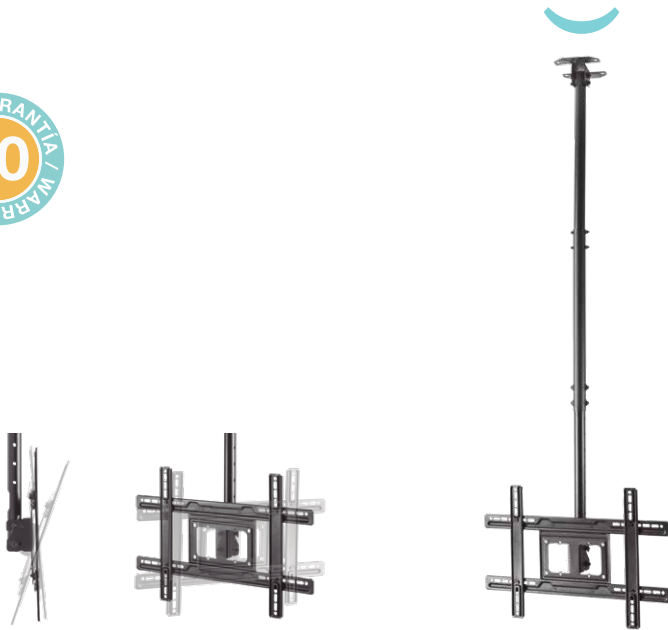

Con brazo extensible hasta 1577mm.
With extendable arm up to 1577mm.

Referencia / Reference	500055022
Descripción / Description	Soporte TV de techo giratorio Swivel ceiling TV mount
Pulgadas / Inch	37" - 80"
Peso máximo / Maximum weight	50Kg / 110lbs
VESA	200x200 / 300x200 / 400x200 / 300x300 400x300 / 400x400 / 600x400
Inclinación arriba/abajo / Tilt up / down	+5° / -25°
Oscilación lateral / Oscillation	±90°
Ajuste nivel de pantalla / Screen level adjustment	±3°
Material / Material	Acero + Plástico Steel + Plástic
Apto para pantalla planas / Flat TV	Sí / Yes
Montaje techo / Ceiling mounting	Sí / Yes
Color / Color	Negro / Black
Embalaje / Packaging	2

Dimensión / Product size

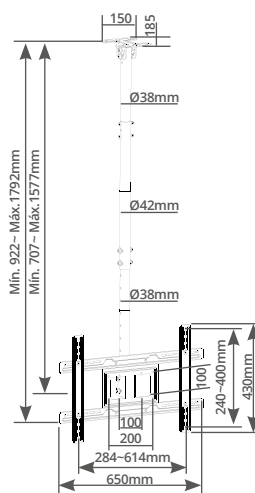

SOPORTES TV PIE

Floor TV stand



Referencia / Reference	50006000
Descripción / Description	Soporte de pie fijo Easel studio TV floor stand
Pulgadas / Inch	49" - 70"
Peso máximo / Maximum weight	40Kg / 88lbs
VESA	200x200 / 300x200 / 300x300 400x200 / 400x300 / 400x400 / 600x400
Oscilación lateral / Oscillation	-
Material / Material	Acero + Aluminio + Plástico Steel + Aluminium + Plástic
Altura máxima / Maximum height	1345mm
Indicador de dirección / Direction indicator	Si / Yes
Color / Color	Negro / Black
Material patas / Leg material	-
Embalaje / Packaging	2

Dimensión / Product size

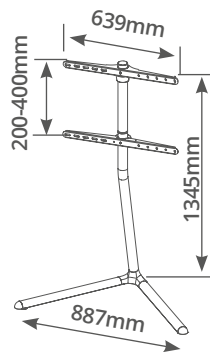

SOPORTES TV PIE

Floor TV stand



Referencia / Reference	500060001
Descripción / Description	Soporte de pie tipo trípode Easel studio TV floor stand
Pulgadas / Inch	50" - 65"
Peso máximo Maximum weight	35Kg / 77lbs
VESA	200x200 / 300x200 / 300x300 400x200 / 400x300 / 400x400
Oscilación lateral Oscillation	±70°
Material / Material	Acero + Aluminio + Plástico Steel + Aluminium + Plástic
Altura máxima Maximum height	1347mm
Indicador de dirección Direction indicator	Sí / Yes
Color / Color	Negro + Cerezo / Black + Brown
Material patas Leg material	Madera / Wood
Embalaje / Packaging	2

**Dimensión
Product size**

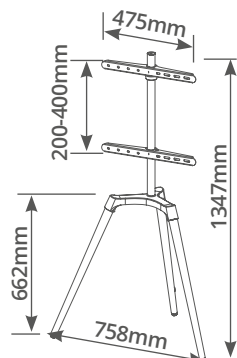

SOPORTES TV PIE

Floor TV stand



Ref. 500060004
Estante accesorios
Accessory shelf

(Se vende por separado)
(Sold separately)

Referencia / Reference	500060003
Descripción / Description	Soporte de pie con ruedas TV cart
Pulgadas / Inch	37" - 70"
Peso máximo Maximum weight	50Kg / 110lbs
VESA	100x100 / 200x100 / 200x200 / 300x200 / 300x300 400x200 / 400x300 / 400x400 / 600x400
Inclinación Tilt	+5° / -12°
Material / Material	Acero + Aluminio + Plástico Steel + Aluminium + Plástic
Altura máxima Maximum height	1665mm
Indicador de dirección Direction indicator	-
Color / Color	Negro / Black
Posiciones Positons	4 fijas / 4 fixed
Embalaje / Packaging	1

**Dimensión
Product size**

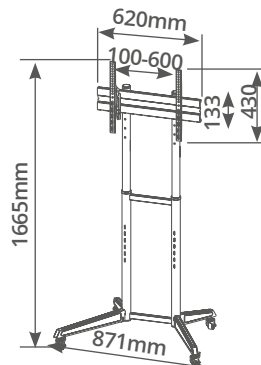

SOPORTES TV PIE

Floor TV stand



Referencia / Reference	500060005
Descripción / Description	Soporte de pie con ruedas TV cart
Pulgadas / Inch	45" - 90"
Peso máximo Maximum weight	60Kg / 132lbs
Peso máximo estantería Maximum shelf weight	10Kg / 22lbs
VESA	200x100 / 100x200 / 100x100 / 200x200 / 75x75 300x200 / 400x200 / 300x300 / 400x300 / 400x400 600x400 / 800x400
Material / Material	Acero+ Plástico Steel + Plástico
Indicador de dirección Direction indicator	-
Color / Color	Negro / Black
Embalaje / Packaging	1



**Dimensión
Product size**

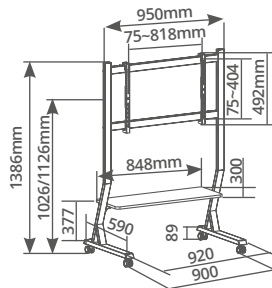

SOPORTES PATAS TV

Floor TV stand



Referencia / Reference	500060006
Descripción / Description	Soporte patas sobremesa Tabletop leg support
Pulgadas / Inch	23" - 75"
Peso máximo Maximum weight	40Kg / 88lbs
VESA	200x100 / 100x200 / 100x100 / 200x200 / 75x75 300x200 / 400x200 / 300x300 / 400x300 / 400x400 600x400 / 800x400
Material / Material	Acero + Plástico Steel + Plástic
Indicador de dirección Direction indicator	-
Color / Color	Negro / Black
Embalaje / Packaging	8

Dimensión
Product size

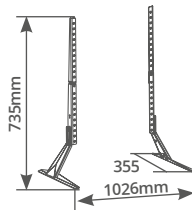

SOPORTES DE TECHO

TV ceiling mount



A



B

	A	B
Referencia / Reference	500075000	500055015
Descripción / Description	Soporte techo para proyector Projector ceiling mount	Soporte techo para TV TV ceiling mount
Pulgadas / Inch	-	32" - 55"
Peso máximo Maximum weight	20Kg / 44lbs	50Kg / 110lbs
VESA	-	200x200 / 300x300 400x200 / 400x400
Inclinación arriba/abajo Tilt up / down	±15°	+0° / -25°
Oscilación lateral Oscillation	±8°	±180°
Ajuste nivel de pantalla Screen level adjustment	-	-
Material / Material	Acero / Steel	Acero / Steel
Apto para pantalla planas y curvas Flat and curved TV	Sí / Yes	Sí / Yes
Color / Color	Negro / Black	Negro / Black
Instalación Installation	En techo Ceiling	En techo plano o inclinado Flat or inclined ceiling
Altura regulable Adjustable height	-	Sí / Yes
Embalaje / Packaging	10	3

**Dimensión
Product size**

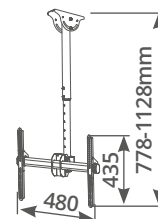
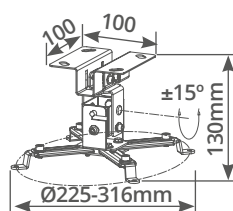

SOPORTES ELEVADORES MONITORES

Monitor desk mount



C

Superficie ventilada y resistente. 3 niveles de altura.

Ventilated and resistant surface. 3 levels of height.



D



E

	C	D	E
Referencia / Reference	500080002	500080000	500080001
Descripción / Description	Soporte metálico elevador de monitor Steel monitor desk mount	Soporte elevador de monitor Monitor desk mount	Soporte elevador de monitor Monitor desk mount
Peso máximo Maximum weight	20Kg / 44lbs	20Kg / 44lbs	20Kg / 44lbs
Material / Material	Acero + Plástico / Steel + Plastic	Vidrio + ABS / Glass + ABS	Vidrio + ABS / Glass + ABS
Almohadillas antideslizantes / Non-slip silicones pads	Sí / Yes	Sí / Yes	Sí / Yes
Altura regulable Adjustable height	100 / 120 / 140mm	-	-
Color / Color	Negro / Black	Transparente / Transparent	Negro / Black
Embalaje / Packaging	14	5	5

**Dimensión
Product size**

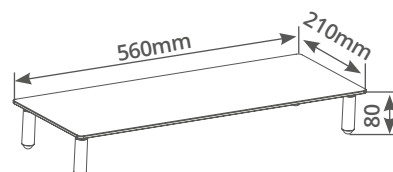
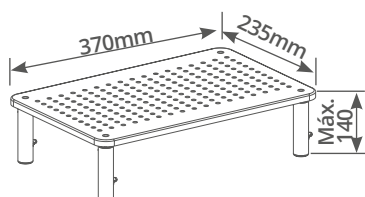

SOPORTES TV / MONITOR CON BRAZO

Articulated monitor support



A



B



C

	A	B	C
Referencia / Reference	500080003	500080004	500080005
Descripción / Description	Soporte TV / Monitor con brazo articulado Articulated monitor support	Soporte TV / Monitor con doble brazo articulado Articulated monitor support	Soporte TV / Monitor con brazo articulado Articulated monitor support
Pulgadas / Inch	13" - 32"	13" - 32"	13" - 27"
Peso máximo Maximum weight	8Kg / 17.6lbs	8Kg / 17.6lbs	6.5Kg / 14.3lbs
VESA	75x75 / 100x100	75x75 / 100x100	75x75 / 100x100
Inclinación arriba/abajo Tilt up / down	±45°	±45°	±45°
Oscilación lateral Oscillation	±90°	±180°	±90°
Ajuste nivel de pantalla Screen level adjustment	±360°	±90°	±360°
Material / Material	Acero / Steel	Acero / Steel	Acero / Steel
Amortiguador de gas Gas spring	-	-	Sí / Yes
Color / Color	Negro / Black	Negro / Black	Negro / Black
Embalaje / Packaging	1	1	1

Dimensión Product size

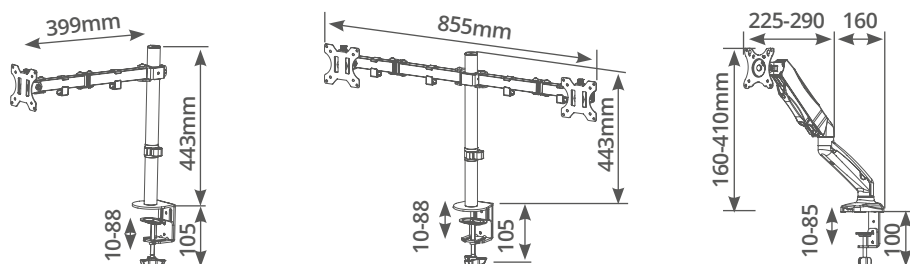

SOPORTES PC

PC mounts



D



E



Altura regulable.
Adjustable height.



Soporte regulable en altura y profundidad.
Height and depth adjustable holder.

	D	E
Referencia / Reference	500080006	500080008
Descripción / Description	Soporte TV o monitor Monitor desk stand	Soporte CPU bajo mesa CPU holder
Pulgadas / Inch	17" - 27"	-
Peso máximo Maximum weight	7Kg / 15lbs	10Kg / 22lbs
VESA	75x75 / 100x100	-
Inclinación arriba/abajo Tilt up / down	±10°	-
Oscilación lateral Oscillation	±45°	360°
Ajuste nivel de pantalla Screen level adjustment	±180°	-
Material / Material	Acero + Plástico / Steel + Plastic	Acero / Steel
Color / Color	Negro / Black	Negro / Black
Altura regulable Adjustable height	Sí / Yes	300-533mm
Profundidad regulable Adjustable depth	-	88-203mm
Organizador de cables Cable organizer	Sí / Yes	-
Embalaje / Packaging	10	6

Dimensión
Product size

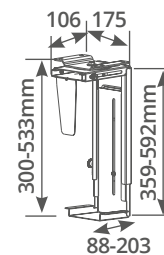
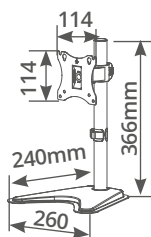

ACCESORIOS PARA TV

TV accessories



A



B



C



Aflojar la perilla y ajustar la pata.

Loosen the knob and adjust the bar.



Con base antideslizante.

With non-slip base.



	A	B	C
Referencia / Reference	500090004	500090005	500090006
Descripción / Description	Estante simple para accesorios TV Simple shelf for TV accessories	Estante doble para accesorios TV Double shelf for TV accessories	Soporte trasero para accesorios TV Rear bracket for TV accessories
Peso máximo / Maximum weight	6Kg / 13lbs	6Kg / 13lbs	2Kg / 4lbs
Material / Material	Plástico / Plastic	Plástico / Plastic	Acero / Steel
Instalación / Installation	Con perilla / With knob	Con perilla / With knob	Con tornillos / With screws
Para / For	TV sin soporte For TV without stands	TV sin soporte For TV without stands	TV sin soporte For TV without stands
Color / Color	Negro / Black	Negro / Black	Negro / Black
Embalaje / Packaging	40	20	10

Dimensión / Product size

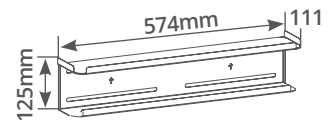
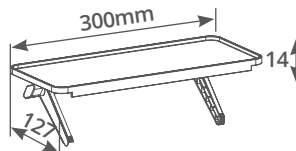
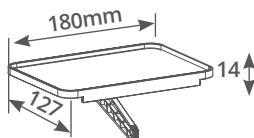

SOPORTES BARRA SONIDO

Soundbar bracket



D

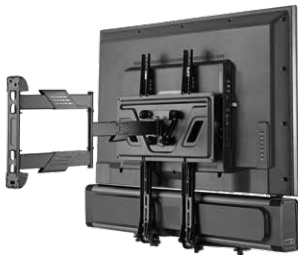

Optimiza el espacio y dirige el sonido en la posición correcta. Montaje sobre o bajo la TV.

Optimize the space and direct the sound in the correct position. Mount above or below the TV.

D

Referencia / Reference	500091000
Descripción / Description	Soporte barra de sonido Sound bar bracket
Peso máximo / Maximum weight	15Kg / 33lbs
Material	Acero + Plástico Steel + Plastic
Distancia / Distance	77-215mm
Color / Color	Negro / Black
Instalación / Installation	Sobre o bajo la TV Above or below the TV
Anchura regulable / Adjustable width	40-182mm
Para barras de sonido de / For soundbars	580-1143mm
Embalaje / Packaging	10

Dimensión / Product size

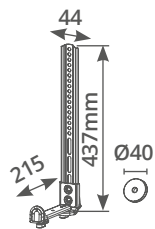

SOPORTES MULTIMEDIA

Multimedia supports



A



B



Multi-ángulo.
Con soporte para reloj.
Multi-angle.
With watch holder.

A

B

	A	B
Referencia / Reference	500080009	500090007
Descripción / Description	Soporte elevador portátil Laptop stand	Soporte móvil o tablet multiángulo Mobile or tablet support multi-angle
Pulgadas / Inch	10" - 15"	Máx. 10"
Peso máximo Maximum weight	5Kg / 11lbs	5Kg / 11lbs
Posiciones / Positions	15° / 45° / 60°	Multi-ángulo / Multi-angle
Material / Material	Acero / Steel	Acero / Steel
Color / Color	Negro / Black	Gris / Gray
Mecanismo de plegado Folding setting	Sí / Yes	Sí / Yes
Silicona antideslizante Non-slip silicone	Sí / Yes	Sí / Yes
Embalaje / Packaging	20	100

Dimensión
Product size

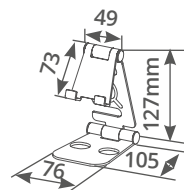
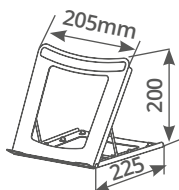

SOPORTES VARIOS

Various brackets



C



D



Escuadra plegable.
Folding square.

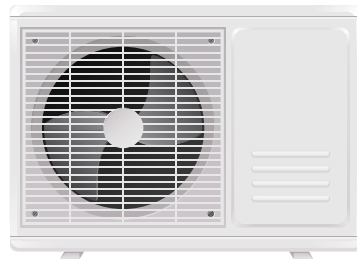

Soporta hasta 200Kg.
Supports up to 200Kg.

	C	D
Referencia / Reference	500090003	500085001
Descripción / Description	Escuadra estante plegable Folding wall mounted shelf	Soporte pared para aire acondicionado Air conditioning wall bracket
Peso máximo / Maximum weight	50Kg / 110lbs	200Kg / 440lbs
Distancia entre brazos / Brackets distance	400-800mm	400-800mm
Material / Material	Acero / Steel	SPCC Acero / Steel
Color / Color	Blanco / White	Blanco / White
Plegable / Foldable	Sí / Yes	-
Para aire / For airs	-	1 ~2 HP
Embalaje / Packaging	15	15

Dimensión
Product size

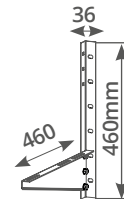
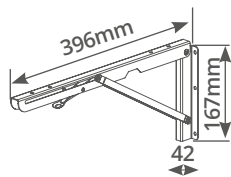

SOPORTES VARIOS

Various brackets



A

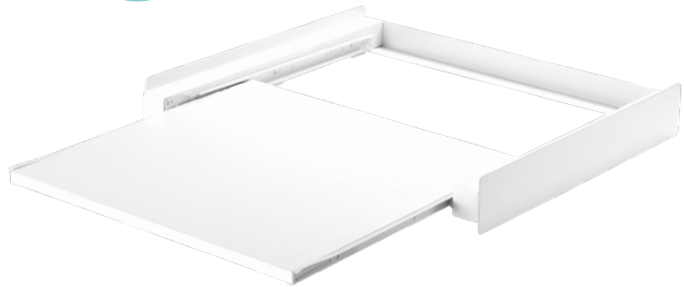

B



Plegable y patas regulables hasta 492mm.

Foldable and adjustable legs up to 492mm.



Bandeja extraíble hasta 8Kg.

Removable tray up to 8 Kg.

	A	B
Referencia / Reference	500850000	500090000
Descripción / Description	Soporte pared para microondas Microwave holder	Soporte unión lavadora y secadora Laundry stacking kit
Peso máximo / Maximum weight	30Kg / 66lbs	60Kg / 132lbs
Material / Material	Acero / Steel	Acero + Aluminio / Steel + Aluminium
Color / Color	Blanco / White	Blanco / White
Plegable / Foldable	Hasta 130mm	-
Extraíble / Removable	325-492mm	Bandeja 8Kg / Pullout tray
Embalaje / Packaging	15	1

Dimensión
Product size

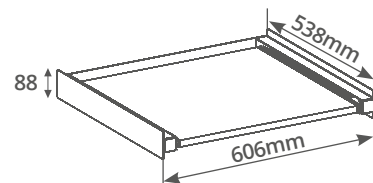
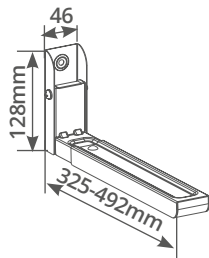

SOPORTES VARIOS

Various brackets



C



D

Ideal para electrodomésticos.

Ideal for household appliances.



	C	D	D
Referencia / Reference	500090013	500090011	500090012
Descripción / Description	Soporte multifuncional con ruedas Multifunctional stand with wheels	Estante organizador de cocina Kitchen organizer rack	Estante organizador de cocina Kitchen organizer rack
Peso máximo / Maximum weight	300Kg / 662lbs	20Kg / 44lbs	20Kg / 44lbs
Material / Material	Plástico + Acero inox. Plastic + Stainless steel	Acero / Steel	Acero / Steel
Color / Color	Blanco / White	Negro / Black	Blanco / White
Anchura regulable / Adjustable width	500-700mm	400-600mm	400-600mm
Colgadores / Hangers	-	8	8
Niveles estante / Shelf levels	-	2	2
Embalaje / Packaging	5	5	5

Dimensión
Product size

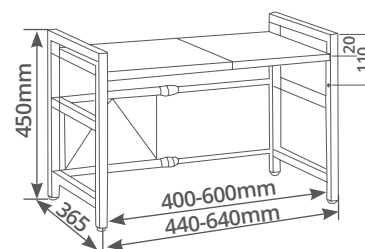
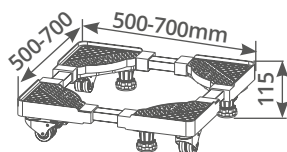

SOPORTES VARIOS

Various brackets



A



B



Ideal para colocar en electrodomésticos.

Ideal to place in household appliances.

*Dispensador no incluido.

A

B

Referencia / Reference	500090002	500090001
Descripción / Description	Organizador objetos con imán para electrodomésticos Magnetic side rack	Soporte dispensador gel hidroalcohólico Hydroalcoholic gel dispenser support
Peso máximo Maximum weight	12Kg / 26.4lbs	5Kg / 11lbs
Material / Material	Acero / Steel	Acero + Plástico / Steel + Plastic
Color / Color	Blanco / White	Blanco / White
Con / With	Imanes para fijar Magnets to fix on appliances	Bandeja antigoteo Drip tray
Embalaje / Packaging	5	1

Dimensión
Product size

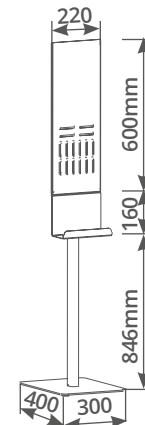
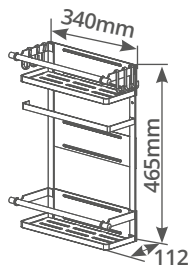

REPOSAPIÉS

Footrest



C



D



E

	C	D	E
Referencia / Reference	500090008	500090009	500090010
Descripción / Description	Reposapiés plataforma ajustable Adjustable office footrest	Reposapiés ajustable en ángulo y altura Adjustable office footrest	Reposapiés acero plataforma ajustable Adjustable office footrest
Peso máximo Maximum weight	25Kg / 55lbs	25Kg / 55lbs	25Kg / 55lbs
Inclinación / Tilt angle	+0 / -15°	+0 / -30°	+0 / -15°
Material / Material	Plástico / Plastic	Plástico / Plastic	Acero + Plástico / Steel + Plastic
Color / Color	Negro / Black	Negro / Black	Negro / Black
Plataforma Platform	Ajustable con presión Adjustable with pressure	Ajustable con palanca Adjustable with lever	Ajustable con presión Adjustable with pressure
Superficie antideslizante Non-slip surface	Sí / Yes	Sí / Yes	Sí / Yes
Reduce la fatiga Reduction of fatigue	Sí / Yes	Sí / Yes	Sí / Yes
Diseño ergonómico Ergonomic design	Sí / Yes	Sí / Yes	Sí / Yes
Embalaje / Packaging	5	5	5

Dimensión
Product size

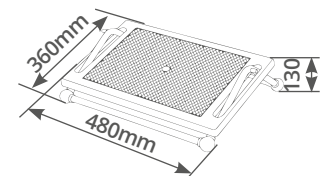
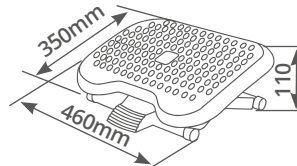
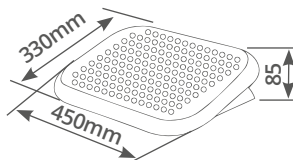

INFORMACIÓN TÉCNICA

Technical information



A continuación te mostramos a través de unos iconos la nomenclatura sobre: **la inclinación, la oscilación, el ajuste de nivel de pantalla y la rotación.**

También puedes consultar los iconos presentes durante el catálogo que hacen referencia a **productos con fácil instalación, con accesorios de instalación incluidos o con organizador de cables.**

*Below we show you through some icons the nomenclature about: **the inclination, the oscillation, the screen level adjustment and the rotation.***

*You can also consult the icons present during the catalogue that refer to **products with easy installation, with included installation accessories or with cable manager.***

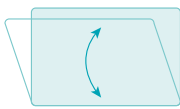

Inclinación arriba /abajo
Tilt up / down

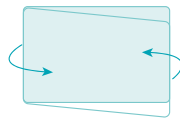

Oscilación lateral
Oscillation

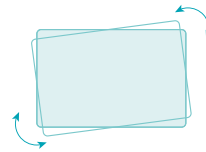

Ajuste nivel de pantalla
Screen level adjustment

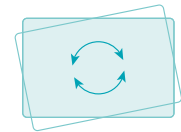

Rotación
Rotation



Fácil instalación
Easy installation



Accesorios instalación incluidos
Installation accessories included



Con organizador de cables
With cable manager



Número de años de garantía
Number of years of warranty



HOLMIOS[®]
EASY SOLUTIONS!

HOLMIOS®

EASY SOLUTIONS FOR YOU!

Easy solutions for your life!

