

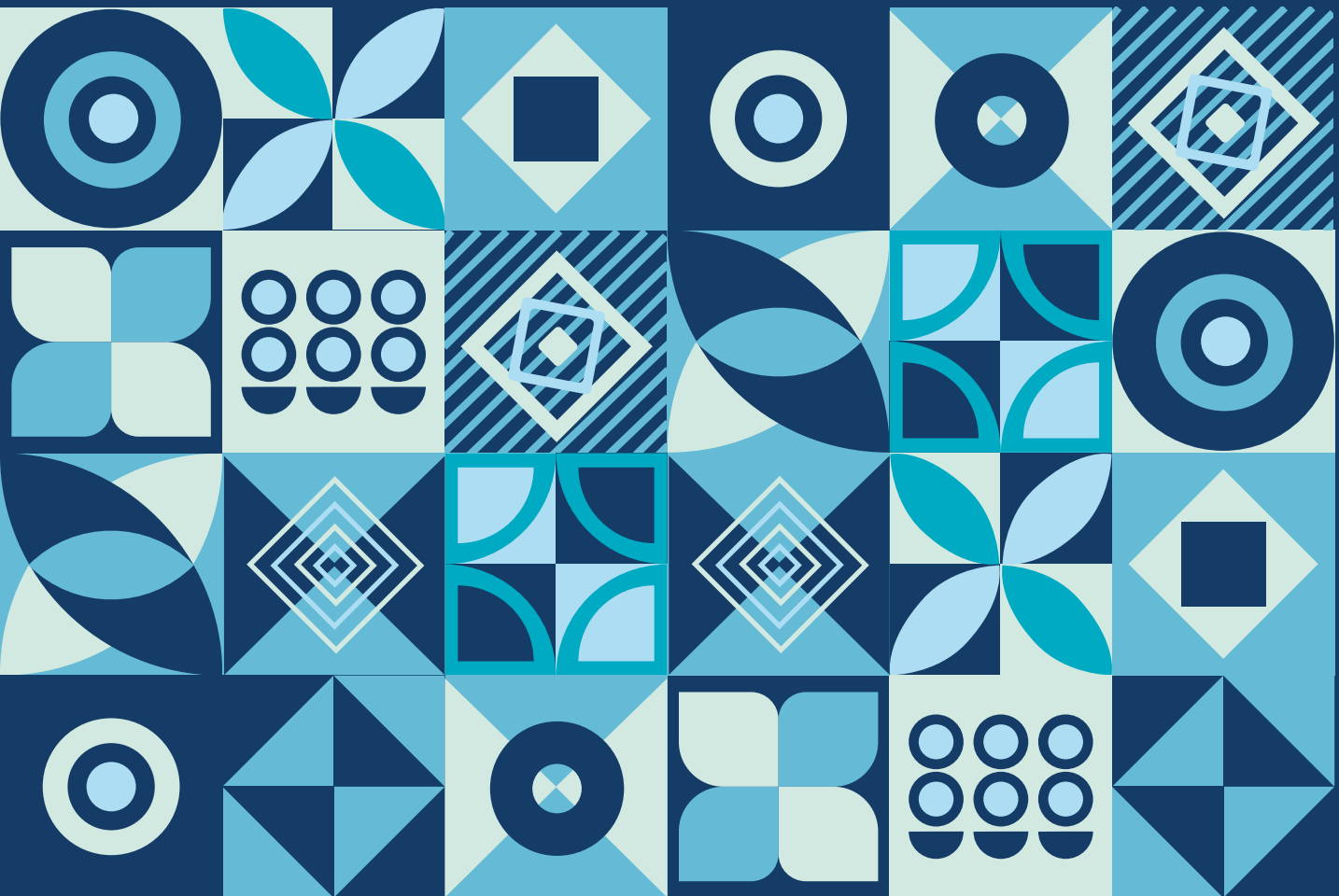

gsc[®]
evolution

Catálogo General

2024





Descárgate
aquí la versión
del catálogo en pdf



LA MARCA QUE TE HACE LA VIDA MÁS FÁCIL!!



El secreto hacia éxito es comenzar el viaje
con pasión, constancia e ilusión.

¿Nos acompañas?

Nosotros estaremos aquí para acompañarte
y hacerte la vida

Easy life!

Fabricantes y distribuidores

Garsaco, una de las **empresas más reconocidas a nivel nacional** en el sector de la iluminación y el material eléctrico.



+ 20 años **colaborando con nuestros clientes**

**Más de 4000 productos
con stock actualizado en tiempo real**

Ponemos a tu alcance una amplia gama de referencias de material eléctrico, iluminación, linternas, detectores, calefacción, ventilación, PAE, accesorios TV, productos Smart, etc.



**Garantía
de fabricante**

Todos nuestros productos cuentan con una garantía de hasta 10 años.

Así mismo, cumplen con todas las normas y requisitos de instalación.



**Atención
orientada
al cliente**

Gracias a nuestra extensa red de agentes, puedes recibir asesoramiento y trato personalizado para cualquier consulta ya sea por email, teléfono o presencial.



**Compromiso
envío en
24 horas**

Realiza tu pedido por la web y asegúrate de que salga de nuestras instalaciones dentro de las siguientes 24 horas laborables.



Innovación y transformación digital 2.0

Con una gran inversión en digitalización, nos preocupamos por facilitar y mejorar la experiencia de nuestros clientes.

Puedes realizar los pedidos donde y cuando quieras a través de nuestra web www.garsaco.com



Te ayudamos a vender más y mejor

Realizamos estudios de mercado para monitorizar la demanda con el objetivo de fabricar productos ganadores que generen grandes beneficios.

Proporcionamos material promocional de apoyo para potenciar tus ventas.



Comprometidos con el medio ambiente

Ofrecemos piezas de repuesto para prolongar la vida útil de nuestros productos.

Optimizamos el embalaje y la logística para los envíos de mercancía.

Buscamos materiales alternativos que tengan una alta reciclabilidad.

Colaboramos con las principales empresas de reciclaje en nuestro país ECOEMBES Y SUNRISE.





¿Todavía no... compras online?

Descubre las **grandes ventajas** de comprar por la web



**Atiéndeles
sin interrupciones**
Tus clientes, lo primero.

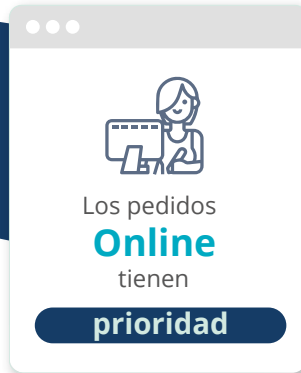

Atención **personalizada**



**Ofertas
exclusivas**
en la web



Descuentos
sin hacer grandes
pedidos



Guarda tu pedido
en el carrito
y sigue en cualquier
momento

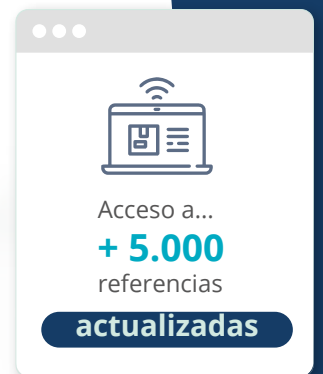

Lo que necesites
**dónde y cuándo
quieras**



**Control
de stock**
al momento





Índice

fotográfico



Material eléctrico



P.17 Bases múltiples



P.18 Interior



P.32 Exterior



P.35 Alargadores de enchufes



P.36 Prolongadores



P.38 Enrollables



P.40 Matériel électrique française



P.41 Multiprises



P.43 Rallonges



P.44 Cables



P.45 Conductores



P.54 Textiles



P.52 Guías pasacables



P.58 Alimentación y conexión



P.61 Conexiones eléctricas y cajas



P.62 Conectores empalme rápido



P.63 Terminales de conexión



P.64 Regletas de conexión



P.65 Terminales de cable



P.72 Prensas estopas



P.73 Conectores estancos



P.74 Cajas conexión estancas



P.75 Cajas de registro



P.78 Sistemas de fijación



P.79 Bridas



P.83 Fijación de cables y tubos



P.86 Fijación de tornillos y tacos



P.87 Canalización y ordenación de cables



P.88 Canaletas



P.92 Organizadores de cables



P.93
Medición eléctrica



P.94
Multímetros



P.97
Comprobadores de voltajes



P.98
Interruptores



P.99
De paso



P.100
Armarios



P.100
De pie



P.101
Mini



P.103
Flotantes



P.104
Casquillos



P.105
Adaptadores conversores



P.106
Portalámparas reforzados



P.107
Portalámparas lisos



P.110
Portalámparas con arandela



P.114
Especiales



P.119
Portalámparas decorativos



P.121
Clavijas y bases aéreas



P.122
Domésticas



P.128
Industriales



P.132
Cetac



P.135
Adaptadores y enchufes



P.136
Adaptadores de viaje



P.137
Ladrones



P.142
Mecanismos



P.143
Domésticos



P.160
Estancos



P.165
Cajas y módulos



P.167
Timbres



P.168
Domésticos



P.172
Industriales



P.173
Detectores y alarmas



P.174
Superficie



P.180
Empotrables



P.185
Alarmas



P.187
Extractores



P.190
Programadores



P.191
Temporizadores



P.194
Minuteros



P.195
Electricidad
y protecciones



P.196
Cuadros
eléctricos



P.197
Magnetotér-
micos



P.199
Diferenciales



P.201
Condensadores



P.203
Telecomunicaciones



P.204
Televisión



P.215
Mandos



P.216
Telefonía



P.218
Internet



P.219
Cables y
cargadores
USB



P.220
Cables



P.222
Cargadores



P.226
Domótica



P.227
Mat. eléctrico



P.237
Iluminación

Iluminación



P.243
Linternas



P.244
Mano



P.247
Cabeza



P.250
Displays



P.258
Trabajo



P.265
Camping



P.268
Señalización



P.270
Interior



P.271
Aritos



P.283
Downlights



P.294
Plafones



P.309
Lámparas
colgantes



P.324
Lámparas
de pie



P.327
Appliques



P.329
Focos
de pared



P.330
Focos
de techo



P.346
Comercial



P.349
Paneles LED



P.363
Regletas LED



P.368
Muebles
y baños



P.374
Pantallas
y regletas
industriales



P.382
Flexos



P.401
Luces
de noche



P.411 Exterior



P.412 Solar



P.426 Proyectores



P.444 Estacas



P.455 Guirnaldas



P.458 Faroles



P.464 Apliques



P.485 Plafones



P.488 Bañadores



P.492 Piscina



P.495 Emergencia



P.496 Luminaria emergencia



P.503 Bombillas LED



P.554 Bombillas industriales



P.499 Bombillas, tubos, campanas y farolas



P.500 Bajo consumo



P.501 Incandescentes y halógenas



P.546 Tubos fluorescentes



P.549 Tubos LED



P.556 Campanas y farolas ind.



P.561 Tiras LED



P.562 Interior



P.563 Exterior



P.569 Decorativas



P.572 Perfiles y accesorios

Soportes



P.585 Soportes y accesorios de TV



P.586 Pared / Techo



P.604 Pie



P.607 Accesorios TV



P.609 Soportes pantallas



P.610 Monitores



P.612 Proyectores



P.613 Tablets / móviles



P.614 Elevadores



P.615 Soportes hogar y oficina



P.616 Hogar



P.620 Reposapiés

Climatización



P.622 Ventilación



P.623
De mano
y USB



P.628
Sobremesa



P.631
De pared



P.633
De pie



P.644
Industriales



P.649
Purificación



P.652
Techo



P.678 Calefacción



P.679
Calefactores



P.685
Estufas
y braseros



P.691
Radiadores y
emisores térm.



P.694
Convectores



P.697
Calefactores
pared



P.698
Exterior



P.701
Industrial

PAE



P.702 Cocina



P.703
Exprimidores



P.704
Batidoras



P.708
Cafeteras



P.712
Hervidores



P.714
Tostadoras



P.719
Sandwicheras



P.722
Freidoras



P.724
Hornos
y microondas



P.729
Placas
y hornillos



P.733
Vinoteca



P.734
Básculas



P.737 Cuidado personal



P.738
Básculas



P.740
Secadores



P.743
Afeitadoras
y cortapelos



P.745 Hogar y bienestar



P.746
Planchado



P.749
Equipos de
limpieza



P.752
Soluciones
térmicas

Menaje



P.759 Equipamiento de cocina



P.760
Sartenes
y paelleras



P.766
Baterías



P.768
Gas butano
y barbacoas



P.774 Instrumentos de cocina



P.775
Cocinado



P.779
Corte, picado,
rallado



P.785
Abridores



P.787
Accesorios
vino



P.791
Bebidas
y líquidos



P.795
Porta
alimentos



P.799
Pesar y medir



P.801 Instrumentos de mesa



P.802
Vajilla



P.804
Sujeta-
manteles



P.805 Ordenación y recipientes



P.806
Tápers



P.809
Contenedores
reciclaje aceite



P.810
Botes cocina



P.810
Escurridores



P.811
Organizadores



P.813
Limpieza

Ferretería



P.814 Hogar



P.815
Relojes



P.818
Radios
y calculadoras



P.820
Lavado
y planchado



P.828
Tijeras



P.829
Barreños



P.829
Cubos basura
y reciclaje



P.833
Capazos
y cubos



P.834
Bayetas y cu-
bos limpieza



P.835
Escobas,
recogedores



P.838
Desatascado-
res



P.840
Baño



P.843 Jardín y terraza



P.844
Mosquiteros



P.850
Riego



P.861
Herramientas



P.868
Macetas



P.870
Termómetros



P.871
Mobiliario



P.872 Fontanería



P.873
Equipamiento
ducha



P.877
Mecanismos



P.879
Sifones
y válvulas



P.889
Grifería



P.893 Herrajes y accesorios muebles



P.894
Soportes
y topos



P.902
Filtros



P.905
Burlletes



P.909
Gotas
adhesivas



P.910
Protección
niños/as

Navidad y decoración



P.916 Herramientas y bricolaje



P.917
Herramientas manuales



P.953
Herramientas eléctricas



P.964
Consumibles y abrasivos



P.976
Automóvil



P.977
Sujeción y almacenaje



P.984
Letras y símbolos



P.988
Escaleras y taburetes



P.991
Carros de transporte



P.993
Cinta adhesiva



P.998 Artículos de navidad



P.999
Guirnaldas



P.1026
Ramas



P.1028
Gnomos



P.1031
Estrellas



P.1032
Cortinas



P.1035
Tubos LED



P.1040
Árboles



P.1047
Muñecos exterior



P.1048 Velas decorativas



Primeras marcas



P.1052 Pilas y baterías



P.1053
GSC



P.1057
Philips



P.1059
Maxell



P.1060
GP



P.1061
Duracell



P.1066
Procell

Expositores



P.1067 Expositores comerciales



P.1068
Sobremesa y pie

Área técnica



P.1071 Información técnica



Bases múltiples

Material eléctrico



Estándar

SERIE



x2 x3 x4 x5 x6 x4
 1.5M 3M 1.5M 3M 1.5M 3M 1.5M 3M 1.5M 3M 1.5M
 5M

CHILD **A** 16A 250V **Hz** 50Hz

Bases múltiples

Cable eléctrico H05VV-F para enchufe 2P+TT lateral. Con protección para niños/as.

Referencia	Potencia	Tomas	Sección	Longitud	Embalaje
100005009 ★	Máx. 3680W	2	(3x1.5mm)	1.5M	15
100005019 ★	Máx. 3680W	2	(3x1.5mm)	3M	20
000000000	Máx. 3680W	3	(3x1.0mm)	1.5M	20
000000008	Máx. 3680W	3	(3x1.5mm)	1.5M	20
000000016	Máx. 3680W	3	(3x1.5mm)	3M	20
000001060	Máx. 3680W	3	(3x1.5mm)	5M	20
000000002	Máx. 3680W	4	(3x1.0mm)	1.5M	15
000000010	Máx. 3680W	4	(3x1.5mm)	1.5M	15
000000018	Máx. 3680W	4	(3x1.5mm)	3M	15
000000004	Máx. 3680W	5	(3x1.0mm)	1.5M	15
000000012	Máx. 3680W	5	(3x1.5mm)	1.5M	15
000000020	Máx. 3680W	5	(3x1.5mm)	3M	15
000000006	Máx. 3680W	6	(3x1.0mm)	1.5M	15
000000014	Máx. 3680W	6	(3x1.5mm)	1.5M	15
000000022	Máx. 3680W	6	(3x1.5mm)	3M	15
100005021 ★	Máx. 3680W	4	(3x1.5mm)	1.5M	20





Estándar SERIE



CHILD



16A



250V



50Hz

Bases múltiples con interruptor

Cable eléctrico H05VV-F para enchufe 2P+TT lateral. Con protección para niños/as.

Referencia	Potencia	Tomos	Sección	Longitud	Embalaje
100005010 ★	Máx. 3680W	2	(3x1.5mm)	1.5M	15
100005020 ★	Máx. 3680W	2	(3x1.5mm)	3M	20
000000001	Máx. 3680W	3	(3x1.0mm)	1.5M	20
000000009	Máx. 3680W	3	(3x1.5mm)	1.5M	20
000000017	Máx. 3680W	3	(3x1.5mm)	3M	20
000000793	Máx. 3680W	3	(3x1.5mm)	5M	20
000000003	Máx. 3680W	4	(3x1.0mm)	1.5M	15
000000011	Máx. 3680W	4	(3x1.5mm)	1.5M	15
000000019	Máx. 3680W	4	(3x1.5mm)	3M	15
000000794	Máx. 3680W	4	(3x1.5mm)	5M	15
000000005	Máx. 3680W	5	(3x1.0mm)	1.5M	15
000000013	Máx. 3680W	5	(3x1.5mm)	1.5M	15
000000021	Máx. 3680W	5	(3x1.5mm)	3M	15
000000795	Máx. 3680W	5	(3x1.5mm)	5M	15
000000007	Máx. 3680W	6	(3x1.0mm)	1.5M	15
000000015	Máx. 3680W	6	(3x1.5mm)	1.5M	15
000000023	Máx. 3680W	6	(3x1.5mm)	3M	15
000000796	Máx. 3680W	6	(3x1.5mm)	5M	10

Estándar

SERIE



Bases múltiples Interior

Bases múltiples

 CHILD
  16A
  250V
  50Hz

Cable eléctrico H05VV-F para enchufe 2P+TT lateral. Con protección para niños/as.

Referencia	Potencia	Tomas	Sección	Longitud	Embalaje
000000024	Máx. 3680W	3	(3x1.5mm)	1.5M	20
100005011 ★	Máx. 3680W	3	(3x1.5mm)	3M	20
000000026	Máx. 3680W	4	(3x1.5mm)	1.5M	15
100005013 ★	Máx. 3680W	4	(3x1.5mm)	3M	15
000000028	Máx. 3680W	5	(3x1.5mm)	1.5M	15
000000030	Máx. 3680W	6	(3x1.5mm)	1.5M	15



Estándar

SERIE



Bases múltiples con interruptor

CHILD
 16A
 250V
 50Hz

Cable eléctrico H05VV-F para enchufe 2P+TT lateral. Con protección para niños/as.

Referencia	Potencia	Tomas	Sección	Longitud	Embalaje
000000025	Máx. 3680W	3	(3x1.5mm)	1.5M	20
100005012 ★	Máx. 3680W	3	(3x1.5mm)	3M	20
000000027	Máx. 3680W	4	(3x1.5mm)	1.5M	15
100005014 ★	Máx. 3680W	4	(3x1.5mm)	3M	15
000000029	Máx. 3680W	5	(3x1.5mm)	1.5M	15
000000031	Máx. 3680W	6	(3x1.5mm)	1.5M	15

Mega

SERIE

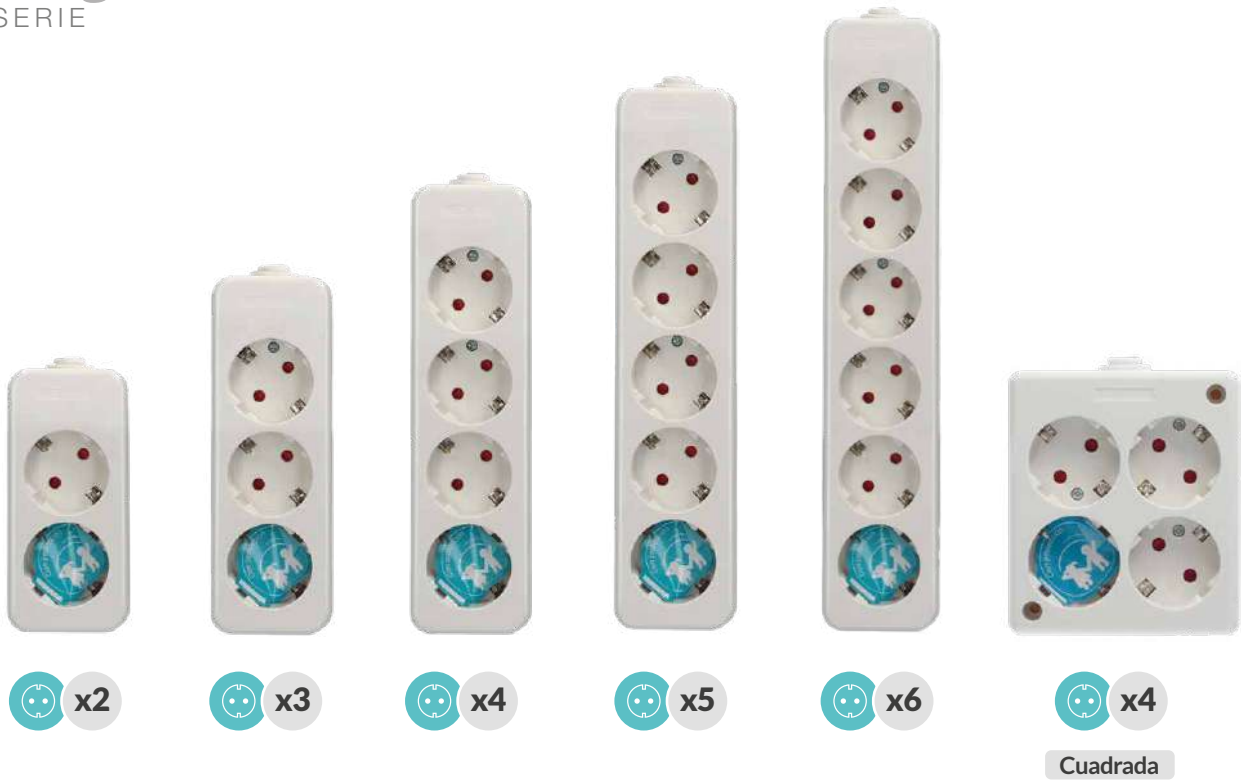

Bases múltiples Interior

Bases múltiples sin cable



Sin cable eléctrico. Material: **PC**. Con protección para niños/as. **Bolsa**.

Referencia	Potencia	Tomas	Embalaje
000800222	Máx. 3680W	2	10/50
000800223	Máx. 3680W	3	10/50
000800225	Máx. 3680W	4	10/50
000800227	Máx. 3680W	5	10/50
000800229	Máx. 3680W	6	10/50

Bases múltiples sin cable **cuadrada**



Sin cable eléctrico. Material: **PC**. Con protección para niños/as. **Bolsa**.

Referencia	Potencia	Tomas	Embalaje
000800231	Máx. 3680W	4	10/50



Mega

SERIE

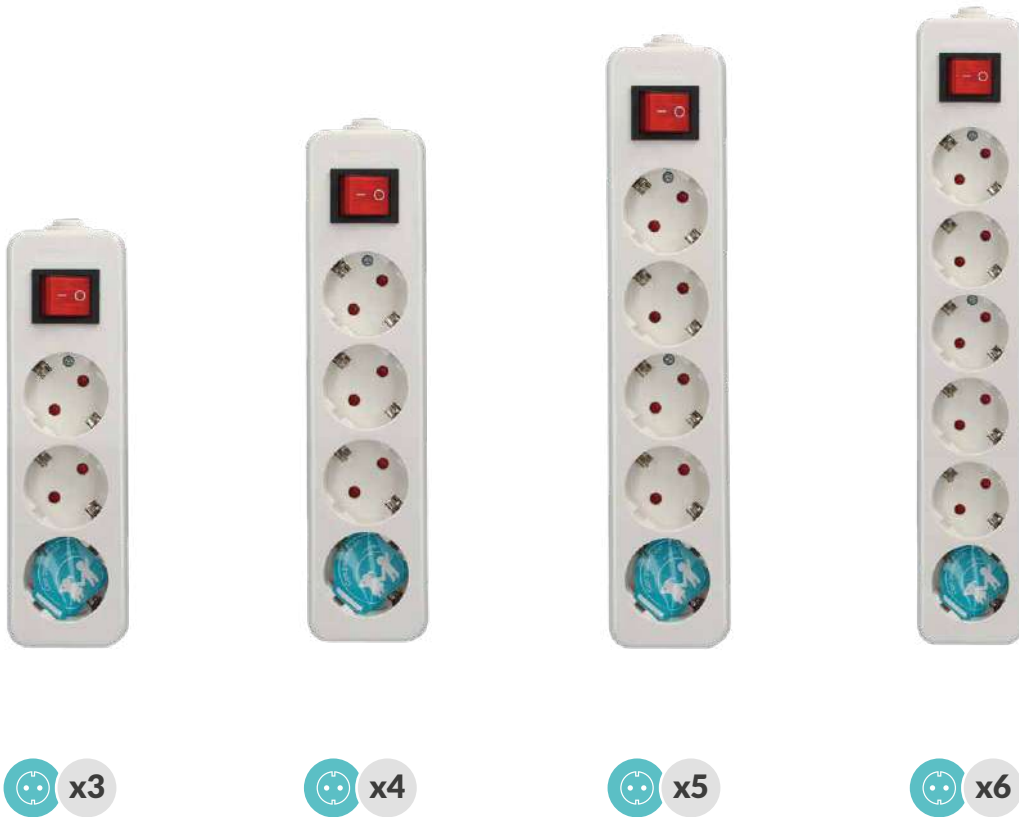

Bases múltiples sin cable con interruptor



Sin cable eléctrico. Material: **PC**. Con protección para niños/as. **Bolsa**.

Referencia	Potencia	Tomas	Embalaje
000800276	Máx. 3680W	3	10/50
000800226	Máx. 3680W	4	10/50
000800228	Máx. 3680W	5	10/50
000800230	Máx. 3680W	6	10/50

Mega

SERIE



 x2
1.5M

 x3
1.5M

 x4
1.5M

 x5
1.5M

 x6
1.5M

Bases múltiples Interior

Bases múltiples con cable

 CHILD  16A  250V  50Hz

Cable eléctrico H05VV-F para enchufe 2P+TT lateral. Material: **PC**. Con protección para niños/as. **Blíster**.

Referencia	Potencia	Tomas	Sección	Longitud	Embalaje
000800275	Máx. 3680W	2	(3x1.5mm)	1.5M	24
000800058	Máx. 3680W	3	(3x1.5mm)	1.5M	24
000800212	Máx. 3680W	4	(3x1.5mm)	1.5M	24
000800214	Máx. 3680W	5	(3x1.5mm)	1.5M	24
000800216	Máx. 3680W	6	(3x1.5mm)	1.5M	24



Mega

SERIE



 x2
1.5M

 x3
1.5M 3M

 x4
1.5M 3M

 x5
1.5M 3M

 x6
1.5M 3M

Bases múltiples con cable + interruptor

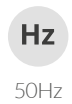

Cable eléctrico H05VV-F para enchufe 2P+TT lateral. Material: **PC**. Con protección para niños/as. **Blíster**.

Referencia	Potencia	Tomas	Sección	Longitud	Embalaje
000800792	Máx. 3680W	2	(3x1.5mm)	1.5M	24
000800211	Máx. 3680W	3	(3x1.5mm)	1.5M	24
000800874	Máx. 3680W	3	(3x1.5mm)	3M	12
000800213	Máx. 3680W	4	(3x1.5mm)	1.5M	24
000800875	Máx. 3680W	4	(3x1.5mm)	3M	12
000800215	Máx. 3680W	5	(3x1.5mm)	1.5M	24
000800876	Máx. 3680W	5	(3x1.5mm)	3M	12
000800217	Máx. 3680W	6	(3x1.5mm)	1.5M	24
000800877	Máx. 3680W	6	(3x1.5mm)	3M	12

USB
BASES



Bases múltiples con interruptor + 2 USB

CHILD
 16A
 220-240V
 50Hz

Cable eléctrico H05VV-F para enchufe 2P+TT lateral.

Referencia	Potencia	Tomas	Sección	Salida total USB	Longitud	Embalaje
100000000	Máx. 3680W	3	(3x1.5mm)	2.1A/5V	1.4M	20
100000001	Máx. 3680W	6	(3x1.5mm)	2.1A/5V	1.4M	20
100000004★	Máx. 3680W	3	(3x1.5mm)	3A/5V	1.4M	20
100000005★	Máx. 3680W	5	(3x1.5mm)	3A/5V	1.4M	20
100000006★	Máx. 3680W	6	(3x1.5mm)	3A/5V	1.4M	20





Especiales

BASES



 x3



 x8



Bases múltiples con interruptor + 2 USB



CHILD



10/16A



250V



50Hz

Cable eléctrico H05VV-F para enchufe 2P+TT lateral.

Salida total USB: 2.1A.

Referencia	Potencia	Tomas	Sección	Longitud	Protección subidas tensión	Protección sobrecalentamiento	Embalaje
000803392	Máx. 3680W	3	(3x1.5mm)	1.4M	No	No	20
000803393	Máx. 3680W	8	(3x1.5mm)	1.4M	Sí	Sí	10

Especiales

BASES



x4

x6

x8

x9

x12

Bases múltiples Interior

Bases múltiples con interruptor



CHILD

A

10/16A



250V

Hz

50Hz

Cable eléctrico H05VV-F para enchufe 2P+TT lateral.

Referencia	Potencia	Tomas	Sección	Longitud	Protección subidas tensión	Protección sobrecalentamiento	Embalaje
000800090	Máx. 3500W	4	(3x1.5mm)	1.5M	Sí	Sí	20
000800797	Máx. 3500W	6	(3x1.5mm)	1.5M	Sí	Sí	20
000800798	Máx. 3500W	8	(3x1.5mm)	1.5M	Sí	Sí	20
000800064	Máx. 3500W	9	(3x1.5mm)	1.5M	No	Sí	20
000803313	Máx. 3680W	12	(3x1.5mm)	1.5M	No	No	10



Aluminio

SERIE



x3



x4



x5



x6

Bases múltiples aluminio con interruptor



CHILD



10/16A



250V



50Hz

Cable eléctrico H05VV-F para enchufe 2P+TT lateral. Material: **Aluminio**. Con protección para niños/as. Protección para **subidas de tensión** y **sobrecalentamiento**.

Referencia	Potencia	Tomas	Sección	Longitud	Embalaje
000801084	Máx. 3680W	3	(3x1.5mm)	1.5M	20
000801085	Máx. 3680W	4	(3x1.5mm)	1.5M	20
000801086	Máx. 3680W	5	(3x1.5mm)	1.5M	20
000801087	Máx. 3680W	6	(3x1.5mm)	1.5M	20

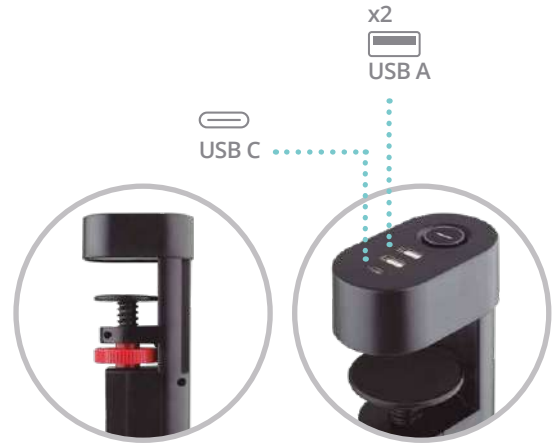

Base múltiple sobremesa 2 USB A + 1 USB C



CHILD



16A



220-240V



50Hz

Pinza regulable. Cable eléctrico H05VV-F para enchufe 2P+TT lateral.
Material: PC. Botón On/Off. Con protección para niños/as.

Velocidad de carga (Output USB A): 5V / 3.0A / Máx.15W.

Velocidad de carga (Output USB C): 5V / 3.0A / Máx.15W.

Velocidad de carga (Output USB A + C): 5V / 3.4A / Máx.17W (En total).

Velocidad de carga (Output USB A + A + C): 5V / 3.4A / Máx.17W (En total).

Referencia	Potencia	Tomas	Sección	Longitud	Embalaje
100000003	Máx. 3680W	3	(3x1.5mm)	1.4M	12

Multi

INTERRUPTOR



Bases múltiples Interior

Bases múltiples multi interruptor



CHILD

A

16A



250V

Hz

50Hz

Con interruptor **individual** y **general**. Cable eléctrico H05VV-F para enchufe 2P+TT lateral.
Material: **PC**. Con protección para niños/as. Protección para **subidas de tensión**. Blíster.

Referencia	Potencia	Tomas	Sección	Longitud	Embalaje
100010002	Máx. 3680W	3	(3x1.5mm)	1.5M	20
100010003	Máx. 3680W	4	(3x1.5mm)	1.5M	20
100010004	Máx. 3680W	5	(3x1.5mm)	1.5M	20
100010005	Máx. 3680W	6	(3x1.5mm)	1.5M	20

BASES CON

Protección



Bases múltiples Interior

Bases múltiples con protección



CHILD



16A



250V



50Hz

Cable eléctrico H05VV-F para enchufe 2P+TT lateral.

Material: **PC**. Con protección para niños/as. Protección para **subidas de tensión**.

Referencia	Potencia	Tomas	Sección	Longitud	Embalaje
100005015	Máx. 3680W	3	(3x1.5mm)	1.5M	20
100005016	Máx. 3680W	4	(3x1.5mm)	1.5M	20
100005017	Máx. 3680W	5	(3x1.5mm)	1.5M	20
100005018	Máx. 3680W	6	(3x1.5mm)	1.5M	20



Base doble sucko con tapas



CHILD



IP44



16A



250V



50Hz

Con tapas para engarzar cable.
Sucko 2P+TT lateral. Material: **goma**. Uso externo.

Referencia	Potencia	Tomas	Embalaje
000503302	Máx. 3680W	2	20



Ladrón doble sucko con tapas



CHILD



IP44



16A



250V



50Hz

Con tapas para engarzar cable.
Sucko 2P+TT lateral. Material: **goma**. Uso externo.

Referencia	Potencia	Tomas	Embalaje
000503303	Máx. 3680W	2	20





Base triple sucko sin cable con tapas



CHILD



IP44



16A



250V



50Hz

Con tapas para engarzar cable. Sucko 2P+TT lateral. Material: **goma**. Uso externo.

Referencia	Potencia	Tomas	Embalaje
000500168	Máx. 3680W	3	50



CHILD



IP44



16A



250V



50/60Hz

Base múltiple industrial 5 tomas

Con tapas para engarzar cable. Cable eléctrico **H07RN-F**. Sucko 2P+TT lateral. Material: **goma**. Uso externo.

Referencia	Potencia	Tomas	Sección	Longitud	Embalaje
000500118	Máx. 3500W	5	(3x1.5mm)	3M	20



A 
16A 250V

Base múltiple 4 tomas

Con **tapas**. Con cable eléctrico **H05RR-F de neopreno** para enchufe 2P+TT lateral.
Uso externo: **IP44**. Con protección para niños/as.

Referencia	Potencia	Sección	Longitud	Embalaje
100030001	Máx. 3680W	(3x1.5mm)	1.5M	15



A 
16A 250V

Base múltiple 4 tomas + interruptor

Con **tapas + interruptor**. Con cable eléctrico **H07RN-F de neopreno** para enchufe 2P+TT lateral.
Uso externo: **IP44**. Con protección para niños/as.

Referencia	Potencia	Sección	Longitud	Embalaje
000500169	Máx. 3680W	(3x1.5mm)	1.5M	30



A 
16A 250V

Estaca jardín **double sucko**

Con cable eléctrico **de goma H05RR-F** para enchufe 2P+TT lateral.
Uso externo: **IP44**. Con protección para niños/as.

Referencia	Potencia	Sección	Longitud	Embalaje
000501332	Máx. 3680W	(3x1.5mm)	1.5M	12



Alargadores de enchufes

Material eléctrico





Prolongador blanco



CHILD



2.5A



250V



50Hz

Cable redondo eléctrico H03VVH2-F para enchufe 2P. Con protección para niños/as.

Referencia	Potencia	Color	Sección	Longitud	Embalaje
100500000	Máx. 625W	○ Blanco	(2x0.75mm)	2M	20
100500001	Máx. 625W	○ Blanco	(2x0.75mm)	3M	20
100500002	Máx. 625W	○ Blanco	(2x0.75mm)	5M	20



Prolongador negro



CHILD



2.5A



250V



50Hz

Cable redondo eléctrico H03VVH2-F para enchufe 2P. Con protección para niños/as.

Referencia	Potencia	Color	Sección	Longitud	Embalaje
100500003	Máx. 625W	● Negro	(2x0.75mm)	2M	20
100500004	Máx. 625W	● Negro	(2x0.75mm)	3M	20



○ Blanco

2M 3M 4M
5M 10M



● Negro

2M 3M 4M 5M
10M 15M 25M



● Rojo

10M 15M 25M



CHILD



10/16A



250V



50Hz

Prolongadores

Cable redondo eléctrico H05VV-F para enchufe 2P+TT lateral. Con protección para niños/as.

Referencia	Potencia	Color	Sección	Longitud	Embalaje
000100040	Máx. 3680W	○ Blanco	(3x1.5mm)	2M	15
000100041	Máx. 3680W	○ Blanco	(3x1.5mm)	3M	15
000100042	Máx. 3680W	○ Blanco	(3x1.5mm)	4M	15
000100043	Máx. 3680W	○ Blanco	(3x1.5mm)	5M	15
000100044	Máx. 3680W	○ Blanco	(3x1.5mm)	10M	10
000100045	Máx. 3680W	● Negro	(3x1.5mm)	2M	20
000100046	Máx. 3680W	● Negro	(3x1.5mm)	3M	50
000100047	Máx. 3680W	● Negro	(3x1.5mm)	4M	20
000100048	Máx. 3680W	● Negro	(3x1.5mm)	5M	25
000100049	Máx. 3680W	● Negro	(3x1.5mm)	10M	20
000100050	Máx. 3680W	● Negro	(3x1.5mm)	15M	5
000100051	Máx. 3680W	● Negro	(3x1.5mm)	25M	5
000100052	Máx. 3680W	● Rojo	(3x1.5mm)	10M	20
000100053	Máx. 3680W	● Rojo	(3x1.5mm)	15M	10
000100054	Máx. 3680W	● Rojo	(3x1.5mm)	25M	5



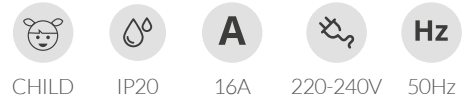
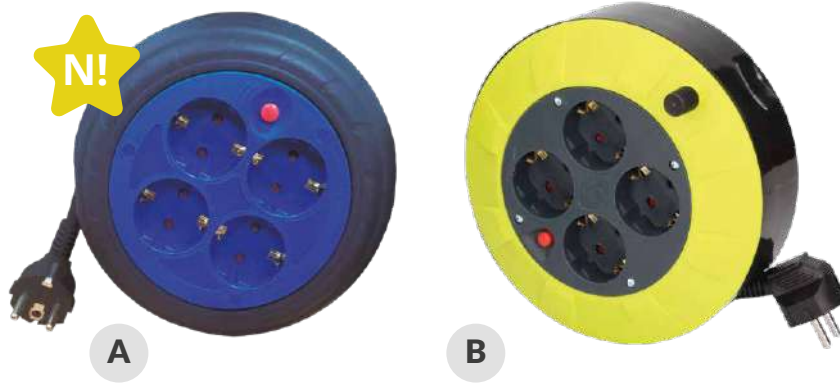

Enrollables alargador 4 enchufes

Con cable eléctrico H05VV-F, 2P+TT lateral.
Chasis de plástico y asa. Con **dispositivo de seguridad térmico y obturador**.

Referencia	Artículos	Potencia estirado	Potencia enrollado	Sección	Longitud	Embalaje
100510009 ★	A	Máx. 3200W / 16A	Máx. 1100W / 16A	(3x1.5mm)	3M	20
100510000	B	Máx. 3000W / 13A	Máx. 1000W / 4.3A	(3x1.5mm)	5M	10

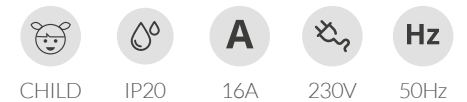

Enrollables alargador 4 enchufes

Con cable eléctrico H05VV-F, 2P+TT lateral.
Chasis de plástico y asa. Con **dispositivo de seguridad térmico y obturador**.

Referencia	Potencia estirado	Potencia enrollado	Sección	Longitud	Embalaje
100510001	Máx. 3000W / 13A	Máx. 1000W / 4.3A	(3x1.5mm)	10M	6
100510002	Máx. 3000W / 13A	Máx. 1000W / 4.3A	(3x1.5mm)	15M	6



Enrollacables alargador profesional 4 enchufes

Con cable eléctrico H05VV-F. 2P+TT lateral.
Carrete de plástico. **Soporte metálico** con maneta de PVC. Con **dispositivo de seguridad térmico y obturador**. IP20.

Referencia	Potencia estirado	Potencia enrollado	Sección	Longitud	Embalaje
100510008 ★	Máx. 3000W / 13A	Máx. 1000W / 4.3A	(3x1.5mm)	15M	4
100510003	Máx. 3000W / 13A	Máx. 1000W / 4.3A	(3x1.5mm)	25M	2
100510004	Máx. 3000W / 13A	Máx. 1000W / 4.3A	(3x1.5mm)	50M	1



Enrollacables alargador auto enrollable

Con cable eléctrico H05VV-F. 2P+TT lateral. Para **fijar en pared** con toma suco.
Carrete de plástico y soporte de pared de aluminio. Cable alimentación a red 230V.
Con **dispositivo de seguridad térmico y obturador**. IP20.

Referencia	Potencia estirado	Potencia enrollado	Sección	Longitud	Embalaje
000500879	Máx. 1800W	Máx. 1200W	(3x1.5mm)	11M + 2M	4



Matériel électrique française

Material eléctrico



Française
SÉRIE 



Multiprises de courant



CHILD



16A



250V



50Hz

Câble électrique H05VV-F pour brancher 2P+TT lateral. Avec protection enfant.

Référence	Puissance	Prises	Section	Longueur	Emballage
100025000	Máx. 3680W	3	(3x1.0mm)	1M	20
100025002	Máx. 3680W	4	(3x1.0mm)	1M	15
100025004	Máx. 3680W	5	(3x1.0mm)	1M	15
100025006	Máx. 3680W	6	(3x1.0mm)	1M	15

Française
SÉRIE 



 x3

 x4

 x5

 x6

Matériel électrique française Multiprises

Multiprises de courant avec interrupteur

 CHILD  **A** 16A  250V  **Hz** 50Hz

Câble électrique H05VV-F pour brancher 2P+TT lateral. Avec protection enfant.

Référence	Puissance	Prises	Section	Longueur	Emballage
100025001	Máx. 3680W	3	(3x1.0mm)	1M	20
100025003	Máx. 3680W	4	(3x1.0mm)	1M	15
100025005	Máx. 3680W	5	(3x1.0mm)	1M	15
100025007	Máx. 3680W	6	(3x1.0mm)	1M	15



Française

SÉRIE



Blanc

2M 3M 4M
5M 10M

Noir

2M 3M 4M 5M
10M 15M 25M



CHILD



10/16A



250V



50Hz

Rallonges électriques

Câble électrique H05VV-F pour brancher 2P+TT lateral. Avec protection enfant.

Référence	Puissance	Couleur	Section	Longueur	Emballage
007003708	Mâx. 3680W	○ Blanc	(3x1.5mm)	2M	20
007003709	Mâx. 3680W	○ Blanc	(3x1.5mm)	3M	20
007003710	Mâx. 3680W	○ Blanc	(3x1.5mm)	4M	50
007003711	Mâx. 3680W	○ Blanc	(3x1.5mm)	5M	15
007003712	Mâx. 3680W	○ Blanc	(3x1.5mm)	10M	15
007003713	Mâx. 3680W	● Noir	(3x1.5mm)	2M	50
007003714	Mâx. 3680W	● Noir	(3x1.5mm)	3M	50
007003715	Mâx. 3680W	● Noir	(3x1.5mm)	4M	50
007003716	Mâx. 3680W	● Noir	(3x1.5mm)	5M	25
007003717	Mâx. 3680W	● Noir	(3x1.5mm)	10M	20
007003718	Mâx. 3680W	● Noir	(3x1.5mm)	15M	10
007003719	Mâx. 3680W	● Noir	(3x1.5mm)	25M	8



Cables

Material eléctrico

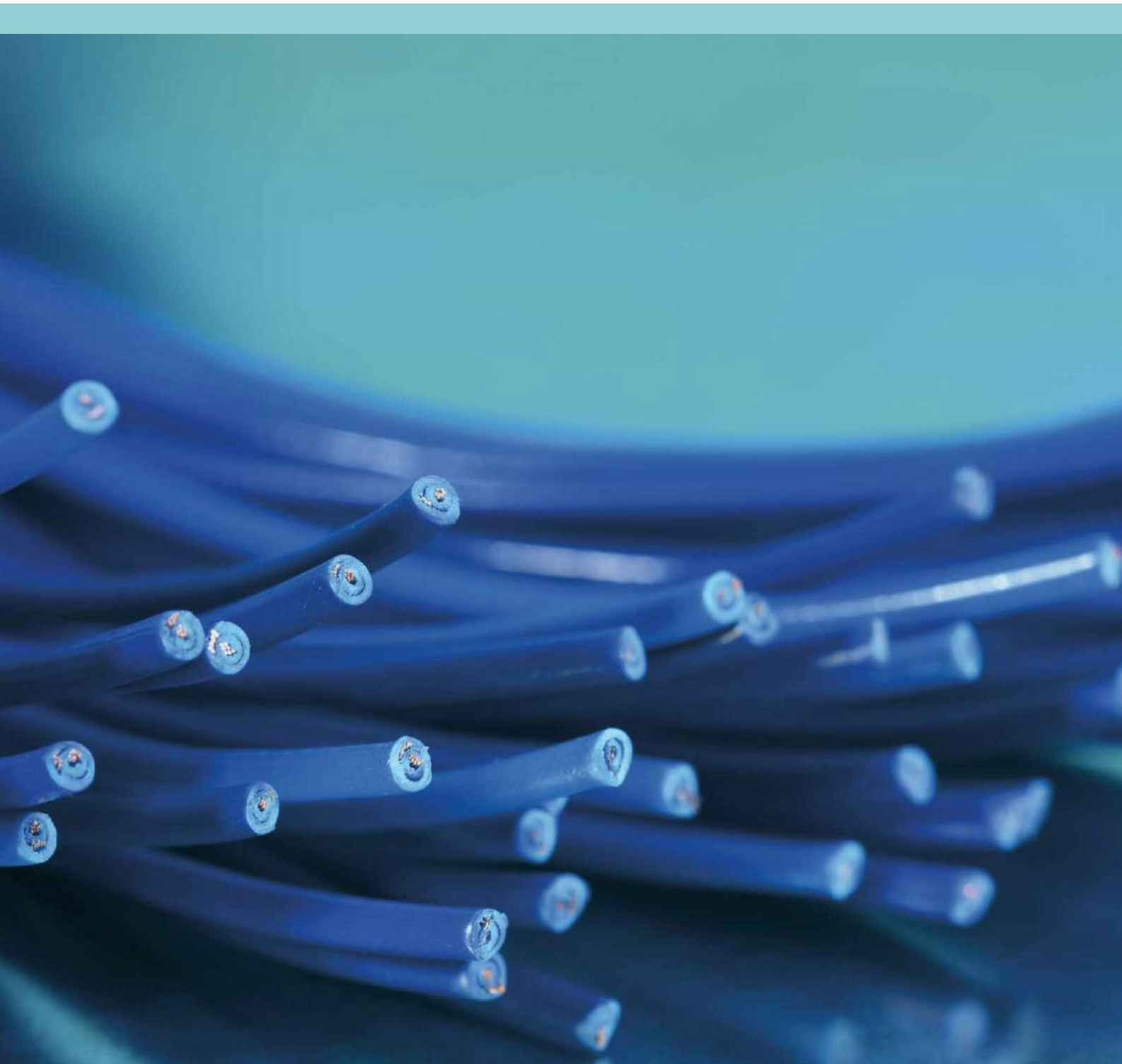



A



B

Rollo 100M cable paralelo audio PVC

Material conductor: **cobre**.

Referencia	Artículo	Sección	Color	Longitud	Embalaje
003902938	A	(2x0.5mm ²)	○ Blanco	100M	1
003902939	A	(2x0.75mm ²)	○ Blanco	100M	1
003902940	A	(2x1.0mm ²)	○ Blanco	100M	1
003902941	A	(2x1.5mm ²)	○ Blanco	100M	1
003902904	B	(2x0.75mm ²)	● Rojo/Negro	100M	1
003902905	B	(2x1.0mm ²)	● Rojo/Negro	100M	1
003902906	B	(2x1.5mm ²)	● Rojo/Negro	100M	1



Rollo 50M tubo flexible extraplano

Tipo: **H07V-K**. Aislamiento: **0.7KV**. Material conductor: **cobre**.

Suministro de electricidad en edificios y otras **obras de ingeniería civil** con el objeto de limitar la generación y propagación de fuego y humo.

CPR Clasificación reacción al fuego: **Cca - s1b,d1,a1**.

Referencia	Sección	Color	Longitud	Embalaje
003902952	(3x1.5mm ²)	○ Blanco	50M	1

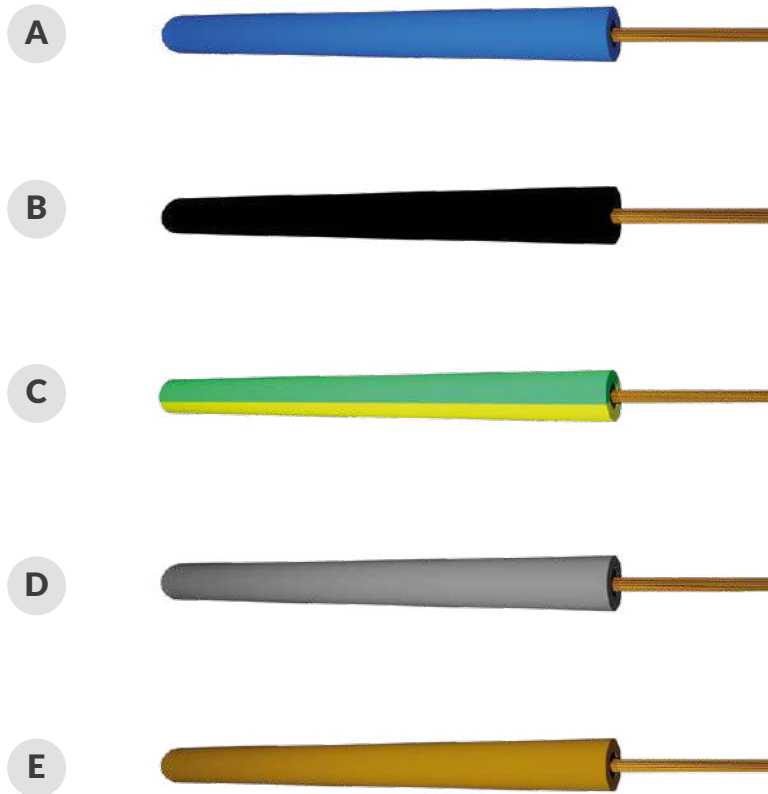

Rollo 100M cable flexible libre halógeno

Tipo: **H07Z1-K**. Aislamiento: **0.7KV**. Material conductor: **cobre**.

Suministro de electricidad en edificios y otras **obras de ingeniería civil** con el objeto de limitar la generación y propagación de fuego y humo.

CPR Clasificación reacción al fuego: **Cca - s1b,d1,a1**.

Referencia	Artículo	Sección	Color	Longitud	Embalaje
003902942	A	(1x1.5mm ²)	● Azul	100M	1
003902947	A	(1x2.5mm ²)	● Azul	100M	1
003902943	B	(1x1.5mm ²)	● Negro	100M	1
003902948	B	(1x2.5mm ²)	● Negro	100M	1
003902944	C	(1x1.5mm ²)	● Verde/Amarillo	100M	1
003902949	C	(1x2.5mm ²)	● Verde/Amarillo	100M	1
003902945	D	(1x1.5mm ²)	● Gris	100M	1
003902950	D	(1x2.5mm ²)	● Gris	100M	1
003902946	E	(1x1.5mm ²)	● Marrón	100M	1
003902951	E	(1x2.5mm ²)	● Marrón	100M	1



Rollo 100M cable apantallado libre halógeno

Tipo: **H07Z1-K**. Material conductor: **cobre**. Cables sistemas contra **incendios**, sistemas de **seguridad** (alarmas), **intercomunicación** (telefonía, porteros automáticos) y sonido. Suministro de electricidad en edificios y otras obras de ingeniería civil con el objeto de limitar la generación y propagación de fuego y humo. **CPR** Clasificación reacción al fuego: **Cca - s1b,d1,a1**. Llevan 2 cables rojo-negro de 0.70mm² para la alimentación y los otros para el conexionado de los equipos 0.20mm².

Referencia	Nº Conductores	Aislamiento	Exterior aproximado	Longitud	Embalaje
003902953	4	0.7KV	Ø4mm	100M	1
003902954	6	0.7KV	Ø4.8mm	100M	1
003902955	8	0.7KV	Ø5.1mm	100M	1
003902956	2+4	0.7KV	Ø5.6mm	100M	1
003902957	2+6	0.7KV	Ø6mm	100M	1

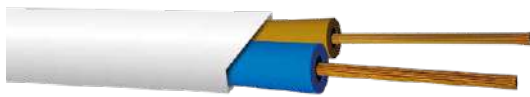

A



B

Rollo 100M manguera plana

Material conductor: **cobre**.

Referencia	Artículo	Sección	Aislamiento	Color	Longitud	Embalaje
003902919	A	(2x0.75mm ²)	0.3KV	○ Blanco	100M	1
003902920	A	(2x1.0mm ²)	0.3KV	○ Blanco	100M	1
003902921	A	(2x1.5mm ²)	0.3KV	○ Blanco	100M	1
003902935	B	(2x0.75mm ²)	0.3KV	● Negro	100M	1
003902936	B	(2x1.0mm ²)	0.3KV	● Negro	100M	1
003902937	B	(2x1.5mm ²)	0.3KV	● Negro	100M	1



50M

100M

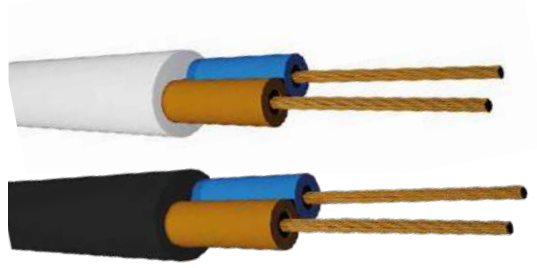

A

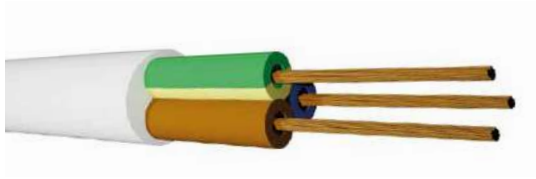

B



C

Rollo manguera blanca

Material conductor: **cobre**. Cables sujetos a requisitos de reacción al fuego para aplicaciones generales en obras de construcción.
CPR Clasificación reacción al fuego: **ECA**. Cable: **VV-F**.

Referencia	Artículo	Sección	Aislamiento	Color	Longitud	Embalaje
003902922	A	(2x0.5mm ²)	0.5KV	○ Blanco	100M	1
003902923	A	(2x0.75mm ²)	0.5KV	○ Blanco	100M	1
101005005 ★	A	(2x1.0mm ²)	0.5KV	○ Blanco	50M	1
003902924	A	(2x1.0mm ²)	0.5KV	○ Blanco	100M	1
101005006 ★	A	(2x1.5mm ²)	0.5KV	○ Blanco	50M	1
003902925	A	(2x1.5mm ²)	0.5KV	○ Blanco	100M	1
101005001	A	(2x1.5mm ²)	0.5KV	● Negro	100M	1
003902926	A	(2x2.5mm ²)	0.5KV	○ Blanco	100M	1
003902927	B	(3x0.75mm ²)	0.5KV	○ Blanco	100M	1
101005008 ★	B	(3x1.0mm ²)	0.5KV	○ Blanco	50M	1
003902928	B	(3x1.0mm ²)	0.5KV	○ Blanco	100M	1
101005003 ★	B	(3x1.5mm ²)	0.5KV	○ Blanco	50M	1
003902929	B	(3x1.5mm ²)	0.5KV	○ Blanco	100M	1
101005009 ★	B	(3x2.5mm ²)	0.5KV	○ Blanco	50M	1
003902930	B	(3x2.5mm ²)	0.5KV	○ Blanco	100M	1
101005002	C	(4x1.5mm ²)	0.5KV	● Negro	100M	1





50M 100M

Rollo manguera flexible negra

Material conductor: **cobre**. Cables sujetos a requisitos de reacción al fuego para aplicaciones generales en obras de construcción.
CPR Clasificación reacción al fuego: **ECA**.

Referencia	Cable	Sección	Aislamiento	Color	Longitud	Embalaje
003902931	VV-F	(3x1.0mm ²)	0.5KV	● Negro	100M	1
101005004 ★	RV-K	(3x1.5mm ²)	0.6-1KV	● Negro	50M	1
003902932	RV-K	(3x1.5mm ²)	0.6-1KV	● Negro	100M	1
101005007 ★	RV-K	(3x2.5mm ²)	0.6-1KV	● Negro	50M	1
003902933	RV-K	(3x2.5mm ²)	0.6-1KV	● Negro	100M	1
003902934	RV-K	(4x2.5mm ²)	0.6-1KV	● Negro	100M	1



A



B



Cable solar

Tipo de cable: **solar**. Material conductor: **cobre**. Cables destinados para el uso en **instalaciones solares fotovoltaicas**, principalmente en la parte de la instalación de corriente continua. Cable adecuado para trabajar de forma permanente en el exterior, bajo condiciones climáticas variables y exigentes. **CPR** Clasificación reacción al fuego: **ECA**.

Referencia	Artículo	Cable	Sección	Diámetro exterior	Color	Longitud	Embalaje
101040001	A	H1Z2Z2-K	(1x4mm ²)	Ø5.6mm	● Negro	100M	1
101040002	B	H1Z2Z2-K	(1x4mm ²)	Ø5.6mm	● Rojo	100M	1
101040003	A	H1Z2Z2-K	(1x6mm ²)	Ø6.15mm	● Negro	100M	1





Rollo 100M cable coaxial aluminio

CARACTERÍSTICAS TÉCNICAS

			Atenuación (dB/100)		Atenuación (dB/100)	
Conductor central	Diámetro 1.02 ± 0.02mm	Material CCS	50MHz	4.80	1000MHz	20.90
Dieléctrico	Diámetro 4.80 ± 0.1mm	Material PE	200MHz	9.00	1250MHz	23.67
Lámina	Cobertura 100%	Material AL/PE	470MHz	14.03	1750MHz	28.50
Malla	Cobertura 47.2%	Material 16x4x0.12 AL	800MHz	18.65	2150MHz	32.05
Cubierta	Diámetro 7.00 ± 0.1mm	Material PVC	862MHz	19.42	2300MHz	33.33
Impedancia	75 ± 3Ω					
Velocidad propagación	82%					
Resistencia máx. conductor interno	110Ω/Km					
Resistencia máx. conductor externo	37Ω/Km					

Referencia	Tipo	Material	Longitud	Embalaje
002600941	3C2V	Aluminio RG6	100M	4

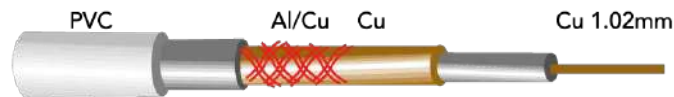

Rollo 100M cable coaxial cobre

CARACTERÍSTICAS TÉCNICAS

			Atenuación (dB/100)		Atenuación (dB/100)	
Conductor central	Diámetro 1.02 ± 0.016mm	Material Cobre	50MHz	4.50	1000MHz	20.51
Dieléctrico	Diámetro 4.57 ± 0.1mm	Material PE	200MHz	8.60	1250MHz	23.08
Lámina	Cobertura 100%	Material AL/PE/Cu	470MHz	13.55	1750MHz	27.30
Malla	Cobertura 46.3%	Material 16x4x0.12 Cu	800MHz	18.10	2300MHz	32.01
Cubierta	Diámetro 6.80 ± 0.1mm	Material PVC	862MHz	18.86		
Impedancia	75 ± 3Ω					
Velocidad propagación	82%					
Resistencia máx. conductor interno	22Ω/Km					
Resistencia máx. conductor externo	19Ω/Km					

Referencia	Tipo	Material	Longitud	Embalaje
002600942	3C2V	Cobre	100M	4



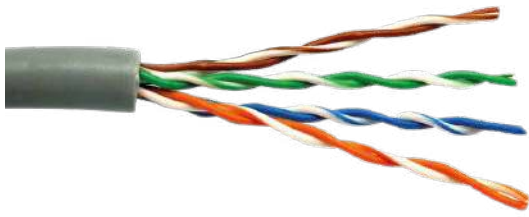

A

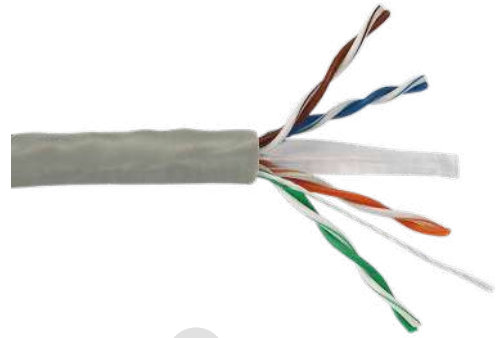

B

Rollo 100M cable de red UTP

Categoría: **CCA, UTP**. Cable CCA de **par trenzado** UTP 24AWG. Cable rígido ideal para instalaciones de cableado por regletas o similar. Revestimiento **LSZH libre de halógeno** y bajo nivel de humo para que no se propague la llama.

Referencia	Artículo	Sección	Categoría	Color	Longitud	Embalaje
003902626	A	(4x0.48mm)	CAT5e	● Gris	100M	4
003902628	B	(4x0.5mm)	CAT6	● Gris	100M	4
003902629	B	(4x0.5mm)	CAT6	● Gris	305M	2



Rollo 100M cable telefónico

Rollo cable telefónico plano.

Referencia	Conductores	Anchura	Color	Longitud	Embalaje
002600962	4	3.6mm	○ Blanco	100M	10



Guía pasacables 100% Nylon

Color: blanco.

Referencia	Longitud	Diámetro	Material	Embalaje
000600132	5M	Ø4mm	100% Nylon	150
000600133	10M	Ø4mm	100% Nylon	80
000600134	15M	Ø4mm	100% Nylon	60
000600135	20M	Ø4mm	100% Nylon	50



Guía pasacables fibra de vidrio

Color: naranja.

Referencia	Longitud	Diámetro	Material	Embalaje
000601065	5M	Ø4mm	Fibra vidrio + metal	25
000601066	10M	Ø4mm	Fibra vidrio + metal	20
000601067	15M	Ø4mm	Fibra vidrio + metal	15
000601068	20M	Ø4mm	Fibra vidrio + metal	14



Guía pasacables **trenzado**

Color: rojo y negro.

Referencia	Longitud	Diámetro	Material	Embalaje
501030001	30M	Ø6mm	Acero + PVC	20



Set 10 varillas pasacables **de fibra de vidrio**

Incluye: 10 varillas roscadas, 1 extensor flexible, 1 línea de ayuda para tirar, 1 extremo de gancho para tirar, 1 extremo de anillo para empujar, 2 tornillos de accesorios y 1 tubo de almacenamiento de plástico.

Referencia	Longitud	Nº varillas	Material	Embalaje
501030002	3.3M	10	Fibra vidrio	100



A



B



C



D



E



220-240V

Cable textil trenzado

Potencia: **máx. 60W**. Diámetro cable: Ø6mm. Cable: H03VV-F. Uso interior.

Referencia	Artículo	Longitud	Sección	Color	Embalaje
101025022	A	2.5M	(2x0.75mm)	● Negro	50
003902977	A	10M	(2x0.75mm)	● Negro	50
101025019	B	2.5M	(2x0.75mm)	● Gris oscuro	50
003902978	B	10M	(2x0.75mm)	● Gris oscuro	50
101025026 ★	C	2.5M	(2x0.75mm)	● Plateado	50
101025018	C	2.5M	(2x0.75mm)	● Gris claro	50
003902979	C	10M	(2x0.75mm)	● Gris claro	50
101025015	D	2.5M	(2x0.75mm)	● Cobre	50
003902980	D	10M	(2x0.75mm)	● Cobre	50
101025020	E	2.5M	(2x0.75mm)	● Marrón claro	50
003902981	E	10M	(2x0.75mm)	● Marrón claro	50



F



G



H



I



J



220-240V

Cable textil trenzado

Potencia: máx. 60W. Diámetro cable: Ø6mm. Cable: H03VV-F. Uso interior.

Referencia	Artículo	Longitud	Sección	Color	Embalaje
101025017	F	2.5M	(2x0.75mm)	● Dorado	50
003902982	F	10M	(2x0.75mm)	● Dorado	50
101025014	G	2.5M	(2x0.75mm)	● Amarillo	50
003902983	G	10M	(2x0.75mm)	● Amarillo	50
101025021	H	2.5M	(2x0.75mm)	● Naranja	50
003902984	H	10M	(2x0.75mm)	● Naranja	50
101025016	I	2.5M	(2x0.75mm)	● Cobrizo	50
003902985	I	10M	(2x0.75mm)	● Cobrizo	50
101025023	J	2.5M	(2x0.75mm)	● Negro/Blanco	50
003902986	J	10M	(2x0.75mm)	● Negro/Blanco	50



A **B** **C** **D** **E** **F** **G**



220-240V

Cable textil liso

Potencia: **máx. 60W**. Diámetro cable: Ø6mm. Cable: H03VV-F. Uso interior.

Referencia	Artículo	Longitud	Sección	Color	Embalaje
101025011	A	2.5M	(2x0.75mm)	● Negro/Gris	50
003902987	A	10M	(2x0.75mm)	● Negro/Gris	50
101025003	B	2.5M	(2x0.75mm)	● Rojo/Blanco	50
003902988	B	10M	(2x0.75mm)	● Rojo/Blanco	50
101025013	C	2.5M	(2x0.75mm)	● Rojo/Negro	50
003902989	C	10M	(2x0.75mm)	● Rojo/Negro	50
101025010	D	2.5M	(2x0.75mm)	● Negro/Blanco	50
003902990	D	10M	(2x0.75mm)	● Negro/Blanco	50
101025009	E	2.5M	(2x0.75mm)	● Negro	50
003902991	E	10M	(2x0.75mm)	● Negro	50
101025006	F	2.5M	(2x0.75mm)	● Gris claro	50
003902992	F	10M	(2x0.75mm)	● Gris claro	50
101025007	G	2.5M	(2x0.75mm)	● Marrón	50
003902993	G	10M	(2x0.75mm)	● Marrón	50



H



I



J



K



L



M



220-240V

Cable textil liso

Potencia: **máx. 60W**. Diámetro cable: Ø6mm. Cable: H03VV-F. Uso interior.

Referencia	Artículo	Longitud	Sección	Color	Embalaje
101025024	H	2.5M	(2x0.75mm)	● Bronce	50
101025001	H	10M	(2x0.75mm)	● Bronce	50
101025008	I	2.5M	(2x0.75mm)	● Marrón claro	50
003902994	I	10M	(2x0.75mm)	● Marrón claro	50
101025004	J	2.5M	(2x0.75mm)	● Champagne	50
003902995	J	10M	(2x0.75mm)	● Champagne	50
101025005	K	2.5M	(2x0.75mm)	● Dorado	50
003902996	K	10M	(2x0.75mm)	● Dorado	50
101025012	L	2.5M	(2x0.75mm)	● Plateado	50
003902997	L	10M	(2x0.75mm)	● Plateado	50
101025002	M	2.5M	(2x0.75mm)	○ Blanco	50
003902998	M	10M	(2x0.75mm)	○ Blanco	50





A

B



250V

Conexiones

Uso interior.

Referencia	Artículo	Tipo	Amperios	Sección	Longitud	Embalaje
001100234	A	Conexión AC/006	2.5A	(2x0.75mm)	1.5M	300
001100235	B	Conexión ordenador	10A	(3x0.75mm)	1.8M	50

Cables Alimentación y conexión

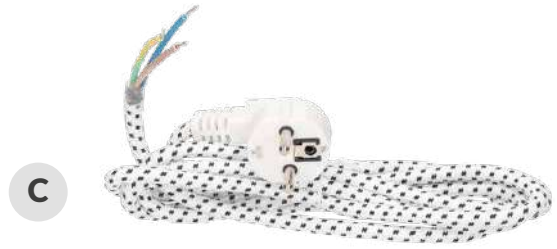

C



D



E

IP44

A

10/16A



250V

Conexiones

Puntas peladas en un extremo. Clavija sucko. Cable H05RN-F.

Referencia	Artículo	Tipo	Sección	Longitud	Embalaje
001100239	C	Conexión plancha	(3x1.0mm)	1.8M	50
001101091	D	Conexión cable PVC	(3x1.0mm)	1.5M	50
001101092	D	Conexión cable PVC	(3x1.0mm)	3M	50
001100154	E	Conexión neopreno	(3x1.0mm)	1.5M	50
001100155	E	Conexión neopreno	(3x1.0mm)	3M	50

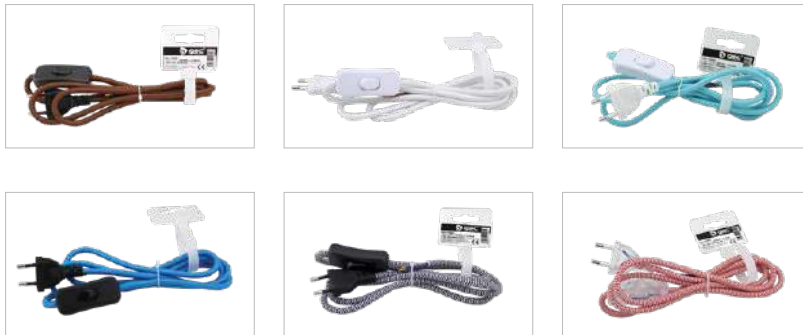

Cable textil con interruptor y clavija



220-240V

Longitud: **1.5M**. Uso interior.

Referencia	Sección	Color	Embalaje
001102958	(2x0.75mm)	● Plateado	50
001102959	(2x0.75mm)	● Dorado	50
001102960	(2x0.75mm)	● Marrón	50
001102961	(2x0.75mm)	○ Blanco	50
001102962	(2x0.75mm)	● Turquesa	50
001102963	(2x0.75mm)	● Azul	50
001102964	(2x0.75mm)	● Negro/Blanco	50
001102965	(2x0.75mm)	● Rojo/Blanco	50

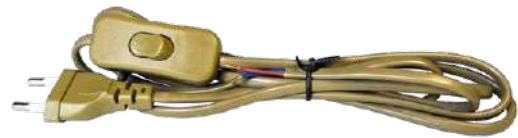

220-240V

Cable conexión plano

Con interruptor de paso. Longitud: **1.5M**. Uso interior.

Referencia	Sección	Color	Amperios	Embalaje
001100236	(2x0.75mm)	○ Blanco	2A	50
001100237	(2x0.75mm)	● Negro	2A	50
001102966	(2x0.75mm)	○ Transparente	2A	50
101020001	(2x0.75mm)	● Dorado	2A	50



Cajas y conexiones eléctricas

Material eléctrico

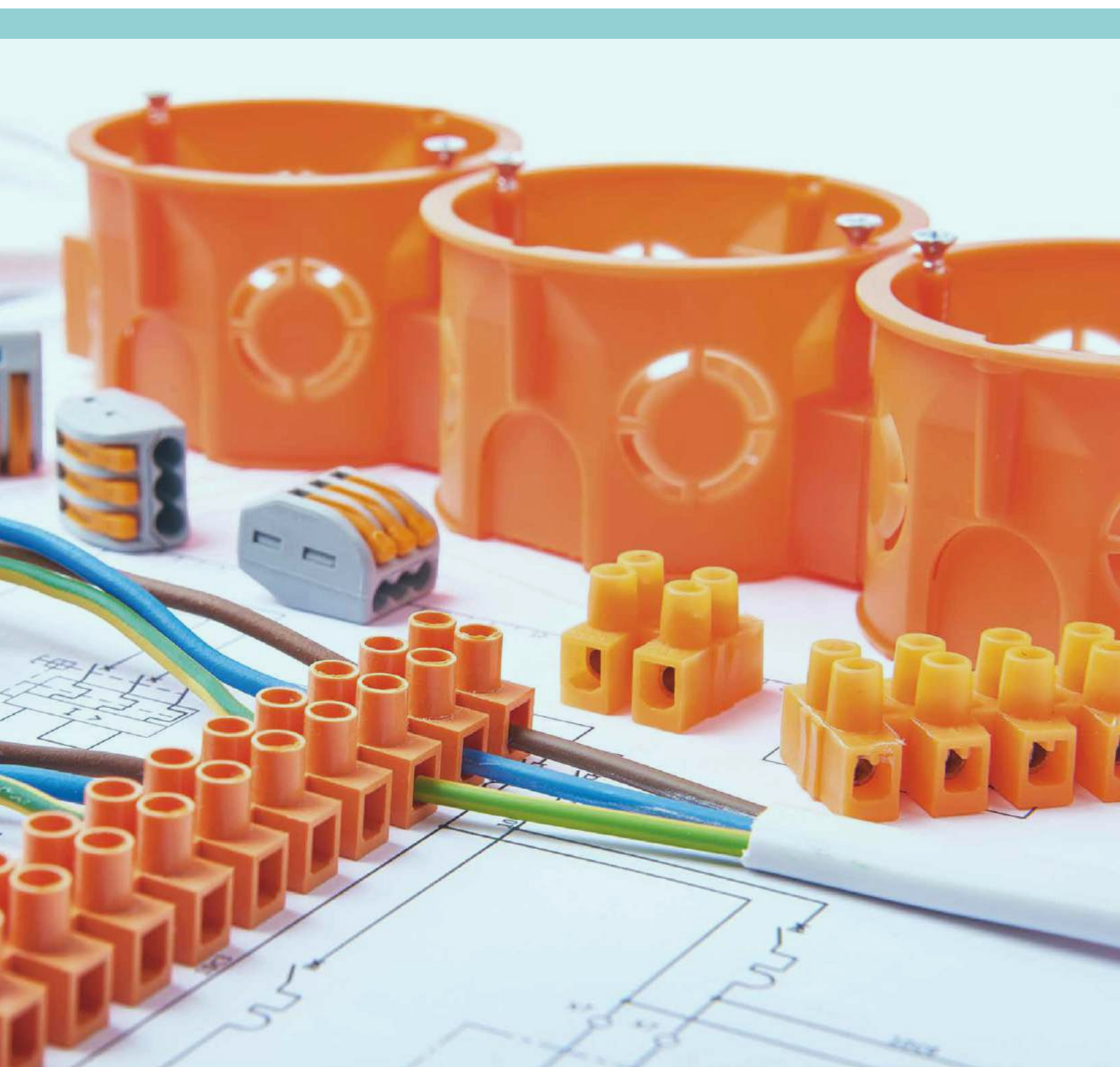



Petit

SERIE



A

2 vías

9.3x10x17.65mm



B

3 vías

9.3x13.2x17.65mm



C

5 vías

9.3x20.4x17.65mm



D

2 vías

14.5x12.4x20.5mm



E

3 vías

16.8x20.7x14.5mm



F

1 vía

9.5x20.8x15.8mm

Conectores empalme rápido



450V



50/60Hz

Bolsa 5 unidades.

Referencia	Artículo	Vías	Sección	Amperios	Color	Inflamabilidad	Embalaje
001105517	A	2	0.5-2.5mm ²	24A	● Rojo	UL 94V-0 T85 (IEC)	200/10000
001105518	B	3	0.5-2.5mm ²	24A	● Naranja	UL 94V-0 T85 (IEC)	200/10000
001105520	C	5	0.5-2.5mm ²	24A	● Gris	UL 94V-0 T85 (IEC)	100/4000
001105521	D	2	0.2-4mm ²	32A	● Naranja/Transp.	UL 94V-0 T85 (IEC)	100/5000
001105522	E	3	0.2-4mm ²	32A	● Naranja/Transp.	UL 94V-0 T85 (IEC)	100/5000
001105523	F	1	0.75-2.5mm ²	24A	● Gris	UL 94V-2 T110 (IEC)	100/5000



A

2 polos



B

3 polos

Terminales de conexión con doble pulsador



IP20



450V

Hz

50/60Hz

Nivel inflamabilidad V2. Bolsa 5 unidades.

Referencia	Artículo	Polos	Sección	Amperios	Material	Dimensión	Embalaje
001105524	A	2	0.5-2.5mm ²	16A	PC + PP	20x25.5x17mm	10/1000
001105525	B	3	0.5-2.5mm ²	16A	PC + PP	39.8x25.4x17.10mm	10/100



A



B

Regletas conexión cerámica

De **3 polos**. Pack 3 unidades.

Referencia	Artículo	Sección	Intensidad	Dimensión	Embalaje
001000727	A	6mm ²	10A	35x20x15mm	40/400
001000728	B	16mm ²	30A	50x25x20mm	16/160



Natural

Blanco

Negro

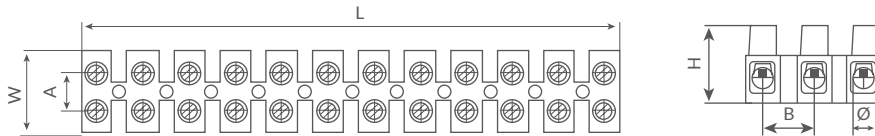

Regletas conexión

Bolsa 10 unidades. Voltaje: 250-450V. Voltaje nominal: 380V.

Referencia	Color	L(mm)	W(mm)	H(mm)	A(mm)	B(mm)	Ø(mm)	Para cable	Intensidad	Embalaje
001000102	● Natural	90.8	15.5	12.4	6	7.8	Ø3	2.5 - 4.0mm ²	3A	100
001000103	● Natural	111.4	15.5	13.5	6.5	9.6	Ø3.2	4.0 - 6.0mm ²	6A	100
001000104	● Natural	116.4	20	15.3	8	10	Ø4	6.0 - 10.0mm ²	10A	50
001000106	● Natural	162	25	19.3	12	13.9	Ø5.5	16mm ²	30A	30
001000107	● Natural	184.6	28.6	23	12	15.8	Ø6.8	25mm ²	60A	20
001000519	○ Blanco	90.8	15.5	12.4	6	7.8	Ø3	2.5 - 4.0mm ²	3A	100
001000520	○ Blanco	111.4	15.5	13.5	6.5	9.6	Ø3.2	4.0 - 6.0mm ²	6A	100
001000521	○ Blanco	116.4	20	15.3	8	10	Ø4	6.0 - 10.0mm ²	10A	50
001000522	○ Blanco	162	25	19.3	12	13.9	Ø5.5	16mm ²	30A	30
001000523	○ Blanco	184.6	28.6	23	12	15.8	Ø6.8	25mm ²	60A	20
001000108	● Negro	90.8	15.5	12.4	6	7.8	Ø3	2.5 - 4.0mm ²	3A	100
001000109	● Negro	111.4	15.5	13.5	6.5	9.6	Ø3.2	4.0 - 6.0mm ²	6A	100
001000110	● Negro	116.4	20	15.3	8	10	Ø4	6.0 - 10.0mm ²	10A	50
001000112	● Negro	162	25	19.3	12	13.9	Ø5.5	16mm ²	30A	30
001000113	● Negro	184.6	28.6	23	12	15.8	Ø6.8	25mm ²	60A	20



Horquillas

TERMINALES



A

5.7mm 6.4mm



B

6.0mm 8.1mm 9.5mm



C

8.3mm 9.0mm 12mm

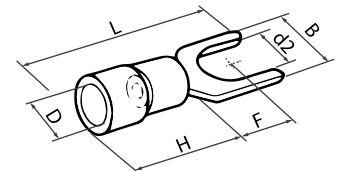

Terminales preaislados horquilla

Tipo: **redondo**. Dimensiones en mm.

Referencia	Artículo	Color	Sección	B	L	F	H	DØ	D2	Embalaje
000303600	A	● Rojo	1.5mm ²	5.7	21.2	6.5	10	4.3	3.2	30/360
000303601	A	● Rojo	1.5mm ²	6.4	21.2	6.5	10	4.3	4.3	30/360
000303603	B	● Azul	2.5mm ²	6.0	21.2	6.5	10	4.9	4.3	24/288
000303604	B	● Azul	2.5mm ²	8.1	21.2	6.5	10	4.9	5.3	24/288
000303605	B	● Azul	2.5mm ²	9.5	21.2	6.5	10	4.9	6.5	20/240
000303606	C	● Amarillo	4~6mm ²	8.3	25.2	7.5	12.5	6.7	4.3	10/120
000303607	C	● Amarillo	4~6mm ²	9.0	23.9	7.5	12.5	6.7	5.3	10/120
000303608	C	● Amarillo	4~6mm ²	12	31.2	12	12.5	6.7	6.5	10/120

Redondos

TERMINALES



A

5.7mm 6.6mm
8.0mm 11.6mm



B

6.6mm 9.5mm
12mm 13.6mm



C

9.5mm 9.5mm
12mm

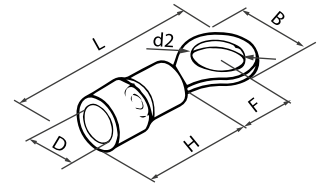

Terminales preaislados redondos

Tipo: **redondo**. Dimensiones en mm.

Referencia	Artículo	Color	Sección	B	L	F	H	DØ	D2	Embalaje
000303609	A	● Rojo	1.5mm ²	5.7	17.8	4.95	10	4.3	3.2	30/360
000303610	A	● Rojo	1.5mm ²	6.6	20.1	6.3	10	4.3	4.3	30/360
000303611	A	● Rojo	1.5mm ²	8.0	21.5	7.0	10	4.3	5.3	30/360
000303612	A	● Rojo	1.5mm ²	11.6	27.5	11.1	10	4.3	8.4	24/288
000303613	B	● Azul	2.5mm ²	6.6	21.0	7.0	10	4.9	4.3	30/360
000303614	B	● Azul	2.5mm ²	9.5	22.5	7.25	10	4.9	5.3	24/288
000303615	B	● Azul	2.5mm ²	12	27.6	11	10	4.9	6.5	20/240
000303616	B	● Azul	2.5mm ²	13.6	30.2	13.9	10	4.9	10.5	15/180
000303617	C	● Amarillo	4~6mm ²	9.5	25.5	8.3	12.5	6.7	4.3	10/120
000303618	C	● Amarillo	4~6mm ²	9.5	25.5	8.3	12.5	6.7	5.3	10/120
000303619	C	● Amarillo	4~6mm ²	12	31.5	13	12.5	6.7	6.5	10/120

Enchufables

HEMBRA



A

3.8mm 5.6mm 7.4mm



B

3.8mm 5.6mm 7.4mm



C

7.4mm

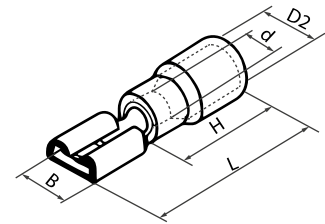

Enchufable preaislado hembra plano

Tipo: **hembra/enchufable**. Dimensiones en mm.

Referencia	Artículo	Color	Sección	B	L	H	DØ	D2	Embalaje
000303620	A	● Rojo	1.5mm ²	3.8	19	10	1.70	3.8	40/480
000303621	A	● Rojo	1.5mm ²	5.6	19	10	1.70	3.8	40/480
000303622	A	● Rojo	1.5mm ²	7.4	21	10	1.70	3.8	30/360
000303623	B	● Azul	2.5mm ²	3.8	19	10	2.3	4.3	30/360
000303624	B	● Azul	2.5mm ²	5.6	19	10	2.3	4.3	30/360
000303625	B	● Azul	2.5mm ²	7.4	21	10	2.3	4.3	24/288
000303626	C	● Amarillo	4-6mm ²	7.4	25	14	3.4	5.7	16/192





Enchufables

MACHO



A

2.8mm 4.75mm 6.35mm



B

4.75mm 6.35mm



C

6.35mm

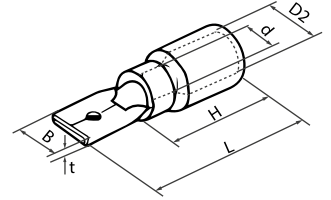

Enchufable preaislados macho plano

Tipo: macho/lengüeta. Dimensiones en mm.

Referencia	Artículo	Color	Sección	B	L	H	DØ	D2	Embalaje
000303627	A	● Rojo	1.5mm ²	2.8	17.7	10	1.70	4.3	40/480
000303628	A	● Rojo	1.5mm ²	4.75	20	10	1.70	4.3	40/480
000303629	A	● Rojo	1.5mm ²	6.35	21	10	1.70	4.3	30/480
000303630	B	● Azul	2.5mm ²	4.75	20	10	2.3	4.3	30/360
000303631	B	● Azul	2.5mm ²	6.35	21	10	2.3	4.3	30/360
000303632	C	● Amarillo	4~6mm ²	6.35	25	14	3.4	5.7	20/240

Manguitos

PREAISLADOS



A



B

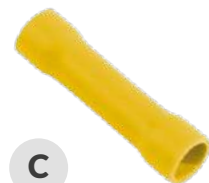

C

Manguitos preaislados

Tipo: preaislado.

Referencia	Artículo	Color	Dimensión	Embalaje
000303633	A	● Rojo	1.5mm	20/240
000303634	B	● Azul	2.5mm	16/192
000303635	C	● Amarillo	6mm	10/120

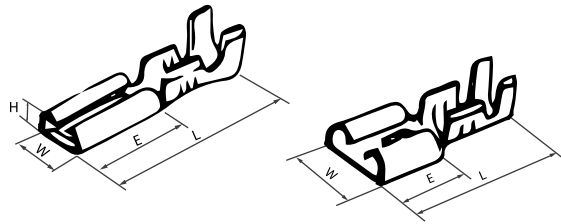

Terminales faston hembra

Tipo: **metálico**. Dimensiones en mm.

Referencia	W	L	E	Embalaje
000303636	4.1	16	6.6	80/960
000303638	7.7	18.5	7.5	30/360

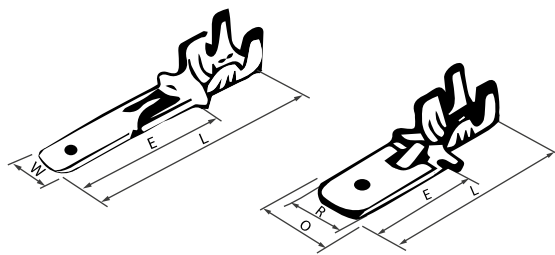

Terminales faston macho

Tipo: **metálico**. Dimensiones en mm.

Referencia	W	L	E	Embalaje
000303637	2.8	21	12	80/960
000303639	6.3	25	13.8	40/480



Puntera hueca aislada en nylon

Tipo: **preaislado**.

Referencia	Color	Sección	Embalaje
000303640	○ Blanco	0.5mm ²	120/1440
000303641	● Azul	0.75mm ²	100/1200
000303642	● Rojo	1mm ²	100/1200
000303643	● Negro	1.5mm ²	80/960
000303644	● Gris	2.5mm ²	60/720
000303645	● Naranja	4mm ²	40/480
000303646	● Verde	6mm ²	30/360



Set terminales

Incluye: 130 terminales **redondos** / 60 terminales **horquilla** redondos / 40 terminales **enchufables hembra** plano / 40 terminales **enchufables macho** plano / 30 **manguitos**.

Referencia	Incluye	Embalaje
000303330	300Ud.	40



Kit tubo termo retráctil

Incluye: 30 Unid. **Ø1.5x100mm** / 30 Unid. **Ø2.5x100mm** / 20 Unid. **Ø4x100mm** / 10 Unid. **Ø6x100mm** / 6 Unid. **Ø10x100mm** / 4 Unid. **Ø13x100mm**

Referencia	Incluye	Embalaje
000303360	100 tubos	30



A M12



B M16



C M18



D M20



IP68

Kit prensa estopa + junta + tuerca

Material: **Nylon PA66**. Bolsa 5 unidades.

Referencia	Artículo	Tuerca	Sección	Dimensión	Embalaje
501000000	A	M12	3-6.5mm	28x17x16mm	20/200
501000001	B	M16	4-8mm	34x22x21mm	20/200
001105534	C	M18	5-10mm	36x24x24mm	20/200
501000002	D	M20	6-11mm	37x27x26mm	20/200



A

0.5-2.5mm²

83.5x26.67mm



B

4-8mm²

83x20x22mm



C

5-10mm²

89x23x22mm



D

5-9mm²/9-12mm²

82x26x23mm



E

10-14mm²

118x30x28mm

Conector estanco + regleta



IP68



450V



50/60Hz

Material: **Nylon PA66**. Nivel inflamabilidad V2. Bolsa 1 unidad.

Referencia	Artículo	Polos	Sección	Amperios	Temperatura	Embalaje
001105532	A	3	0.5-2.5mm ²	24A	T105	10/500
501000003	B	3	0.5-1.5mm ²	17.5A	T105	50/500
501000004	C	3	0.5-1.5mm ²	17.5A	T105	50/500
501000005	D	5	0.5-2.5mm ²	24A	T105	50/500
501000006	E	5	0.5-4.0mm ²	32A	T105	50/500



A

2xM20

42.77x138x35.7mm



B

3xM25

135x105x37mm



C

4xM25

122x98x37mm

Caja conexión estanca + regleta



IP68



450V



Hz

50/60Hz

Material: PC. Nivel inflamabilidad V2. Bolsa 1 unidad.

Referencia	Artículo	Tipo	Polos	Sección	Conexión	Amperios	Temperatura	Embalaje
001105531	A	I	3	0.5-2.5mm ²	2x M20	24A	T105	10/100
501000007	B	Y	3	0.5-2.5mm ²	3x M25	24A	T105	10/100
501000008	C	H	3	0.5-2.5mm ²	4x M25	24A	T105	10/100



IP44



250V



50/60Hz

Caja conexión estanca + regleta

Nivel inflamabilidad V2. Bolsa 5 unidades.

Referencia	Polos	Sección	Amperios	Material	Dimensión	Embalaje
001105533	3	0.5-1.5mm ²	10A	PP	27x42.4x9.3mm	10/100



IP55

Caja conexión redonda

Tipo: **estanca de superficie** con conos. Color: **gris**. Uso externo.

Referencia	Tipo	Dimensión	Embalaje
000301312	Redonda	Ø80x40mm	80



IP55

Caja conexión cuadrada

Tipo: **estanca de superficie** con conos. Color: **gris**. Uso externo.

Referencia	Tipo	Dimensión	Embalaje
000301311	Cuadrada	80x80x40mm	200



IP55

Caja conexión cuadrada

Tipo: **estanca de superficie** con conos. Color: **gris**. Uso externo.

Referencia	Tipo	Dimensión	Embalaje
000301313	Cuadrada	105x105x40mm	10/100



Caja conexión rectangular



IP55

Tipo: **estanca de superficie** con conos. Color: **gris**. Uso externo.

Referencia	Tipo	Dimensión	Embalaje
501000009	Rectangular	240x190x90mm	20
501000010	Rectangular	300x220x120mm	10



Protección estanca para conexiones



IP55

Color: **naranja**. Especial para exterior.

Referencia	Para cable	Dimensión cerrada	Embalaje
001002999	Ø9mm	Ø65x270mm	50



Sistemas de fijación

Material eléctrico

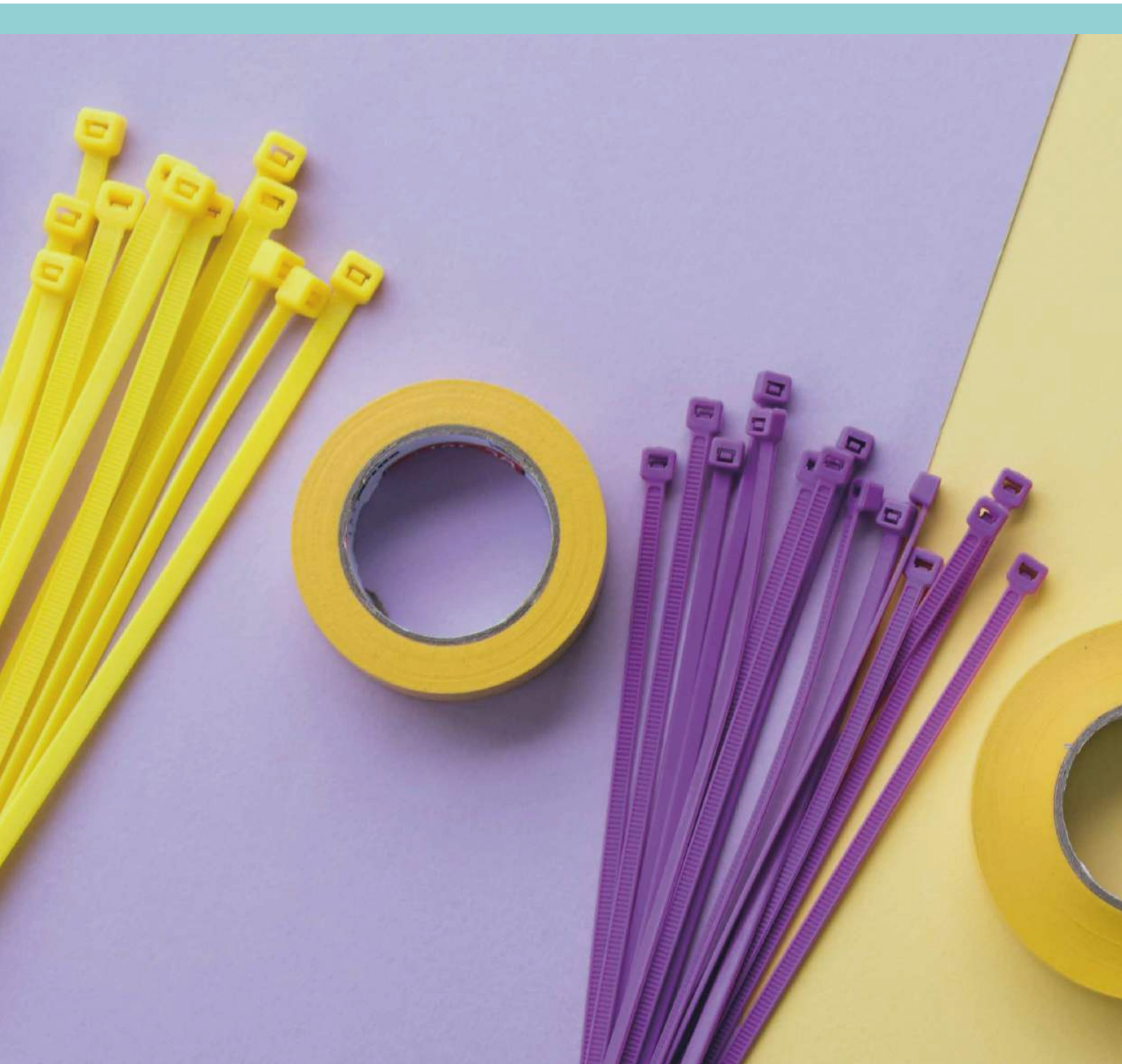



A Ancho 2.5

B Ancho 3.5

C Ancho 4.8

D Ancho 7.9

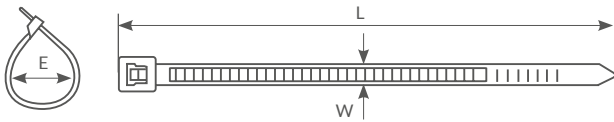

Bridas 100% nylon naturales

Color: **natural**. Bolsa 100 unidades.

Referencia	Artículo	L (mm) (±3)	W (mm) (±0.2)	E (mm) (Mín.-Máx.)	Resistencia ±10% (g)	Embalaje
000900171	A	80	2.5	3-14	0.19	500
000900082	A	100	2.5	3-20.5	0.23	500
000900172	A	130	2.5	3-30	0.32	250
000900083	A	160	2.5	3-39.80	0.41	200
000900173	A	200	2.5	3-52.50	0.5	250
000900084	B	140	3.6	3.5-33	0.59	250
000900174	B	180	3.6	3.5-45	0.79	200
000900085	B	200	3.6	3.5-46	0.83	100
000900175	B	250	3.6	3.5-68	1.07	100
000900086	B	300	3.6	3.5-84	1.27	100
000900176	C	160	4.6	3.5-36.6	0.88	170
000900087	C	200	4.8	3.5-49.5	1.13	100
000900177	C	250	4.8	3.5-65	1.52	100
000900178	C	300	4.8	3.5-81	1.79	100
000900088	C	380	4.8	3.5-106.7	2.3	50
000900179	C	430	4.8	3.5-122.5	2.73	50
000900181	D	300	7.6	8.5-82.8	3.52	50
000900182	D	370	7.6	8.5-103.5	4.25	100
000900089	D	500	7.6	8.5-146.5	5.85	25





- A** Ancho 2.5
- B** Ancho 3.5
- C** Ancho 4.8
- D** Ancho 7.9
- E** Ancho 9.0

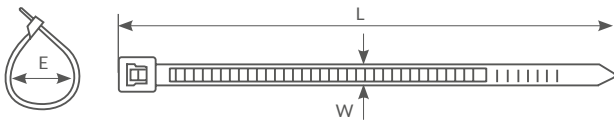

Bridas 100% nylon **negras**

Color: **negro**. Bolsa 100 unidades.

Referencia	Artículo	L (mm) (±3)	W (mm) (±0.2)	E (mm) (Mín.-Máx.)	Resistencia ±10% (g)	Embalaje
000900184	A	80	2.5	3-14	0.19	500
000900092	A	100	2.5	3-20.5	0.23	500
000900185	A	130	2.5	3-30	0.32	250
000900093	A	160	2.5	3-39.80	0.41	200
000900186	A	200	2.5	3-52.50	0.5	250
000900094	B	140	3.6	3.5-33	0.59	250
000900187	B	180	3.6	3.5-45	0.79	200
000900095	B	200	3.6	3.5-46	0.83	100
000900188	B	250	3.6	3.5-68	1.07	100
000900096	B	300	3.6	3.5-84	1.27	100
000900189	C	160	4.8	3.5-36.6	0.88	170
000900097	C	200	4.8	3.5-49.5	1.13	100
000900190	C	250	4.8	3.5-65	1.52	100
000900191	C	300	4.8	3.5-81	1.79	100
000900098	C	380	4.8	3.5-106.7	2.3	50
000900192	C	430	4.8	3.5-122.5	2.73	50
000900194	D	300	7.6	8.5-82.8	3.52	50
000900195	D	370	7.6	8.5-103.5	4.25	100
000900099	D	500	7.6	8.5-146.5	5.85	25
000900100	E	550	8.8	8.5-163.5	8.4	25
000900101	E	760	8.8	8.5-229.50	12.10	10



A Verde

B Natural

C Negro

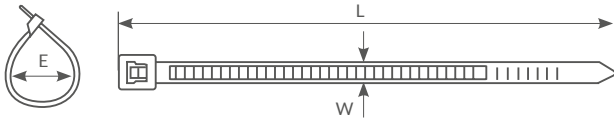

Bridas 100% nylon

Bolsa 25 unidades.

Referencia	Artículo	Color	L (mm) (±3)	W (mm) (±0.2)	E (mm) (Mín.-Máx.)	Resistencia ±10% (g)	Embalaje
000901363	A	● Verde	140	3.6	3.5-33	0.59	200
000901364	A	● Verde	200	3.6	3.5-46	0.83	300
000901365	A	● Verde	200	4.8	3.5-49.5	1.13	300
000901366	A	● Verde	250	4.8	3.5-65	1.52	300
000901367	A	● Verde	300	4.8	3.5-81	1.79	300
000901368	A	● Verde	430	4.8	3.5-122.5	2.73	200
000901369	A	● Verde	370	7.6	8.5-103.5	4.25	160
000901314	B	● Natural	160	2.5	3-39.8	0.41	800
000901315	B	● Natural	140	3.6	3.5-33	0.59	1000
000901316	B	● Natural	200	3.6	3.5-46	0.83	400
000901317	B	● Natural	200	4.8	3.5-49.5	1.13	600
000901318	B	● Natural	250	4.8	3.5-65	1.52	400
000901319	B	● Natural	300	4.8	3.5-81	1.79	400
000901320	C	● Negro	160	2.5	3-39.8	0.41	800
000901321	C	● Negro	140	3.6	3.5-33	0.59	400
000901322	C	● Negro	200	3.6	3.5-46	0.83	400
000901323	C	● Negro	200	4.8	3.5-49.5	1.13	400
000901324	C	● Negro	250	4.8	3.5-65	1.52	400
000901325	C	● Negro	300	4.8	3.5-81	1.79	400



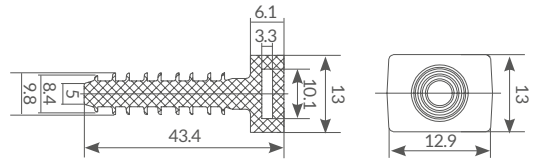

Taco bridas negro

Color: **negro**.

Referencia	Diámetro	Longitud x Ancho	Pack	Embalaje
000900196	Ø7mm	45x4.5mm	100 ud.	50

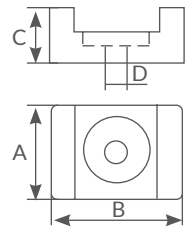

Bases para bridas

Material: **plástico**. Sujeta cables.

Referencia	Diámetro (D)	Dimensión (AxBxC)	Pack	Embalaje
500025007	Ø4.5mm	16x22x9.5mm	100 ud.	100
500025008	Ø6.8mm	16x22x9.5mm	100 ud.	100



A Un orificio



B 3 orificios



C 6 orificios

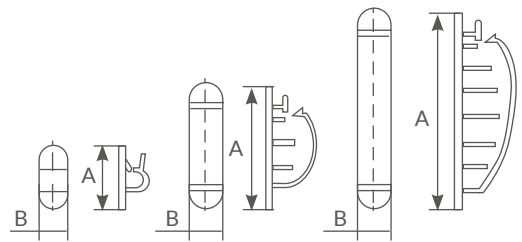

Abrazaderas adhesivas para cable

Material: **plástico**. Para **organizar** los cables.

Referencia	Artículo	Nº orificios	Pack	Dimensión (Ax B)	Embalaje
500025004	A	1	100 ud.	22.5x12.5mm	100
500025005	B	3	100 ud.	54x14.2mm	100
500025006	C	6	100 ud.	87x14.2mm	100

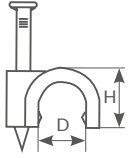

Grapillones para cables manguera redondos

Alta resistencia. Con clavo de acero templado.

Referencia	D (mm)	H (mm)	Pack	Embalaje
000303830	Ø5	6	100 ud.	500
000301300	Ø6	8	100 ud.	300
000301301	Ø7	8.7	100 ud.	300
000301302	Ø8	9.5	100 ud.	200
000303831	Ø9	11	100 ud.	200

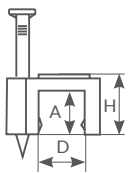

Grapillones para cables telefónicos

Alta resistencia. Con clavo de acero templado.

Referencia	H(mm)	A(mm)	B(mm)	Pack	Embalaje
000303835	5.5	3.5	5	100 ud.	500



Fijadores de tubo con taco

Material: **plástico**. Para la **fijación de tuberías** a la pared o en el techo. Incluye un anclaje de tornillo con un **tornillo autopercutor**.

Referencia	Taco	Pack	Embalaje
500025001	Ø16mm	100 ud.	100
500025002	Ø20mm	100 ud.	100
500025003	Ø25mm	50 ud.	100

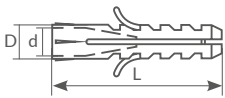

Taco expansión

Material: **nylon**.

Referencia	D (mm)	d (mm)	L (mm)	Color	Pack	Embalaje
000301305	Ø6	4.6	50	● Gris	100 ud.	125
000301306	Ø8	6.5	39	● Gris	100 ud.	40



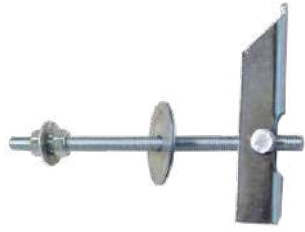

A



B

Taco de vuelco

Bolsa 2 unidades.

Referencia	Artículo	Tipo	Dimensión	Embalaje
000301307	A	Con espiga	Ø5x90mm	300
000301308	B	Con gancho	Ø5x90mm	250



Tornillo con taco

Material: **nylon**. Cabeza Philips.

Referencia	Dimensión	Embalaje
000301309	Ø10x80mm	50/1000



Canalización y ordenación de cables

Material eléctrico



Adhesiva

MINI CANALETAS

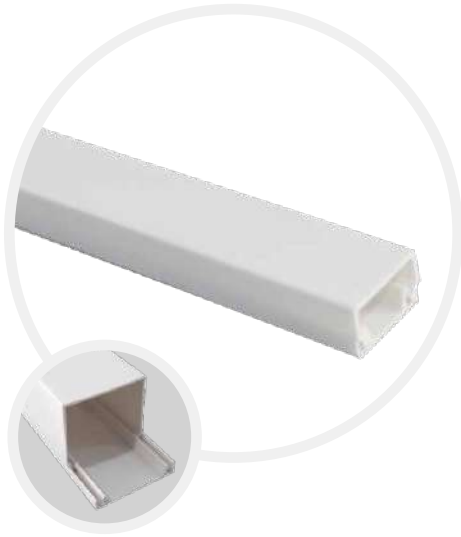

A

8x12mm 10x15mm
10x20mm

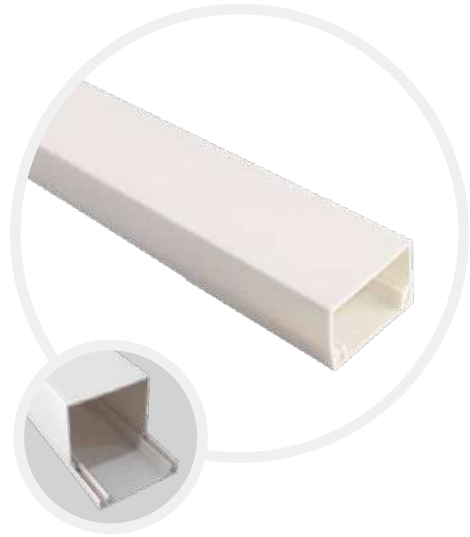

B

12x12mm 16x16mm
16x25mm



IP40

Mini-canaleta adhesiva PVC 2M

Tipo: **auto extingüible**. Con tapa de cierre de máxima protección.
 Con cinta adhesiva. Color: blanco. Ideal para todo tipo de cableados.
 Fácil instalación. No metálica. Para impactos ligeros. **No propagador de llama**.
 Con **aislamiento eléctrico**. Sin continuidad eléctrica.
 Protección baja interior y exteriormente contra contaminantes.
 Clasificación frente a temperaturas: 222.

Referencia	Artículo	Dimensión	Grosor	Embalaje
000300610	A	8x12mm	0.75mm	50
000300611	A	10x15mm	0.80mm	50
000300612	A	10x20mm	0.80mm	50
000300613	B	12x12mm	0.60mm	50
000300614	B	16x16mm	1.00mm	40
000300615	B	16x25mm	0.95mm	25



A tornillo

CANALETAS

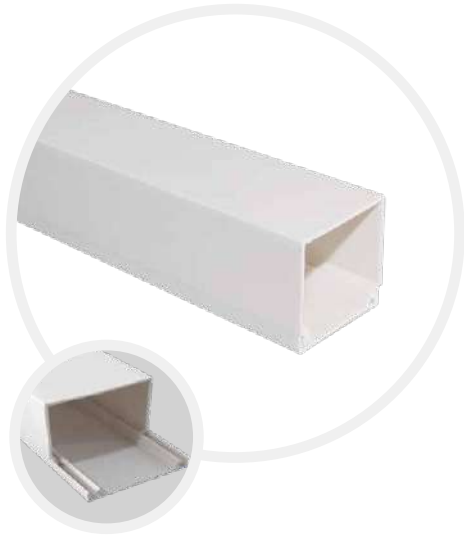

A

40x60mm

40x100mm

50x75mm

60x100mm



B

25x25mm

25x40 mm

40x40mm



IP40

Canaleta fijación a tornillo PVC 2M

Fijación a tornillo. Color: blanco. Ideal para todo tipo de cableados. Fácil instalación. No metálica. Para impactos ligeros. **No propagador de llama.** Con **aislamiento eléctrico.** Sin continuidad eléctrica. Protección baja interior y exteriormente contra contaminantes. Clasificación frente a temperaturas: 222.

Referencia	Artículo	Dimensión	Grosor	Embalaje
000300619	A	40x60mm	1.4mm	8
000303359	A	40x100mm	1.5mm	4
000300620	A	50x75mm	1.45mm	4
000300621	A	60x100mm	1.80mm	4
000300616	B	25x25mm	1.00mm	20
000300617	B	25x40mm	1.10mm	10
000300618	B	40x40mm	1.38mm	10

Adhesiva

CANALETAS



10x35mm

15x50mm

20x70mm

25x90mm



IP40

Canaleta adhesiva PVC 2M

Tipo: **auto extingible**. Con tapa de cierre de máxima protección.
 Con cinta adhesiva. Color: blanco. Ideal para todo tipo de cableados.
 Fácil instalación. No metálica. Para impactos ligeros. **No propagador de llama**.
 Con **aislamiento eléctrico**. Sin continuidad eléctrica.
 Protección baja interior y exteriormente contra contaminantes.
 Clasificación frente a temperaturas: 222.

Referencia	Dimensión	Grosor	Embalaje
000303355	10x35mm	1.35mm	25
000303356	15x50mm	1.60mm	25
000303357	20x70mm	2.00mm	10
000303358	25x90mm	2.00mm	10



Ángulo exterior para canaletas

Bolsa 4 unidades.

Referencia	Dimensión	Embalaje
000304638	10x15mm	25/80
000304639	16x16mm	25/80
000304640	10x20mm	25/80
000304641	16x25mm	25/80
000304642	25x40mm	25/80



Ángulo interior para canaletas

Bolsa 4 unidades.

Referencia	Dimensión	Embalaje
000304646	10x15mm	25/80
000304647	16x16mm	25/80
000304648	10x20mm	25/80
000304649	16x25mm	25/80
000304650	25x40mm	25/80





Tapa final para canaletas

Bolsa 4 unidades.

Referencia	Dimensión	Embalaje
000304678	10x15mm	25/80
000304679	16x16mm	25/80
000304680	10x20mm	25/80
000304681	16x25mm	25/80
000304682	25x40mm	25/80



Organizador de cables

Con clip para su fácil colocación.

Referencia	Longitud	Diámetro	Embalaje
000300146	1.8M	Ø20mm	30
000300147	2.5M	Ø25mm	20



Medición eléctrica

Material eléctrico

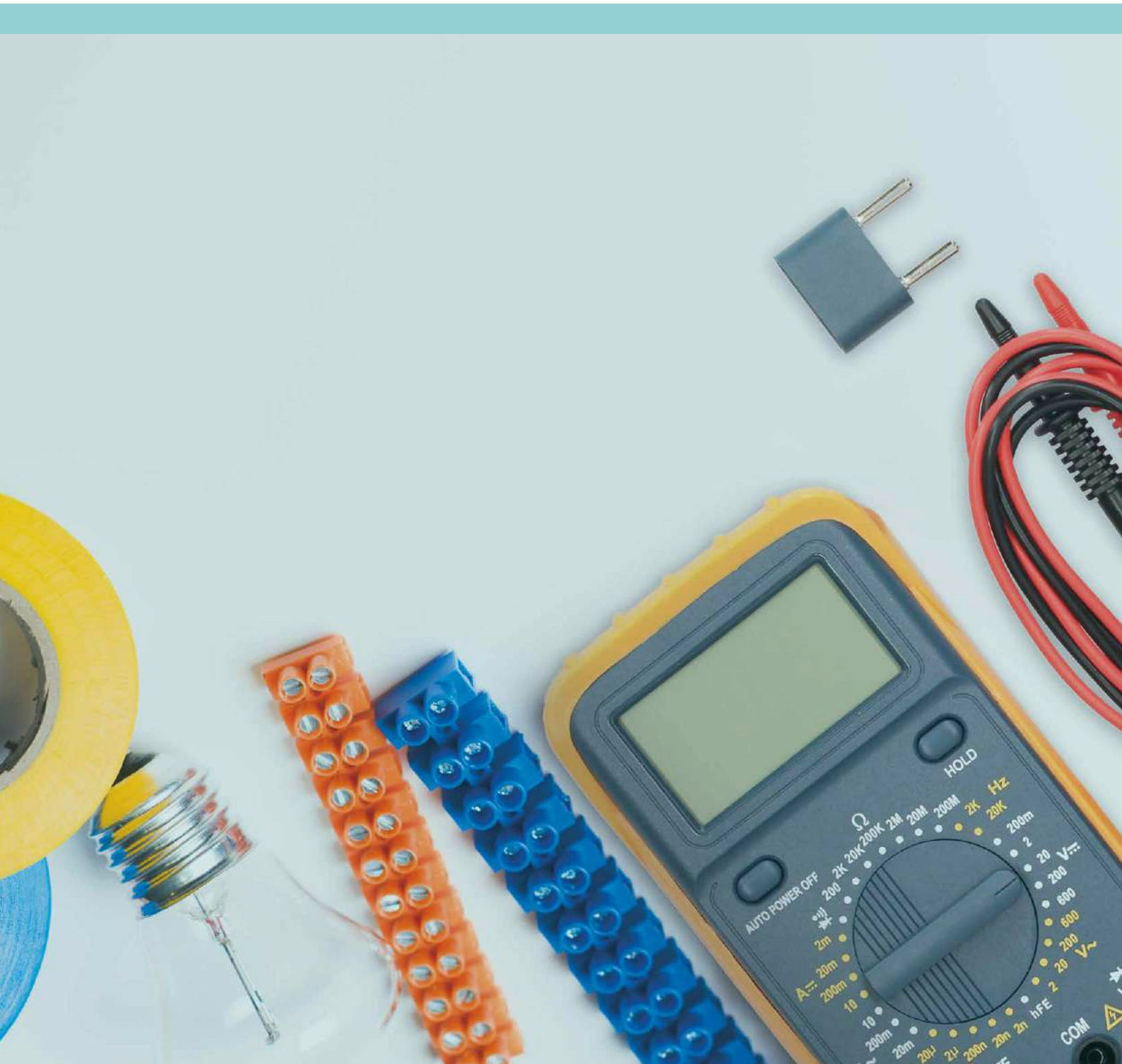



Multímetro digital

Voltios DC: 200mV / 1000V. **Voltios AC:** 200V / 750V. **Intensidad DC:** 2000 μ A / 10A. **Resistencia:** 200 Ω / 2M Ω .
Con salida impulsos, test transistor, test diodos, indicador acústico, ganancia de corriente (hFE) y onda cuadrada.
 Con puntas y cable. Usa 1 pila de 9V(incluida). Blíster.

Referencia	Tipo	Dimensión	Embalaje
001400259	Digital	70x28x126mm	60



Multímetro digital

Voltios DC: 200mV-600V, $\pm(0.5\%+2)$. **Voltios AC:** 200V-600V, $\pm(1.2\%+10)$. **Intensidad DC:** 2000 μ A / 10A, $\pm(1\%+2)$.
Resistencia: 200 Ω / 2M Ω , $\pm(0.8\%+2)$. **Con memoria de datos, test transistor, test diodos, ganancia de corriente y puntas para el multímetro.** Usa 1 pila de 9V(incluida). Blíster.

Referencia	Tipo	Dimensión	Embalaje
001401279	Digital	38x31x69mm	40

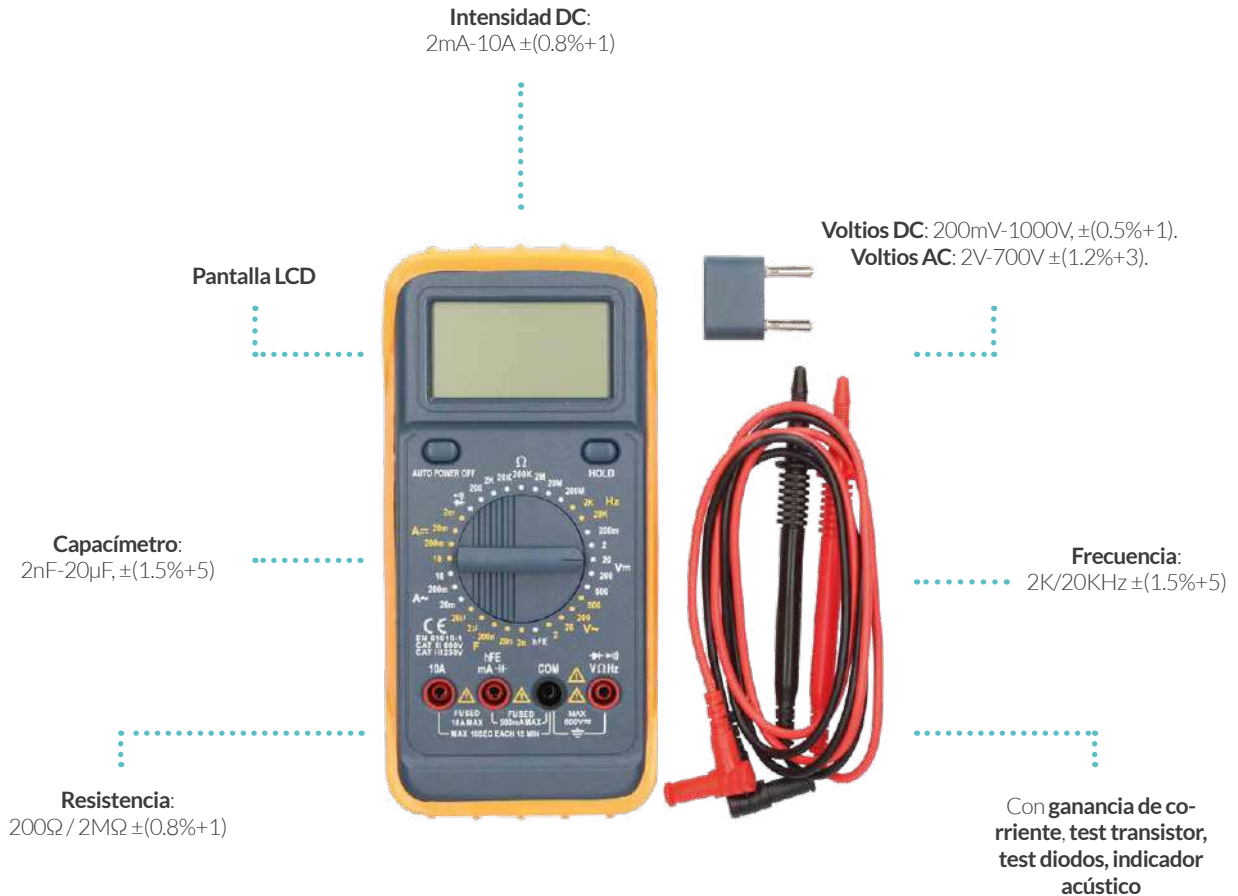

Multímetro digital

Voltios DC: 200mV-1000V, $\pm(0.5\%+1)$. **Voltios AC:** 2V-700V $\pm(1.2\%+3)$. **Intensidad DC:** 2mA-10A $\pm(0.8\%+1)$. **Resistencia:** 200 Ω / 2M Ω $\pm(0.8\%+1)$. **Capacímetro:** 2nF-20 μ F, $\pm(1.5\%+5)$. **Frecuencia:** 2K/20KHz $\pm(1.5\%+5)$. Con **ganancia de corriente**, test transistor, test diodos, indicador acústico, pantalla LCD (27x60mm) y botón de encendido y apagado. Usa 1 pila de 9V(incluida). Blíster.

Referencia	Tipo	Dimensión	Embalaje
001401280	Digital	90x31.5x189mm	20



Mini-multímetro digital profesional pinza

Voltios DC: 600V \pm 1%. **Voltios AC:** 600V \pm 1.2%.
Intensidad AC: 2-20-200-400A. **Resistencia:** 200 Ω / 20 Ω \pm 1.5%. Usa 2 pilas de AAA (incluidas). Blíster.

Referencia	Tipo	Dimensión	Embalaje
001403324	Digital	70x34x151mm	100



Multímetro digital profesional pinza

Voltios DC: 200m/20/1000V, \pm (0.5%+1). **Voltios AC:** 200m/20/750V, \pm (1%+4). **Intensidad AC:** 20A-1000A \pm (2%+5).
Resistencia: 2000/20K / 200K Ω , \pm (2%+2). **Frecuencia:** 2KHz, \pm (1.5%+5). **Temperatura:** 0°C-750°C, \pm (1%+2).
 Con **indicador acústico, memoria de lectura, prueba de aislamiento, test de diodos**.
 Protección de sobrecargas e indicador del estado de la batería. Con puntas y cable. Usa una pila de 9V (incluida). Blíster.

Referencia	Tipo	Dimensión	Embalaje
001401629	Digital	90x37x230mm	20



Tester de pilas

Comprobador de pilas AA, AAA, C, D y 9V. Blíster.

Referencia	Embalaje
001401281	100



Comprobador de voltaje



450V



50/60Hz

Verifica circuitos. Indica voltaje **AC/DC** en 6,12,24,50,110, 220y 380V. Blíster.

Referencia	Dimensión	Embalaje
001400120	30x25x190mm	10/50





Interruptores

Material eléctrico

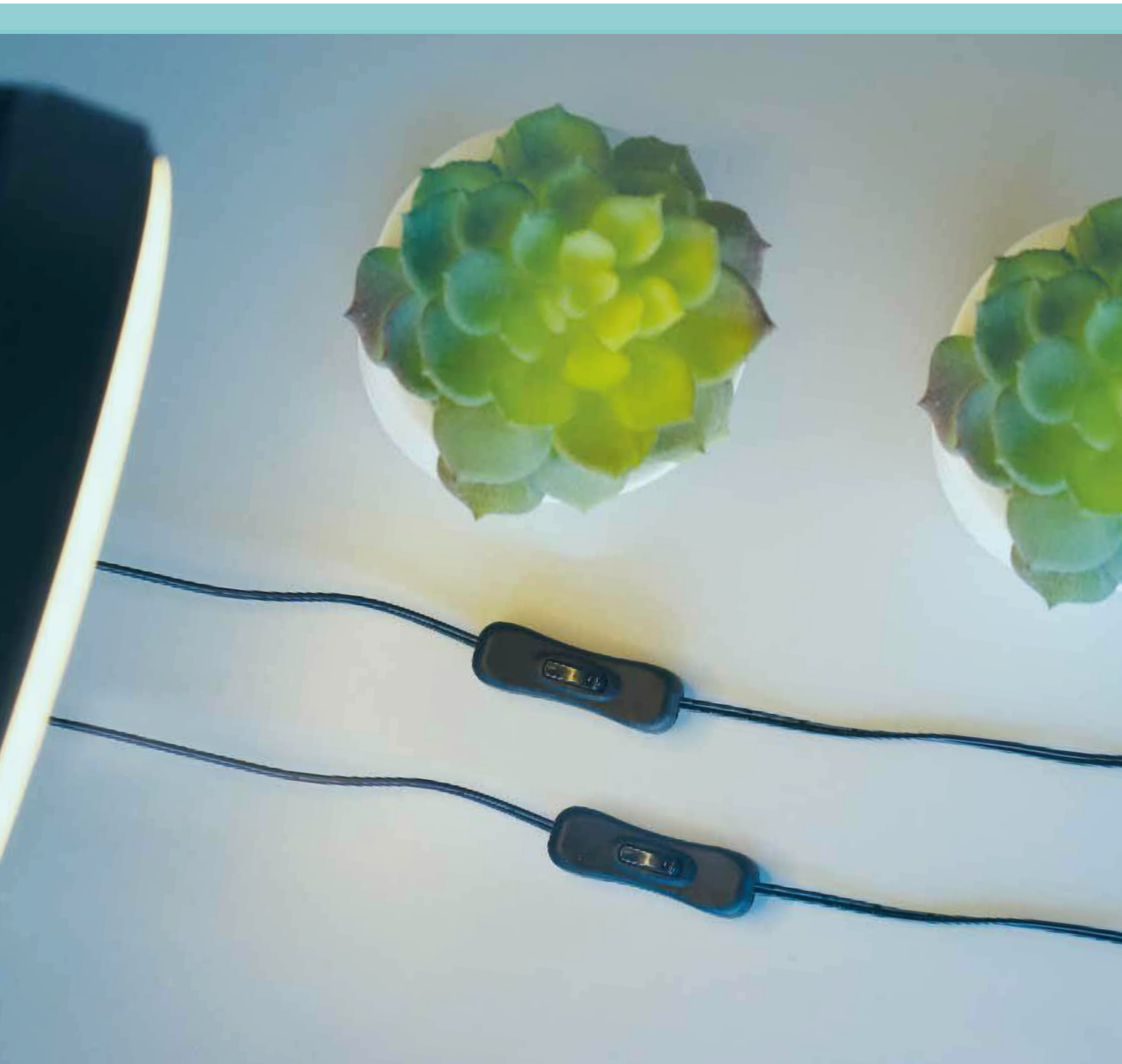



25x15x60mm 250V

Interruptores de paso

Tipo: rectangular. Conexión fácil y rápida.

Referencia	Tipo	Amperios	Color	Embalaje
001103385	Bipolar	2A	○ Blanco	100/1000
001103386	Bipolar	2A	● Negro	100/1000
001101094	Unipolar	2A	○ Blanco	100/1000
001101095	Unipolar	2A	● Negro	100/1000
001101818	Unipolar	2A	● Marrón	100/1000
102515000	Unipolar	6A	○ Blanco	100/1000
102515001	Unipolar	6A	● Negro	100/1000
102515002	Unipolar	6A	● Dorado	100/1000
102515003	Unipolar	6A	○ Transparente	100/1000



25x12x26mm 250V

Interruptor de paso

Tipo: redondo. Interruptor: Ø10mm. Conexión fácil y rápida.

Referencia	Tipo	Amperios	Color	Embalaje
001100363	Unipolar	2A	○ Blanco	100/2000





52x17.6x50mm



250V

Interrupzor para armarios

Sección: 2x0.75mm.

Referencia	Tipo	Amperios	Color	Embalaje
001101820	Unipolar	2A	● Negro	25/500



Ø70x29mm



250V

Interrupzor de pie

Sección: 2x0.75mm.

Referencia	Tipo	Amperios	Color	Embalaje
001101096	Unipolar	2A	○ Blanco	25/500
001100364	Unipolar	2A	● Negro	25/500



A



Conexión



B



Conexión



C



Conexión



D



Conexión



E



Conexión



F



Conexión



G



Conexión



H



Conexión

Interruptores mini

125-250V 50/60Hz

Bolsa 5 unidades.

Referencia	Artículo	Tipo	Función	Amperios	Dimensión	Embalaje
001105500	A	SPST	On/Off con luz	10(4)A	21x15mm	10/400
001105501	B	DPST	On/Off	10(4)A	21x15mm	10/400
001105502	C	SPST	On/Off con luz	16(4)A	30.6x13.5mm	10/200
001105503	D	SPST	On/Off con luz	10(4)A	Ø23mm	10/400
001105504	E	SPDT	On/On	10(4)A	Ø23mm	10/400
001105505	F	DPST	On/Off con luz	16(4)A	31.8x25mm	10/100
001105506	G	DPST	On/Off	16(4)A	31.8x25mm	10/100
001105507	H	DPDT	On/Off con luz	16(4)A	30.6x25.6	10/100



A



Conexión



B



Conexión



C



Conexión



D



Conexión



E



Conexión

Interruptores mini



125-250V



50/60Hz

Bolsa 5 unidades.

Referencia	Artículo	Tipo	Función	Amperios	Dimensión	Voltaje	Embalaje
001105508	A	SPST	On/Off	6A	13x8mm	125V	10/200
001105509	B	SPDT	On/On	6A	13x8mm	125V	10/200
001105510	C	DPST	On/Off/On	15A	33x20mm	250V	10/100
001105511	D	SPST Unipolar	On/Off	15A	29x15.9mm	250V	10/100
001105512	E	DPST Bipolar	On/Off	15A	33x19.5mm	250V	10/100



Interruptor automático flotante



IP68



16A



230V



50Hz

Ideal para bombas de agua. Temp. máx.: 50°C.

Regulador de nivel de líquidos compuesto por el interruptor (boya), contrapeso y cable de conexiones de neopreno.

Referencia	Cable	Sección	Longitud	Embalaje
000600267	H05RR-F	(3x1.0mm)	3M	10
000600412	H05RR-F	(3x1.0mm)	5M	10



Casquillos

Material eléctrico





A GU10 > E27



B GU10 > E14



C E27 > GU10



D E14 > GU10



E E27 > E14



F E14 > E27



G E40 > E27



IP20



230V



50/60Hz

Adaptadores

Material: **plástico + aluminio.**

Incluye todos los accesorios para el montaje menos el cable.

Referencia	Artículo	Casquillo	Embalaje
002201343	A	De GU10 a E27	25/500
002201344	B	De GU10 a E14	25/500
002201333	C	De E27 a GU10	12/360
002201334	D	De E14 a GU10	12/360
002201335	E	De E27 a E14	12/600
002201336	F	De E14 a E27	12/600
002201337	G	De E40 a E27	25/500



A



B



C



D



E

Portalámparas cerámicos



250V

Color: blanco. Rosca: M10.

Referencia	Artículo	Tipo	Casquillo	Amperios	Dimensión	Embalaje
101505000	A	Reforzado	E14	2A	Ø28x53mm	25/200
101505001 ★	B	Reforzado	E27	4A	Ø40x57mm	25/200
002200286	C	Liso	E27	4A	Ø35.6x50mm	25/500
002200730	D	Reforzado	E27	4A	Ø41x60mm	25/500
101505002 ★	E	Reforzado	E27	4A	Ø40x46mm	25/200



Ø27x52.5mm



250V

Portalámparas baquelita liso E14

Tipo: liso. Rosca: M10.

Referencia	Casquillo	Amperios	Color	Embalaje
002200282	E14	2A	○ Blanco	50/1000
002200283	E14	2A	● Negro	50/1000



Ø38x55.5mm



250V

Portalámparas baquelita liso E27

Tipo: liso. Rosca: M10.

Referencia	Casquillo	Amperios	Color	Embalaje
002201261	E27	4A	○ Blanco	25/500
002201262	E27	4A	● Negro	25/500



Ø26x57mm



250V

Portalámparas termoplástico liso E14

Tipo: liso. Rosca: **M10**. Temperatura: **T210**.

Referencia	Casquillo	Amperios	Color	Embalaje
101530000	E14	2A	○ Blanco	10/300
101530001	E14	2A	● Negro	10/300



Ø37x59mm



250V

Portalámparas termoplástico liso E27

Tipo: liso. Rosca: **M10**. Temperatura: **T210**.

Referencia	Casquillo	Amperios	Color	Embalaje
101530004	E27	4A	○ Blanco	10/400
101530005	E27	4A	● Negro	10/400



Ø28x57mm



250V

Portalámparas metálico E14

Tipo: liso. Rosca: **M10**. Color: dorado. Potencia: **máx. 40W**. Material: **metal**.

Referencia	Casquillo	Amperios	Embalaje
101520001	E14	2A	25/200



Ø38x58mm



250V

Portalámparas metálico E27

Tipo: liso. Rosca: **M10**. Color: dorado. Potencia: **máx. 60W**. Material: **latón**.

Referencia	Casquillo	Amperios	Embalaje
002200292	E27	4A	25/300



Ø55x45mm 250V

Portalámparas baquelita E14

Tipo: semi roscado. Rosca: **M10**. Color: negro.
Con arandela: Ø45 / Grosor: 12mm.

Referencia	Casquillo	Amperios	Embalaje
002200732	E14	2A	30/600



Ø33.5x53.5mm 250V

Portalámparas baquelita E14

Tipo: semi roscado. Rosca: **M10**. Color: negro.
Con arandela: Ø43 / Grosor: 17mm.

Referencia	Casquillo	Amperios	Embalaje
101535002	E14	2A	25/500



Ø45x59mm



250V

Portalámparas baquelita E27

Tipo: semi roscado. Rosca: **M10**. Color: negro.
Con arandela: Ø57 / Grosor: 12mm.

Referencia	Casquillo	Amperios	Embalaje
002200734	E27	4A	16/320



Ø46.5x53mm



250V

Portalámparas baquelita E27

Tipo: semi roscado. Rosca: **M10**. Color: negro.
Con arandela: Ø57 / Grosor: 13mm.

Referencia	Casquillo	Amperios	Embalaje
101535001	E27	4A	16/256



Ø43x57mm



250V

Portalámparas termoplástico con arandela

Arandela: Ø58mm / Grosor: 20mm. Rosca: **M10**. Temperatura: **T210**.

Referencia	Casquillo	Amperios	Color	Embalaje
101530002	E14	2A	○ Blanco	10/200
101530003	E14	2A	● Negro	10/200



Ø45x60mm



250V

Portalámparas termoplástico con arandela

Arandela: Ø50mm / Grosor: 10mm. Rosca: **M10**. Temperatura: **T210**.

Referencia	Casquillo	Amperios	Color	Embalaje
002200289	E27	4A	○ Blanco	10/300
002200290	E27	4A	● Negro	10/300



Ø26x62mm



250V

Portalámparas metálico E14

Tipo: roscado. Rosca: **M10**. Color: dorado.
Potencia: **máx. 60W**. Material: **latón**. Con arandela: Ø39 / Grosor: 10mm.

Referencia	Casquillo	Amperios	Embalaje
002200293	E14	2A	50/400



Ø40x55.4mm



250V

Portalámparas metálico E27

Tipo: roscado. Rosca: **M10**. Color: dorado.
Potencia: **máx. 60W**. Material: **metal**. Con arandela: Ø60 / Grosor: 10mm.

Referencia	Casquillo	Amperios	Embalaje
101520002	E27	4A	25/200



A



B

A



4A

250V

Portalámparas superficie E27

Potencia: **máx. 40W**. Rosca: **M10**. Distancia entre agujeros: 62mm. Color: blanco.

Referencia	Artículo	Tipo	Casquillo	Material	Dimensión	Embalaje
002200287	A	Recto	E27	Termoplástico	75x55mm	10/200
002200288	B	Curvo	E27	Termoplástico	75x60mm	10/200



Portalámparas S14s



83x34.7mm

250V

Material: **plástico**. Color: blanco.

Referencia	Casquillo	Amperios	Embalaje
101540001	S14s	1A	20/200

Portalámparas S14d



60x34mm

250V

Material: **plástico**. Color: blanco.

Referencia	Casquillo	Amperios	Embalaje
101540002	S14d	1A	20/200

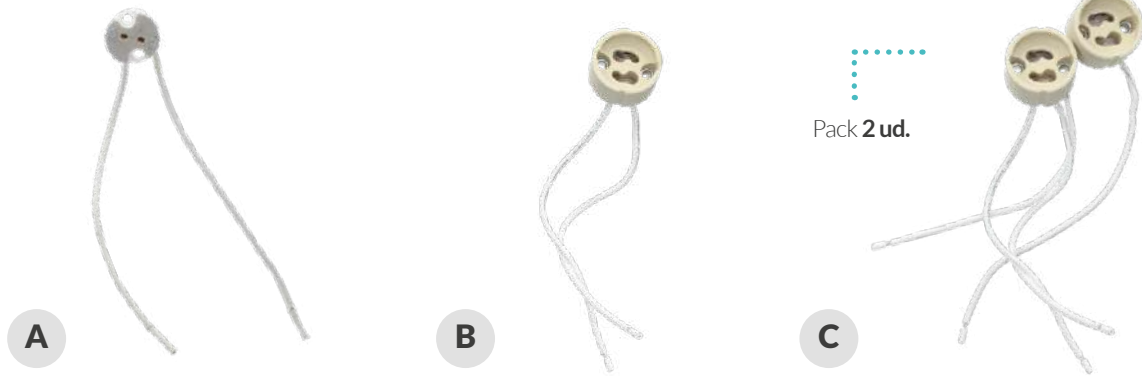

Portalámparas dicroicas

Color: blanco.

Referencia	Artículo	Casquillo	Amperios	Temperatura	Voltaje	Embalaje
002200295	A	MR16/GX5.3/GU5.3	10A	T300	12V	50/2000
002200296	B	GU10	2A	T250	250V	50/1000
101510000	C	GU10	2A	T250	250V	10/100



D



E

Portalámparas E10

Uso exclusivo manualidades. Color: blanco.

Referencia	Artículo	Tipo	Casquillo	Embalaje
002201218	D	Cerámico	E10	100/1000
002200940	E	Puente latonado	E10	100/4000



24V

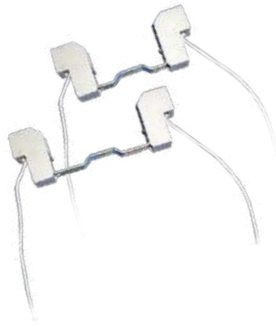

Portalámparas R7s

250V

Casquillo: **R7s**.

Referencia	Para	Amperios	Embalaje
002201219	78mm	0.6A	24/240
002201220	118mm	2A	20/200



Portalámparas R7s

250V

Casquillo: **R7s**. Cable: Ø0.75x150mm. Bolsa 20ud.

Referencia	Casquillo	Amperios	Embalaje
101540000	R7s	4A	20/1000



Portalámparas Gx53

250V

Color: blanco. Cable: 0.5x150mm. Casquillo: **Gx53**. Bolsa 20ud.

Referencia	Casquillo	Amperios	Embalaje
002203323	Gx53	8A	500



Portacebador

250V

Color: blanco. 250V. T110

Referencia	Amperios	Embalaje
002201221	2A	120/1200

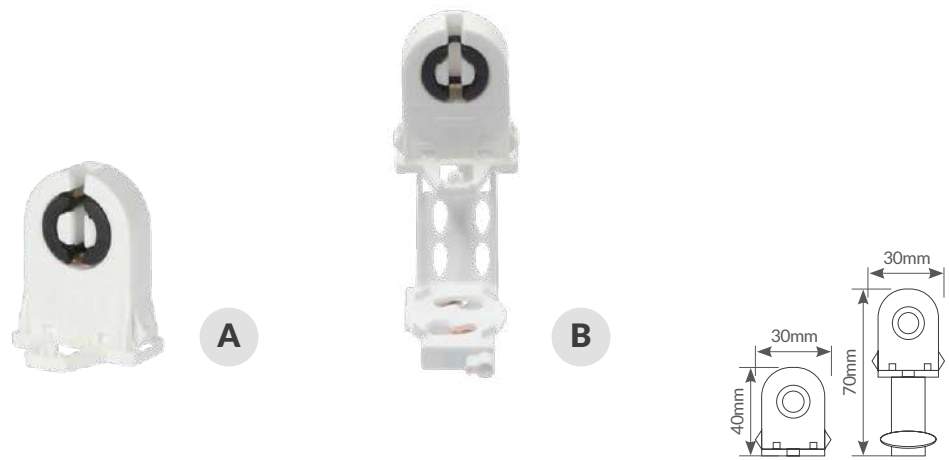

Cebador y portalámparas para tubos G13

Color: blanco. 250V.

Referencia	Artículo	Tipo	Casquillo	Embalaje
002201222	A	Portalámparas	G13	100/1000
002201223	B	Portalámparas + portacebador	G13	30/600



Portalámparas con sensor de movimiento



Máx. radio de detección: 6M. **Altura de instalación** 2-3.5M.
Tiempo regulable: 10seg. a 5min. Color: blanco.

Referencia	Casquillo	Área detección	Embalaje
002001129	E27	360°	50



Portalámparas tipo vela

Diámetro superior: Ø30mm. Diámetro inferior: Ø25mm.

Referencia	Artículo	Casquillo	Color	Altura	Embalaje
002203325	A	E14	○ Blanco	65mm	50/500
002203326	B	E14	○ Blanco	85mm	50/500



Portalámparas tipo vela

Diámetro superior: Ø30mm. Diámetro inferior: Ø25mm.

Referencia	Artículo	Casquillo	Color	Altura	Embalaje
002203362	C	E14	● Crema	65mm	50/500
002203363	D	E14	● Crema	85mm	50/500



A



B



C



D



IP20



220-240V



50/60Hz

Portalámparas decorativo E27

Incluye todos los accesorios para el montaje menos el cable.

Referencia	Artículo	Casquillo	Material	Dimensión	Embalaje
002204630	A	E27	Cobre	Ø40x97mm	100
002204632	B	E27	Metal + PVC	Ø42x80mm	100
002204634	C	E27	Cemento	Ø52.5x92mm	100
002204636	D	E27	Madera	Ø60.5x70mm	100



E



F



G



H



IP20



220-240V



50/60Hz

Soporte techo florón

Incluye todos los accesorios para el montaje menos el cable.

Referencia	Artículo	Material	Dimensión	Embalaje
000704631	E	Cobre	Ø70x70mm	100
000704633	F	Metal + PVC	Ø109x66mm	100
000704635	G	Cemento	Ø100x20mm	50
000704637	H	Madera	Ø100x20mm	50



Varilla hueca roscada

Para portalámparas.

Referencia	Dimensión	Embalaje
002204617	Ø9.6x20mm	10/300
002204618	Ø9.6x35mm	10/300



Prensacable

Para portalámparas y florones.

Referencia	Color	Embalaje
002204619	● Negro	10/300
002204620	○ Blanco	10/300
002204621	○ Transparente	10/300



Clavijas y bases aéreas

Material eléctrico





A



B

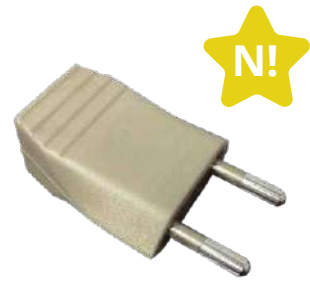

C



250V



50Hz

Clavija bipolar

Retractable.

Referencia	Artículo	Espiga	Amperios	Color	Material	Embalaje
000200483	A	Ø4mm	10A	● Negro	Policarbonato	50/1000
000200484	B	Ø4mm	10A	○ Blanco	Policarbonato	50/1000
102010002 ★	C	Ø4mm	10A	● Dorado	Policarbonato	50/1000



250V



50Hz

Clavija bipolar

Retractable. Con TT lateral.

Referencia	Espiga	Amperios	Color	Material	Embalaje
000203998	Ø4.8mm	16A	○ Blanco	Policarbonato	25/600





250V



50Hz

Clavija bipolar

Retractable. Con TT lateral.

Referencia	Espiga	Amperios	Color	Material	Embalaje
000200057	Ø4.8mm	10/16A	○ Blanco	Termoplástico	40/480



A



B



CHILD



250V



50Hz

Base enchufe aérea

Con protección para niños. Color: blanco. Retractable.

Referencia	Artículo	Para espiga	Amperios	Color	Material	Embalaje
000200485	A	Ø4mm	10A	○ Blanco	Polycarbonato	50/500
102010001 ★	B	Ø4mm	10A	● Negro	Polycarbonato	50/500



Base enchufe aérea



CHILD



250V



50Hz

Con protección para niños. Color: blanco. Con TT lateral. Retractilado.

Referencia	Para espiga	Amperios	Color	Material	Embalaje
000200056	Ø4.8mm	10/16A	○ Blanco	Termoplástico	25/200

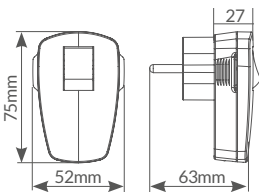

Clavija enchufe con interruptor



220-240V



50Hz

Fácil conexión. Color: blanco. Retractilado. IP20.

Referencia	Espiga	Amperios	Material	Embalaje
102010004	Ø4.8mm	16A	PC	10/240

*Conexión de info técnica.



220-240V 50Hz

Clavija ultrafina

Con TT lateral. Entrada de cable recta. **Con asa** para extraer mejor la clavija. Fácil conexión. Color: blanco. Blíster.

Referencia	Potencia	Espiga	Embalaje
000203391	3680W	Ø4.8mm	10/100

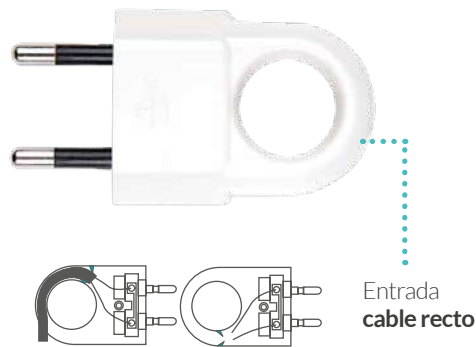

250V 50Hz

Clavija bipolar

Con sistema de agarre **ergonómico**. Color: blanco. Retractable.

Referencia	Espiga	Amperios	Material	TT lateral	Embalaje
000201276	Ø4mm	10A	Polycarbonato	No	50/1000





Clavija bipolar



250V



50Hz

Con sistema de agarre ergonómico. Color: blanco. Retractable.

Referencia	Espiga	Amperios	Material	TT lateral	Embalaje
000201277	Ø4.8mm	16A	Policarbonato	Sí	30/300



CHILD



16A



250V



50Hz

Base aérea

Con sistema de agarre ergonómico. Color: blanco. Con protección para niños. Retractable.

Referencia	Para espiga	Material	TT lateral	Embalaje
000201278	Ø4.8mm	Policarbonato	Sí	12/240



A



B



250V



50Hz

Clavija bipolar

Con TT lateral de goma con entrada de cable recta. 16A. Retractilado.

Referencia	Artículo	Espiga	Amperios	Color	Material	TT lateral	Embalaje
000200059	A	Ø4.8mm	16A	● Negro	Goma	Sí	25/400
000200198	B	Ø4.8mm	16A	○ Blanco	Goma	Sí	25/400



Clavija bipolar hornos / cocinas

Con TT lateral para hornos y cocinas. Color: blanco. Retractilado.

Referencia	Potencia	Amperios	Embalaje
000200240	Máx. 6000W	25A	10/100



250V



50Hz



250V



50Hz

Base empotrar hornos / cocinas

Con TT lateral para hornos y cocinas. Color: blanco. Retractilado.

Referencia	Potencia	Amperios	Embalaje
102005000	Máx. 6000W	25A	12/240



C



D



CHILD



250V



50Hz

Base aérea bipolar

Con TT lateral de goma con entrada de cable recta. Con protección para niños. Retractilado.

Referencia	Artículo	Para espiga	Amperios	Color	Material	TT lateral	Embalaje
000200060	C	Ø4.8mm	16A	● Negro	Goma	Sí	25/250
000200199	D	Ø4.8mm	16A	○ Blanco	Goma	Sí	25/250



250V



50Hz

Clavija industrial bipolar

Con TT lateral de goma con entrada de cable recta. VDE.
Color: negro. 16A. Retractilado.

Referencia	Espiga	Embalaje
000200624	Ø4.8mm	25/250



250V



50Hz

Base aérea bipolar

Con TT lateral **impermeable** de goma + PVC con entrada de cable recta.
Con protección para niños. Color: gris. Retractilado.

Referencia	Para espiga	Amperios	Embalaje
000200605	Ø4.8mm	10/16A	25/200





Clavija bipolar

Con TT lateral **impermeable** de goma + PVC con entrada de cable recta.
Color: negro. Retractilado.

Referencia	Espiga	Amperios	Embalaje
102015000	Ø4.8mm	16A	10/100



Base aérea bipolar con tapa

Con TT lateral **impermeable** de goma + PVC con entrada de cable recta.
Con protección para niños. Color: negro. Retractilado.

Referencia	Para espiga	Amperios	Embalaje
102015001	Ø4.8mm	16A	10/100



Clavija bipolar con tirador

Con TT lateral **impermeable** de goma + PVC con entrada de cable recta. **Con tirador** para extraer mejor la clavija. Color: negro. Retractilado.

Referencia	Espiga	Amperios	Embalaje
102015002	Ø4.8mm	16A	10/100



Base aérea bipolar con tapa y tirador

Con TT lateral **impermeable** de goma + PVC con entrada de cable recta. **Con tirador** para extraer mejor la clavija. Con protección para niños. Color: negro. Retractilado.

Referencia	Espiga	Amperios	Embalaje
102015003	Ø4.8mm	16A	10/100



A
3P (2P + T)



B
4P (3P + T)



C
5P (3P + T + N)

Clavija cetac



Retractable.

Referencia	Artículo	Polos	Amperios	Voltaje	Embalaje
002300332	A	3P (2P + T)	16A	220-250V	10/42
002300333	A	3P (2P + T)	32A	220-250V	10/60
002300384	B	4P (3P + T)	16A	380-415V	10/42
002300385	B	4P (3P + T)	32A	380-415V	10/60
002300388	C	5P (3P + T + N)	16A	240-415V	10/120
002300389	C	5P (3P + T + N)	32A	240-415V	10/60



A

3P (2P+T)



B

4P (3P+T)



C

5P (3P+T+N)

Base aérea **cetac**



IP44

Con tapa. Retractilado.

Referencia	Artículo	Polos	Amperios	Voltaje	Embalaje
002300334	A	3P (2P+T)	16A	220-250V	10/120
002300335	A	3P (2P+T)	32A	220-250V	10/60
002300386	B	4P (3P+T)	16A	380-415V	10/120
002300387	B	4P (3P+T)	32A	380-415V	10/60
002300390	C	5P (3P+T+N)	16A	240-415V	10/60
002300391	C	5P (3P+T+N)	32A	240-415V	10/60





IP44



250V

Adaptador clavija

Espiga: Ø4.8mm. De clavija cetac 3P (2P + T) a base aérea sucko.

Referencia	Amperios	Voltaje	Embalaje
002300738	16A	250V	10/100



A

5P (3P+T+N)



B

5P (3P+T+N)



IP44



16A



240V

Prolongador convertidor cetac

En bolsa.

Referencia	Artículo	Convertidor	Sección	Longitud	Embalaje
002300232	A	De clavija sucko a base cetac 3P (2P + T)	(3x1.5mm)	1M	12/120
002300233	B	De clavija cetac 3P (2P + T) a base sucko	(3x1.5mm)	1M	10/60



Adaptadores y enchufes

Material eléctrico





Para dispositivos de 2 y 3 polos



Para más de 150 países



100-250V

Hz

50/60Hz

Adaptador universal PRO

Diseñado en Suiza. Para dispositivos de 2 y 3 polos. Compatible **entrada:** Europa (Sucko y 2 Euro)
Compatible **salida:** Suiza, Italia, Brasil, UK, EE.UU, Australia, China. **Potencia:** 630W (100V) / 1575W (250V).
Válido para más de 120 países. No convierte el voltaje.

Referencia	Potencia	Amperios	Dimensión	Embalaje
000203397	Máx. 1575W	Máx. 6.3A	72x55x58mm	20

*Consulta los países compatibles en el apartado info técnica.

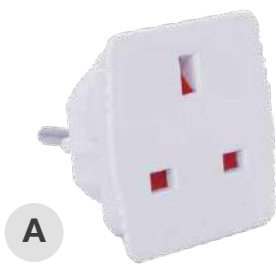

Adaptadores de viaje



CHILD



250V

Hz

50Hz

Clavija europea con espiga de Ø4.8mm. Protección para niños/as. Ideal para viajes.

Referencia	Artículo	Tipo	Potencia	Amperios	Embalaje
000200598	A	Europeo - Inglés	Máx. 3500W	10/16A	10/500
103005000	B	Europeo - Universal	Máx. 2500W	10A	270
000203995	C	Inglés - Europeo	Máx. 2300W	10/16A	10/200



A



B



C

Ladrones sin interruptor



CHILD



250V



50Hz

Material: **PP**. Con protección para niños/as.

Referencia	Artículo	Tipo	Potencia	Amperios	Embalaje
103000013	A	Doble Plano	Máx. 2300W	10A	10/100
000203365	B	Doble	Máx. 3680W	16A	10/100
000203366	C	Triple	Máx. 3680W	1x16A/2x10A	10/100



A



B



C



CHILD



220-240V



50/60Hz

Ladrones sin interruptor

2P con TT lateral.

Nuevo embalaje **respetuoso con el medio ambiente.**

Referencia	Artículo	Tipo	Potencia	Velocidad	Amperios	Embalaje
103000019	A	Doble salida	Máx. 3680W	-	16A	40
103000020	B	Simple + USB A + USB C	Máx. 3680W	5V / 3A	16A	40
103000021	C	Cuádruple	Máx. 3680W	-	16A	40



D



E



Ladrones sin interruptor



CHILD



250V



50Hz

Material: **PP**. 2P con TT lateral. Con protección para niños/as.
Nuevo embalaje **respetuoso con el medio ambiente**.

Referencia	Artículo	Tipo	Potencia	Color	Amperios	Embalaje
103000002	D	Doble	Máx. 3680W	○ Blanco	16A	10/100
103000024 ★	D	Doble	Máx. 3680W	● Negro	16A	10/100
103000003	E	Triple	Máx. 3680W	○ Blanco	16A	10/100
103000025 ★	E	Triple	Máx. 3680W	● Negro	16A	10/100



Ladrones con interruptor



CHILD



250V



50Hz

Material: **PP**. 2P con TT lateral. Con protección para niños/as.
 Nuevo embalaje **respetuoso con el medio ambiente**.

Referencia	Artículo	Tipo	Potencia	Color	Amperios	Embalaje
103000000	A	Simple	Máx. 3680W	○ Blanco	16A	10/100
103000026 ★	A	Simple	Máx. 3680W	● Negro	16A	10/100
103000001	B	Doble	Máx. 3680W	○ Blanco	16A	10/100
103000027 ★	B	Doble	Máx. 3680W	● Negro	16A	10/100
103000004	C	Triple	Máx. 3680W	○ Blanco	16A	10/50
103000028 ★	C	Triple	Máx. 3680W	● Negro	16A	10/50



CHILD



220-240V



50/60Hz

Ladrón triple salida con multi interruptor

Con interruptor **individual**. Material: **PP**. Sucko 2P con TT lateral.
Con protección para niños/as. Nuevo embalaje **respetuoso con el medio ambiente**.

Referencia	Tipo	Potencia	Color	Amperios	Embalaje
103000032	Triple	Máx. 3680W	○ Blanco	16A	5/50



230V



50Hz

Ladrón alargador triple salida con 2 USB

Incluye **2 tomas de carga por USB de 2.4A 5V/DC** cada uno. Sucko: 16A.
Cable: H05VV-F 3G. Ideal para cargar smartphones, MP3, MP4, tablets,...
Con protección para niños/as. Sucko 2P con TT lateral. Longitud del cable: **1.4M**.

Referencia	Potencia	Dimensión	Embalaje
103000014	Máx. 3680W	49x92x77mm	20



250V



50Hz

Ladrón base USB y tipo C

Velocidad de carga **USB y tipo C 5V/DC**. Amperios totales **3.4A**.

El **chip controla y regula automáticamente** los amperios que necesite el dispositivo.

Ideal para cargar smartphones, MP3, MP4, tablets... Con protección para niños/as. Sucko 2P con TT lateral.

Referencia	Potencia	Carga por puerto	Dimensión	Embalaje
103000018	Máx. 3680W	18W	52x74x101mm	10/50



110-240V



50/60Hz

Ladrón base USB C + A

Velocidad de carga (Output **USB A**): 5V / 2.4A / Máx.12W.

Velocidad de carga (Output **USB C**): 5V / 2.4A / Máx.12W.

Velocidad de carga (Output **USB A + C**): 5V / 2.4A / Máx.12W (En total).

Material: **PP**. Ideal para cargar smartphones, MP3, MP4, tablets...

Sucko 2P con TT lateral. Con protección para niños/as.

Referencia	Potencia	Carga por puerto	Dimensión	Embalaje
103000031	Máx. 3680W	12W	50x75x94mm	10/100



CHILD



250V



50Hz

Ladrón doble salida

Sucko 2P con TT lateral. Con protección para niños/as.
Nuevo embalaje **respetuoso con el medio ambiente.**

Referencia	Tipo	Potencia	Color	Amperios	Embalaje
103000005	Doble	Máx. 3680W	○ Blanco	16A	10/100
103000029 ★	Doble	Máx. 3680W	● Negro	16A	10/100



CHILD



250V



50Hz

Ladrón triple salida

Sucko 2P con TT lateral.
Nuevo embalaje **respetuoso con el medio ambiente.**

Referencia	Tipo	Potencia	Color	Amperios	Embalaje
103000006	Triple	Máx. 3680W	○ Blanco	16A	10/100



CHILD



250V



50Hz

Ladrón triple salida

Sucko 2P con TT lateral.
Nuevo embalaje **respetuoso con el medio ambiente.**

Referencia	Tipo	Potencia	Color	Amperios	Embalaje
103000030	Triple	Máx. 3680W	● Negro	16A	10/100



CHILD



250V



50Hz

Ladrón triple salida con interruptor

Sucko 2P con TT lateral. Material: **policarbonato.**

Referencia	Tipo	Potencia	Amperios	Embalaje
000200717	Triple	Máx. 3500W	10/16A	10/100



Ladrón triple salida



CHILD



250V



50Hz

Material: **policarbonato**. Termoplástico **auto extinguable**.

Referencia	Tipo	Potencia	Espiga	Amperios	Embalaje
103000015	Triple	Máx. 2300W	Ø4mm	10A	250

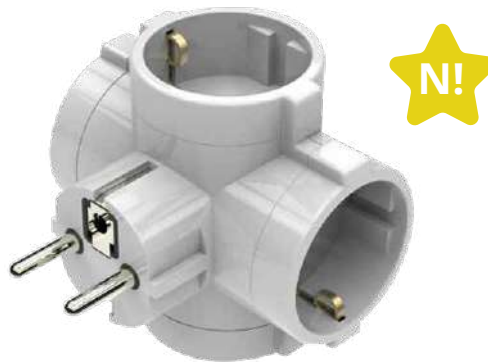

Ladrón cuatro salidas



CHILD



250V



50Hz

Sucko 2P con TT lateral. Material: **policarbonato**.

Referencia	Tipo	Potencia	Amperios	Embalaje
103000023	Cuádruple	Máx. 3680W	16A	10/100



Mecanismos

Material eléctrico





CHILD



250V



50Hz

Bases superficie

Con TT lateral. Bloque **interior cerámico**.

Referencia	Tipo	Amperios	Dimensión	Embalaje
000200250	Redonda	10/16A	Ø50x45mm	12/240



CHILD



250V



50Hz

Bases superficie

Con TT lateral. Bloque **interior cerámico**.

Referencia	Tipo	Amperios	Dimensión	Embalaje
000200251	Cuadrada	10/16A	60x60x45mm	12/192



LG-Alpha

SERIE



A Interrupcion



B Conmutador



C Doble interrupcion



250V

Hz

50Hz

Interrupciones & conmutadores de superficie

Material: policarbonato. Bloque interior cerámico.

Referencia	Artículo	Tipo	Amperios	Dimensión	Embalaje
000201023	A	Interrupcion	10A	60x60x30mm	10/200
000201024	B	Conmutador	10A	60x60x30mm	10/200
000201027	C	Doble interrupcion	10A	60x60x30mm	10/200



D Pulsador campana



E Pulsador luz



F Base sucko



CHILD



250V

Hz

50Hz

Pulsador & Base sucko de superficie

Material: policarbonato.

Referencia	Artículo	Tipo	Amperios	Dimensión	Embalaje
000201025	D	Pulsador campana	10A	60x60x30mm	10/200
000201026	E	Pulsador luz	10A	60x60x30mm	10/200
000201028	F	Base sucko	10A	60x60x45mm	10/200



LG-Focus

SERIE

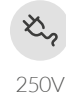

Interruptores & conmutadores de superficie

Material: policarbonato.

Referencia	Artículo	Tipo	Amperios	Dimensión	Embalaje
000200490	A	Interruptor	10A	80x80x30mm	20/100
000200491	B	Conmutador	10A	80x80x30mm	20/100
000200492	C	Interruptor doble polo	10A	80x80x30mm	20/100

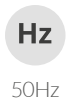

Doble interruptor de superficie

Material: policarbonato.

Referencia	Tipo	Amperios	Dimensión	Embalaje
000200496	Doble interruptor	10A	80x80x30mm	20/100



A Pulsador campana



B Pulsador luz



250V

Hz

50Hz

Pulsador de superficie

Material: policarbonato.

Referencia	Artículo	Tipo	Amperios	Dimensión	Embalaje
000200493	A	Pulsador campana	10A	80x80x30mm	20/100
000200494	B	Pulsador luz	10A	80x80x30mm	20/100



C Sucko



D Sin pozo



250V

Hz

50Hz

Bases de superficie

Material: policarbonato.

Referencia	Artículo	Tipo	TT lateral	Amperios	Dimensión	Embalaje
000200498	C	Sucko	Sí	16A	80x80x41mm	10/100
000200499	D	Sin pozo	No	16A	80x80x28mm	20/100





Base TV y FM de superficie

A

16A

⚡

250V

Material: **policarbonato**. Con toma de TV y FM. Ø9.5mm.

Referencia

Dimensión

Embalaje

000200500

80x80x28mm

20/100



Base teléfono de superficie

A

16A

⚡

250V

Material: **policarbonato**. Con toma de teléfono 6p4c-RJ11.

Referencia

Dimensión

Embalaje

000200501

80x80x28mm

20/100





IP20



230V



50/60Hz

Regulador de lámparas LED

Se utiliza con pulsadores. **Convierte tus pulsadores en reguladores de intensidad.**

En lámparas incandescentes, halógenas, halógenas con transformador regulable, halógenas con transformador electrónico: 20-150W.

Lámparas LED regulables: 4-40W. **Nivel mínimo de intensidad regulable. Regulación al final de fase.**

Tamaño reducido, ideal para instalación en cualquier lugar. Protección **sobrecalentamiento** y **sobrecarga**.

Referencia	Potencia	Material	Dimensión	Embalaje
103500024	Máx. 150W	Policarbonato	40x50x16mm	100



IP20



220-240V



50Hz

Regulador de lámparas LED

Sin cable neutro.

Bombillas **incandescentes** regulables: 5-250W. Bombillas **halógenas** regulables: 5-300W.

Lámparas **LED** regulables: 5-250W. Tamaño reducido, ideal para instalación en cualquier lugar.

Referencia	Potencia LED	Modo atenuación	Dimensión	Embalaje
103500038	5-250W	Trailing Edge	42.7x11.5x45.5mm	200



Iota

SERIE



250V



50Hz

Interruptores & conmutadores empotrables

Material: **policarbonato**. Color: **blanco**.

Referencia	Artículo	Tipo	Amperios	Dimensión	Embalaje
103500000	A	Interruptor	10A	56x56mm	10/100
103500002	B	Conmutador	10A	56x56mm	10/100
103500004	C	Interruptor cruzamiento	10A	56x56mm	10/100

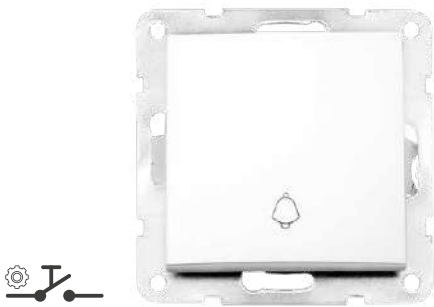

Pulsador campana empotrable

A

10A



250V

Material: **policarbonato**. Color: **blanco**.

Referencia	Dimensión	Embalaje
103500006	56x56mm	10/100

Doble conmutador empotrable

A

10A



250V

Material: **policarbonato**. Color: **blanco**.

Referencia	Dimensión	Embalaje
103500008	56x56mm	10/100



Base enchufe sucko empotrable

A 16A 250V

Material: **policarbonato**. Color: **blanco**. Con 2P + TT lateral. Con protección para niños.

Referencia	Dimensión	Embalaje
103500010	56x56mm	10/100

Base de teléfono empotrable

A 16A 250V

Material: **policarbonato**. Color: **blanco**. Con toma de teléfono **6p4c-RJ11**. Cat 3. Con protección para niños.

Referencia	Dimensión	Embalaje
103500012	56x56mm	10/100



Base TV empotrable

A 16A 250V

Material: **policarbonato**. Color: **blanco**. Ø9.5mm. Con protección para niños.

Referencia	Dimensión	Embalaje
103500014	56x56mm	10/100

Base de datos empotrable

A 16A 250V

Material: **policarbonato**. Color: **blanco**. Con toma de teléfono **8p8c-RJ45**. Cat5E. Con protección para niños.

Referencia	Dimensión	Embalaje
103500016	56x56mm	10/100



Iota

SERIE



250V



50Hz

Interruptores & conmutadores empotrables

Material: **policarbonato**. Color: **plateado**.

Referencia	Artículo	Tipo	Amperios	Dimensión	Embalaje
103500001	A	Interruptor	10A	56x56mm	10/100
103500003	B	Conmutador	10A	56x56mm	10/100
103500005	C	Interruptor cruzamiento	10A	56x56mm	10/100



Pulsador campana empotrable



10A



250V

Material: **policarbonato**. Color: **plateado**.

Referencia	Dimensión	Embalaje
103500007	56x56mm	10/100

Doble conmutador empotrable



10A



250V

Material: **policarbonato**. Color: **plateado**.

Referencia	Dimensión	Embalaje
103500009	56x56mm	10/100

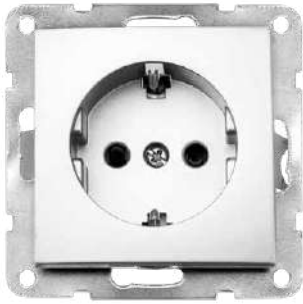

Base enchufe sucko empotrable

A 
16A 250V

Material: **policarbonato**. Color: **plateado**. Con 2P + TT lateral. Con protección para niños.

Referencia	Dimensión	Embalaje
103500011	56x56mm	10/100

Base de teléfono empotrable

A 
16A 250V

Material: **policarbonato**. Color: **plateado**. Con toma de teléfono **6p4c-RJ11**. Cat 3. Con protección para niños.

Referencia	Dimensión	Embalaje
103500013	56x56mm	10/100



Base TV empotrable

A 
16A 250V

Material: **policarbonato**. Color: **plateado**. Ø9.5mm. Con protección para niños.

Referencia	Dimensión	Embalaje
103500015	56x56mm	10/100

Base de datos empotrable

A 
16A 250V

Material: **policarbonato**. Color: **plateado**. Con toma de teléfono **8p8c-RJ45**. Cat6. Con protección para niños.

Referencia	Dimensión	Embalaje
103500017	56x56mm	10/100

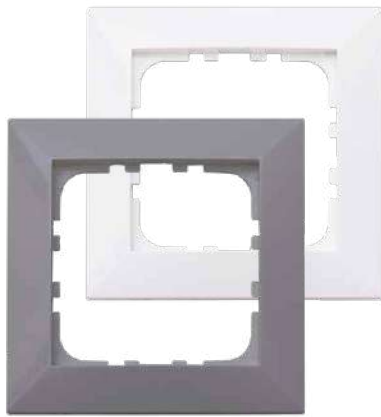

A

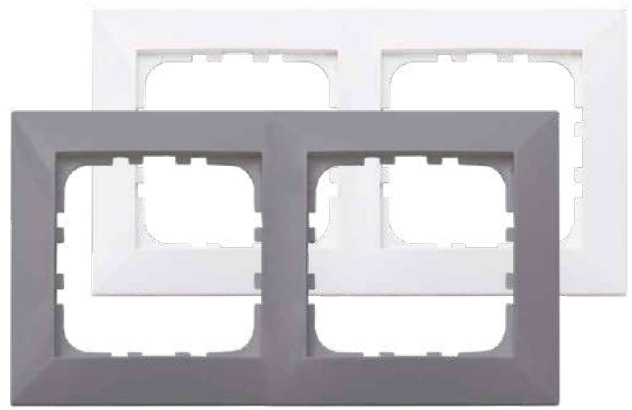

B

Embellecedores

Material: **policarbonato**. Para serie **lota**.

Referencia	Artículo	Tipo	Color	Para	Dimensión	Embalaje
103500018	A	Simple	○ Blanco	1 módulo	82x82mm	100
103500019	A	Simple	● Plata mate	1 módulo	82x82mm	100
103500020	B	Doble	○ Blanco	2 módulos	154x82mm	100
103500021	B	Doble	● Plata mate	2 módulos	154x82mm	100

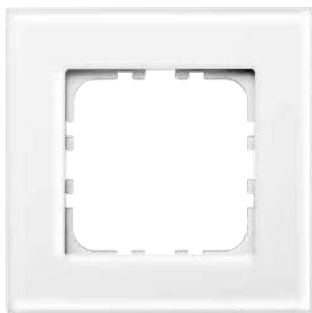

C

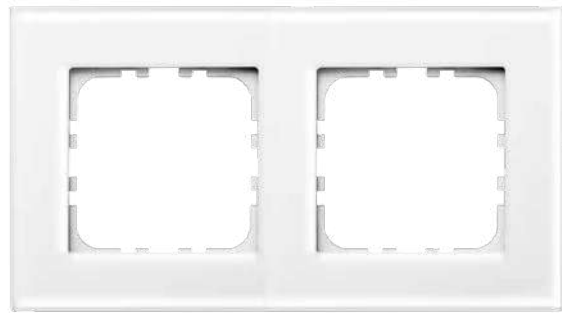

D

Embellecedores **crystal**

Material: **crystal**. Para serie **lota**.

Referencia	Artículo	Tipo	Color	Para	Dimensión	Embalaje
103500022	C	Simple	○ Blanco	1 módulo	82x82mm	100
103500023	D	Doble	○ Blanco	2 módulos	154x82mm	100



Gamma

SERIE



A Interruptor



B Conmutador



C Interr. cruzamiento



250V

Hz

50Hz

Interruptores & conmutadores empotrables

Material: **policarbonato**.

Referencia	Artículo	Tipo	Amperios	Dimensión	Embalaje
000201000	A	Interruptor	10A	56x56mm	10/100
000201001	B	Conmutador	10A	56x56mm	10/100
000201002	C	Interruptor cruzamiento	10A	56x56mm	10/100



D Pulsador



250V

Hz

50Hz

Pulsadores empotrables

Material: **policarbonato**.

Referencia	Artículo	Tipo	Amperios	Dimensión	Embalaje
103500036	D	Pulsador	10A	56x56mm	10/100

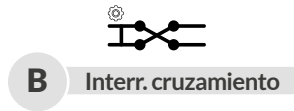

Interruptores & conmutadores empotrables + LED

Con indicador LED. Material: **policarbonato**.

Referencia	Artículo	Tipo	Amperios	Dimensión	Embalaje
000201007	A	Conmutador	10A	56x56mm	10/100
000201008	B	Interruptor cruzamiento	10A	56x56mm	10/100



Pulsador empotrable + LED

Con indicador LED. Material: **policarbonato**.

Referencia	Artículo	Tipo	Amperios	Dimensión	Embalaje
103500037	C	Pulsador	10A	56x56mm	10/100



Doble conmutador empotrable

A
10A 250V

Material: **policarbonato**.

Referencia	Dimensión	Embalaje
000201005	56x56mm	10/100



Regulador de luz empotrable

A
10A 250V

Material: **policarbonato**.
Función por **giro manual**. Con protección para niños.

Referencia	Potencia	Fusible	Dimensión	Embalaje
000201011	60-300W	1.5A	56x56mm	8/80



A



B

Bases enchufe empotrables

CHILD 250V 50Hz

Material: **policarbonato**. Con protección para niños.

Referencia	Artículo	Tipo	TT lateral	Amperios	Dimensión	Embalaje
000201012	A	Sin pozo	No	16A	56x56mm	10/100
000201013	B	Sucko	Sí	16A	56x56mm	10/100



A



B



C

Bases empotrables



CHILD



250V



Hz

50Hz

Material: **policarbonato**.

Referencia	Artículo	Tipo	Conexión	Amperios	Dimensión	Embalaje
000201014	A	Base de teléfono	RJ11-6C4P	16A	56x56mm	10/100
000201015	B	Base de TV y FM	Ø9.5mm	16A	56x56mm	10/100
000201016	C	Base teléfono e internet	RJ11-RJ45	16A	56x56mm	10/100



Tapa salida de cable empotrable

A

10A



250V

Material: **policarbonato**.

Referencia	Dimensión	Embalaje
000201017	56x56mm	20/200

Tapa ciega empotrable

Material: **policarbonato**.

Referencia	Dimensión	Embalaje
000201018	56x56mm	20/200

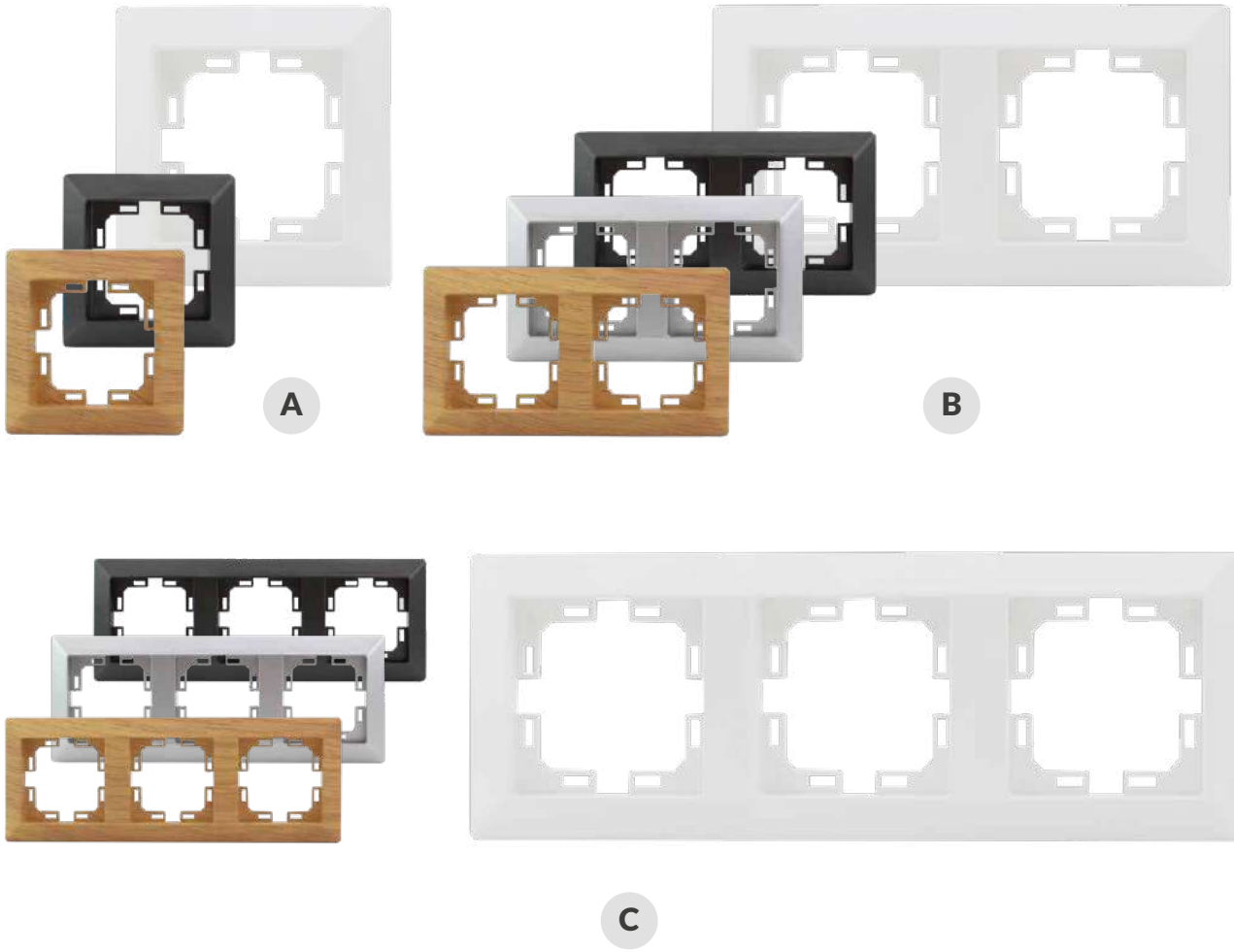

Embellecedores

Material: **poli carbonato**. Para serie **Gamma**.

Referencia	Artículo	Tipo	Color	Para	Dimensión	Embalaje
000201019	A	Simple	○ Blanco	1 módulo	82x82mm	42/420
000201032	A	Simple	● Gris antracita	1 módulo	82x82mm	42/420
000201034	A	Simple	● Madera	1 módulo	82x82mm	42/420
000201020	B	Doble	○ Blanco	2 módulos	154x82mm	22/220
000201035	B	Doble	● Gris antracita	2 módulos	154x82mm	22/220
000201036	B	Doble	● Plata mate	2 módulos	154x82mm	22/220
000201037	B	Doble	● Madera	2 módulos	154x82mm	22/220
000201021	C	Triple	○ Blanco	3 módulos	226x82mm	14/140
000201038	C	Triple	● Gris antracita	3 módulos	226x82mm	14/140
000201039	C	Triple	● Plata mate	3 módulos	226x82mm	14/140
000201040	C	Triple	● Madera	3 módulos	226x82mm	14/140



A

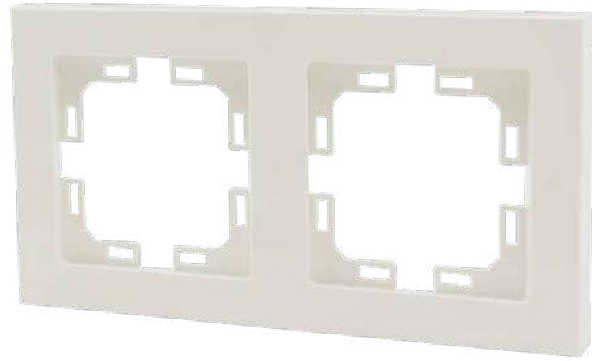

B

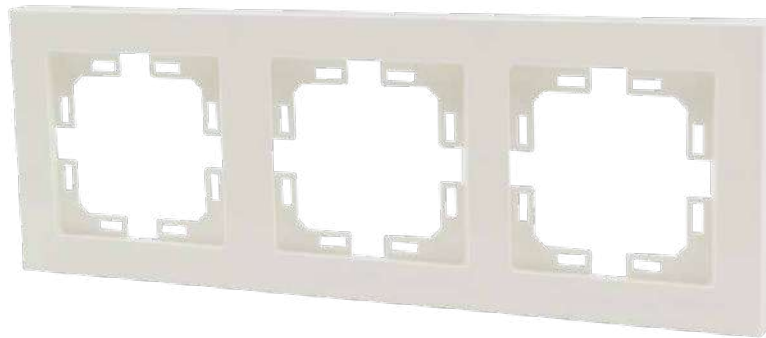

C

Embellecedores rectos

Material: **policarbonato**. Para serie **Gamma**.

Referencia	Artículo	Tipo	Color	Para	Dimensión	Embalaje
000201041	A	Simple	○ Blanco	1 módulo	82x82mm	42/420
000201042	B	Doble	○ Blanco	2 módulos	154x82mm	22/220
000201043	C	Triple	○ Blanco	3 módulos	226x82mm	14/140

Estanca

SERIE



A Interruptor



B Conmutador



IP54



250V



50Hz

Interruptores & conmutadores estancos

Uso exterior.

Referencia	Artículo	Tipo	Amperios	Dimensión	Embalaje
001200252	A	Interruptor	10A	70x70x50mm	10/100
001200253	B	Conmutador	10A	70x70x50mm	10/100



Pulsador campana estanco



IP54



250V

Uso exterior. 10A. 50Hz

Referencia	Dimensión	Embalaje
001200254	70x70x50mm	10/100



Doble conmutador estanco



IP54



250V

Uso exterior. 10A. 50Hz

Referencia	Dimensión	Embalaje
001200502	70x70x50mm	10/100



Interruptores & conmutadores estancos + LED



Con indicador LED. Uso exterior.

Referencia	Artículo	Tipo	Amperios	Dimensión	Embalaje
001200866	A	Interruptor	10A	70x70x50mm	10/100
001200867	B	Conmutador	10A	70x70x50mm	10/100



Pulsador campana estanco + LED



Con indicador LED. Uso exterior.

Referencia	Tipo	Amperios	Dimensión	Embalaje
001200868	Pulsador campana	10A	70x70x50mm	10/100



A



B



CHILD



IP44



250V



50Hz

Base sucko estanca con tapa

Uso exterior.

Referencia	Artículo	Tipo	Amperios	Dimensión	Embalaje
001200256	A	Simple	16A	70x70x50mm	10/100
001200257	B	Doble	16A	140x70x50mm	5/50



CHILD



IP44



250V



50Hz

Conmutador + base estanca

Base con tapa. Uso exterior.

Referencia	Tipo	Amperios	Dimensión	Embalaje
001200255	Conmutador + Base	16A	140x70x50mm	5/50



Estanca

SERIE



Interruptor / Conmutador / Pulsador estanco

Uso exterior.

Referencia	Artículo	Tipo	Amperios	Dimensión	Embalaje
001203747	A	Interruptor	16A	66x82x65mm	10/100
001203748	B	Conmutador	16A	66x82x65mm	10/100
001203749	C	Pulsador	10A	66x82x65mm	10/100



Pulsador LED estanco



Con indicador LED. Uso exterior. 10A. 50Hz

Referencia	Dimensión	Embalaje
001203750	66x82x65mm	10/100

Doble conmutador estanco



Uso exterior. 16A. 50Hz

Referencia	Dimensión	Embalaje
001203751	66x82x65mm	10/100



Base enchufe **sucko**



IP55



250V



50Hz

Uso exterior.

Referencia	Amperios	Dimensión	Embalaje
001203752	16A	66x82x65mm	10/100



Conmutador + base enchufe **sucko**



IP55



250V



50Hz

Uso exterior.

Referencia	Amperios	Dimensión	Embalaje
001203753	16A	99x82x65mm	10/100



A



B



C



IP55

Cajas superficie con tapa

Uso exterior.

Referencia	Artículo	Tipo	Dimensión	Embalaje
001203763	A	1 módulo	65.5x82.5x63mm	10/100
001203764	B	2 módulos	65.5x82.5x63mm	10/100
001203765	C	3 módulos	99.2x82.5x63mm	10/100



D



Interruptor



E



Conmutador



F

Pulsador campana



250V

Hz

50Hz

Módulo Interruptor / Conmutador / Pulsador

Uso exterior.

Referencia	Artículo	Tipo	Amperios	Dimensión	Embalaje
001203755	D	Interruptor	16A	22x38x45mm	80/800
001203756	E	Conmutador	16A	22x38x45mm	80/800
001203757	F	Pulsador campana	10A	22x38x45mm	80/800



A Placa ciega



B Base sucko



C Toma TV



D Teléfono



E Internet



F Toma USB

Módulos para cajas estancas

110-240V 50Hz

Módulos para cajas de superficie con tapa.

Referencia	Artículo	Tipo	Conexión	Módulo	Embalaje
001203758	A	Módulo placa ciega	-	Estrecho	200/2000
001203759	B	Módulo base sucko	TT lateral	Ancho	48/480
001203760	C	Módulo toma TV	Toma Ø9.5mm	Ancho	40/400
001203761	D	Módulo teléfono	RJ11-6P4C	Estrecho	80/800
001203762	E	Módulo internet	RJ45-8P8C Cat6	Estrecho	80/800
001200266	F	Módulo toma USB	USB 2.4A / 5V	Estrecho	80/800



Timbres

Material eléctrico

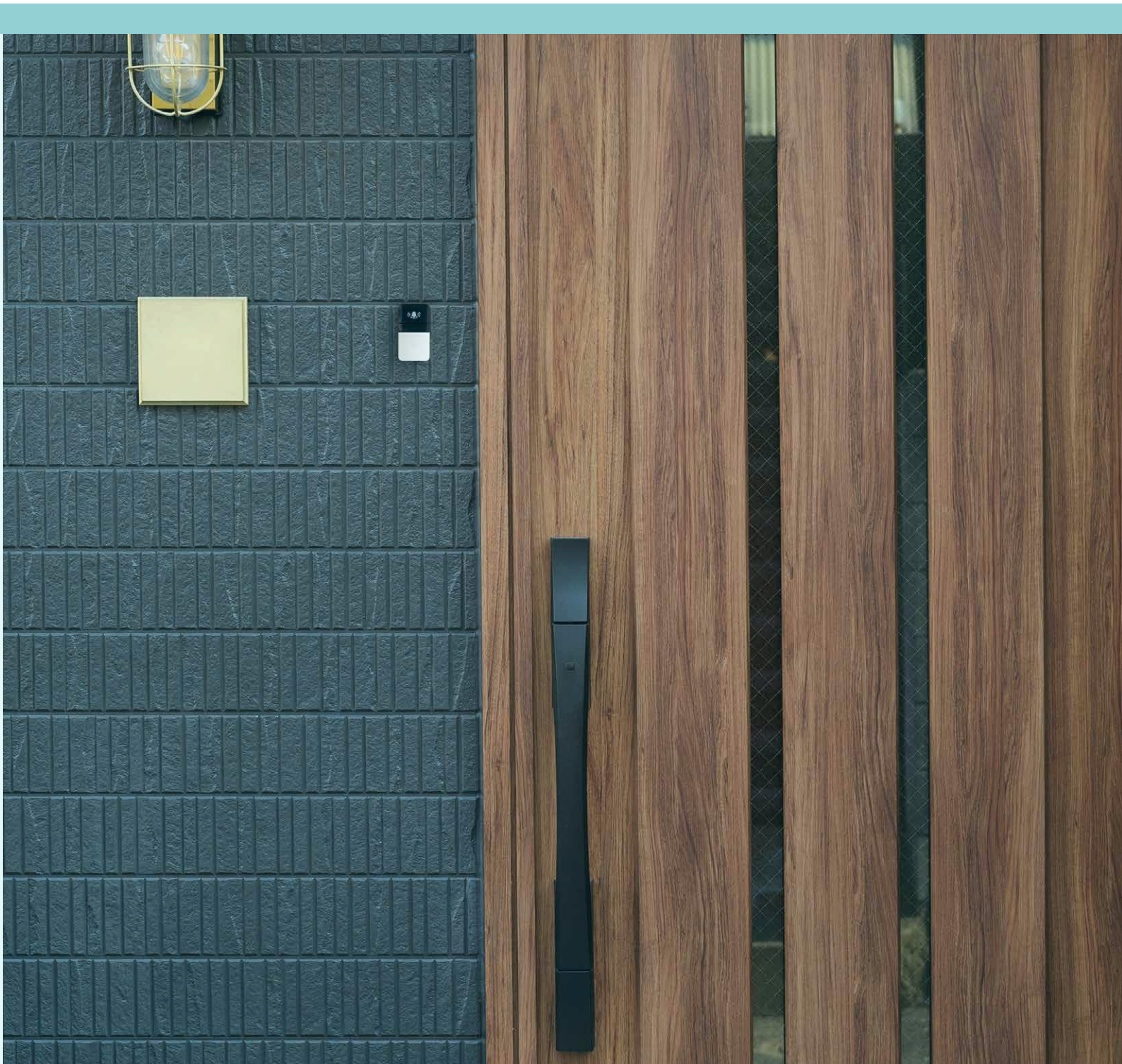

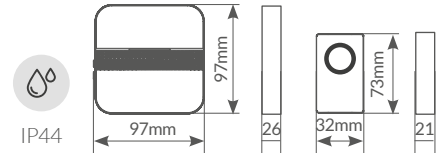

Timbre inalámbrico

Hasta 30 sonidos diferentes. Distancia emisor/receptor: 100M.

Timbre/Receptor. Volumen regulable. Funciona a 220-240V.

Pulsador/Emisor. Alimentado a pilas. 1 x CR2032 (3V).

Con indicador LED que parpadea cuando suena. **Frecuencia:** 433.92MHz.

Función autoaprendizaje (se pueden conectar hasta 10 pulsadores a la vez). **Decibelios:** 85dB.

Material: **ABS.** Pulsador con **montaje a tornillos** (incluidos) o con **cinta adhesiva 3M** (incluida). Blíster.

Referencia	Melodías	Volumen	Embalaje
104000003	30	Regulable	10/40

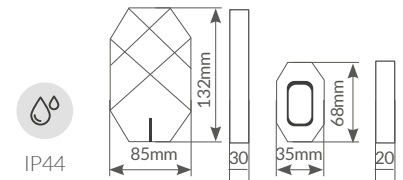

Timbre inalámbrico con sensor táctil

Hasta 30 sonidos diferentes. Distancia emisor/receptor: 100M.

Timbre/Receptor. Volumen regulable con **3 niveles.** Alimentado a pilas. Utiliza 3 x AA.

Pulsador/Emisor. Alimentado con una pila CR2032 (incluida). Con indicador LED.

Frecuencia: 433.92MHz. **Función autoaprendizaje** (se pueden conectar hasta 10 pulsadores y 10 timbres a la vez).

Decibelios: 85dB. Material: **ABS.** Timbre con **montaje a tornillos** (incluidos). Pulsador con **cinta adhesiva 3M.** Blíster.

Referencia	Melodías	Volumen	Embalaje
104000001	30	3 niveles	10/60
104000006 ★	Pulsador para timbre inalámbrico ref. 104000001		



IP44

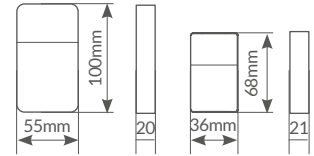

Timbre inalámbrico **kinético**

Hasta 16 sonidos diferentes. Distancia emisor/receptor: 100M.

Timbre/Receptor. Volumen regulable con 4 niveles. Funciona a 220-240V.

Pulsador/Emisor: kinético, **no necesita pilas.** Con indicador LED. **Frecuencia:** 433.92MHz.

Función autoaprendizaje (se pueden conectar hasta 10 pulsadores y 10 timbres a la vez). **Decibelios:** 85dB.

Material: ABS. Pulsador con **montaje a tornillos** (incluidos) o con **cinta adhesiva 3M.** Blíster.

Referencia	Melodías	Volumen	Embalaje
10400002	16	4 niveles	10/40
10400007 ★	Pulsador para timbre inalámbrico ref. 10400002		



IP44

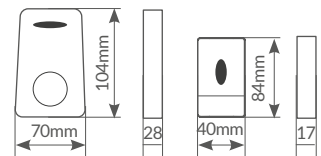

Timbre inalámbrico

Hasta 36 sonidos diferentes. Distancia emisor/receptor: 80M.

Timbre/Receptor. Volumen regulable. Alimentado a pilas. 3 x AA.

Pulsador/Emisor. Alimentado a pilas. 1 x 23A (12V). Con indicador LED. **Frecuencia:** 433.92MHz/315MHz.

Función autoaprendizaje (se pueden conectar varios pulsadores a la vez). **Decibelios:** 60-85dB. Blíster.

Referencia	Melodías	Volumen	Embalaje
001403690	36	4 niveles	12/48



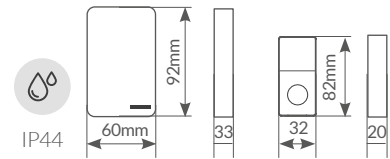

Timbre inalámbrico con sensor apertura

Hasta 38 sonidos diferentes. Distancia emisor/receptor: 150M.

Timbre/Receptor: Volumen regulable. 230V. **Pulsador/Emisor:** alimentado a pilas. 1 x CR2032(3V).

Emisor de señal apertura: alimentado a pilas. 1 x CR2032(3V). Pilas incluidas. **Frecuencia:** 433.92MHz.

Función autoaprendizaje (se pueden conectar varios pulsadores a la vez). **Decibelios:** 85dB.

Acepta hasta **16 emisores de señal** de apertura. El emisor de señal de apertura es **ideal para colocar en puertas y/o ventanas**.

Anclaje: **adhesivo o tornillo**. Blíster.

Referencia	Melodías	Volumen	Embalaje
001403693	38	3 niveles	12/48

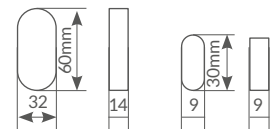

Emisores señal de apertura

Distancia emisor/receptor: 100M.

Emisor de señal apertura: alimentado a pilas. 1 x CR2032(3V). Pilas incluidas. **Frecuencia:** 433.92MHz.

Decibelios: 85dB. El emisor de señal de apertura es **ideal para colocar en puertas y/o ventanas**.

Anclaje: **adhesivo o tornillo**. Blíster.

Referencia	Para referencia	Embalaje
001403694	001403693	12/48

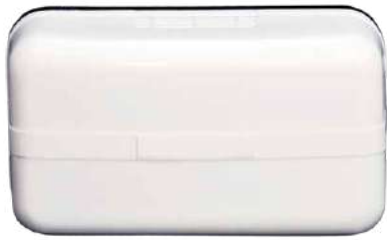

A



B



C



230V

Timbre Ding-Dong

Con fusible de protección para cortocircuitos. Blíster.

Referencia	Artículo	Decibelios	Dimensión	Embalaje
001400264	A	80dB	135x79x50mm	10/60
001400265	B	80dB	116x116x48mm	6/48
001400266	C	80dB	170x105x49mm	12/24



220-240V

Zumbador

Blíster.

Referencia	Decibelios	Dimensión	Embalaje
001400263	80dB	57x40x29mm	10/100



A

12V 230V



B

12V 230V

Timbre campana industrial

Tipo: **electromecánico**. Gran sonoridad para uso industrial interior. Para montar en superficie.

Referencia	Artículo	Decibelios	Diámetro	Corriente	Peso	Embalaje
001400967	A	86dB	Ø100mm	230V AC	350gr.	50
001403815	A	86dB	Ø100mm	12V DC	350gr.	50
001400968	B	90dB	Ø150mm	230V AC	900gr.	20
001403816	B	90dB	Ø150mm	12V DC	900gr.	20



Timbre campana circular 230V

Material: **acero**. Gran sonoridad para usos industriales. Para montar en superficie. Peso 350gr.

Referencia	Decibelios	Diámetro	Embalaje
001403817	86dB	Ø75mm	100
001400969	86dB	Ø100mm	50



Timbre campana eléctrico 230V

Con martillo. Gran sonoridad para usos industriales. Para montar en superficie.

Referencia	Decibelios	Diámetro	Embalaje
001400970	87dB	Ø100mm	30



Detectores y alarmas

Material eléctrico





- 60° V / 180° H
- 1.8-2.5M
- 55x80x68mm
- IP44
- 220-240V

Detector superficie pared

Tiempo regulable: 10seg. a 15min. **Máx. radio detección:** 12M.
Luz ambiental: 3-2000lux (regulable). **Consumo stand-by:** 0.45W.
Temperatura de funcionamiento: -20°C+40°C.

Referencia	Potencia máx.	Color	Tipo	Regulable	Embalaje
001400148	800W / Incand. 400W / B. Consumo & LED	○ Blanco	Movimiento	Tiempo / Luz	50
001400149	800W / Incand. 400W / B. Consumo & LED	● Negro	Movimiento	Tiempo / Luz	50



- 360°
- 1.8-2.5M
- 60x119x79mm
- IP44
- 220-240V

Detector superficie esquinero y pared

Tiempo regulable: 10seg. ± 3seg. a 15min ± 2min. **Máx. radio detección:** 12M (regulable).
Luz ambiental: 3-2000lux (regulable), <15Lux (función fotocélula). **Área detección:** 360° (regulable).
Consumo stand-by: 0.45W. **Temperatura de funcionamiento:** -20°C+40°C.

Referencia	Potencia máx.	Tipo	Regulable	Embalaje
001403388	1200W / Incand. 300W / B. Consumo & LED	Movimiento	Tiempo / Luz	50



Detector superficie esquinero y pared



240°



1.8-2.5M



125.2x72.7x71.4mm



IP65



220-240V

Tiempo regulable: 10seg. ± 3seg. a 15min ± 2min. **Máx. radio detección:** 10M.
Luz ambiental: <3-2000lux (regulable), <15Lux (función fotocélula).
Consumo stand-by: 0.5W. **Temperatura de funcionamiento:** -20°C+40°C.

Referencia	Potencia máx.	Tipo	Regulable	Embalaje
104310004	1200W / Incand. 600W / B. Consumo & LED	Movimiento	Tiempo / Luz	50



Detector superficie orientable



180°



1.8-2.5M



80x119x51mm



IP65



220-240V

Orientable: arriba, abajo, derecha e izquierda.
Tiempo regulable: 10seg. ± 3seg. a 15min ± 3min. **Máx. radio detección:** 12M (<24°C).
Luz ambiental: 3-2000lux (regulable). **Consumo stand-by:** 0.45W.
Temperatura de funcionamiento: -20°C+40°C.

Referencia	Potencia máx.	Tipo	Regulable	Embalaje
001401391	1200W / Incand. 300W / B. Consumo & LED	Movimiento	Tiempo / Luz	50



Detector superficie orientable con 2 sensores



180° / 360°



1.8-2.5M



80x119x51mm



IP65



220-240V

Orientable: arriba, abajo. **Tiempo regulable:** 10seg. ± 3seg. a 15min ± 2min.
Máx. radio detección: 12M / 180°; 6M / 360° (<24°C).
Luz ambiental: 3-2000lux (regulable). **Temperatura de funcionamiento:** -20°C+40°C.
Consumo stand-by: 0.45W. **Ideal para colocar sobre puertas.**

Referencia	Potencia máx.	Tipo	Regulable	Embalaje
001403361	1200W / Incand. 300W / B. Consumo & LED	Movimiento	Tiempo / Luz	50



Detector superficie en techo



360°



2.2-4M



Ø115x58mm



220-240V

Tiempo regulable: 10seg. a 7min.
Máx. distancia detección: 6M. **Luz ambiental:** 3-2000lux (regulable).
Consumo stand-by: 0.45W. **Temperatura de funcionamiento:** -20°C+40°C.
 Con **indicador LED de actividad verde.**

Referencia	Potencia máx.	Tipo	Regulable	Embalaje
001400972	1200W / Incand. 300W / B. Consumo & LED	Movimiento	Tiempo / Luz	50



360°



2.2-4M



Ø76x20.2mm



IP20



220-240V

Mini-detector superficie en techo

Tiempo regulable: 10seg. ± 3seg. a 15min ± 2min.

Máx. distancia detección: 8M. **Luz ambiental:** 3-2000lux (regulable).

Consumo stand-by: 0.45W. **Temperatura de funcionamiento:** -20°C+40°C.

Referencia	Potencia máx.	Tipo	Regulable	Embalaje
104310000	400W / Incand. 200W / B. Consumo & LED	Movimiento	Tiempo / Luz	100



360°



2.2-6M



Ø120x52mm



220-240V

Detector superficie en techo

Tiempo regulable: 10seg. ± 3seg. a 30min ± 2min.

Distancia detección: 3-20M (regulable). **Luz ambiental:** 3-2000lux (regulable).

Consumo stand-by: 0.45W. **Temperatura de funcionamiento:** -20°C+40°C.

Referencia	Potencia máx.	Tipo	Regulable	Embalaje
001403389	2000W / Incand. 1000W / B. Consumo & LED	Movimiento	Tiempo / Luz	50



360°



2.2-4M



Ø115x24mm



IP20



220-240V

Detector superficie en techo

Tiempo regulable: 10seg. ± 3seg. a 15min ± 2min.
Máx. distancia detección: 8M (<24°C). **Luz ambiental:** 3-2000lux (regulable).
Consumo stand-by: 0.45W. **Temperatura de funcionamiento:** -20°C+40°C.

Referencia	Potencia máx.	Tipo	Regulable	Embalaje
104310001	800W / Incand. 400W / B. Consumo & LED	Movimiento	Tiempo / Luz	50



360°



2.2-4M



Ø115x24mm



IP20



220-240V

Detector superficie en techo

Tiempo regulable: 10seg. ± 3seg. a 15min ± 2min.
Máx. distancia detección: 6M (<24°C). **Luz ambiental:** 3-2000lux (regulable).
Consumo stand-by: 0.45W. **Temperatura de funcionamiento:** -20°C+40°C.

Referencia	Potencia máx.	Tipo	Regulable	Embalaje
001401392	2000W / Incand. 1000W / B. Consumo & LED	Movimiento	Tiempo / Luz	50

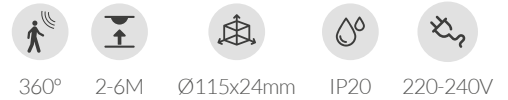

Detector superficie por microondas

Tiempo regulable: 10seg. ± 3seg. a 12min ± 1min.
Máx. radio detección: de 1M hasta 8M (<24°C). **Luz ambiental:** 3-2000lux (regulable).
Sistema HF: 5.8Gz. **Radar CW. Banda ISM. Consumo stand-by:** 0.45W.
Temperatura de funcionamiento: -20°C+40°C.

Referencia	Potencia máx.	Tipo	Regulable	Embalaje
001401393	2000W / Incand. 1000W / B. Consumo & LED	Movimiento	Tiempo / Luz	50

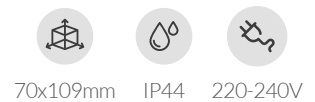

Detector superficie crepuscular y temporizador

Temporizador regulable: 1 a 9h. **Luz ambiental:** <3-500lux (regulable).
Consumo stand-by: 0.45W. **Temperatura de funcionamiento:** -20°C+40°C.

Referencia	Potencia máx.	Tipo	Regulable	Embalaje
104310003	2000W / Incand. 1000W / B. Consumo & LED	Crepuscular	Tiempo / Luz	50



Ø63x77mm



IP44



220-240V

Detector superficie crepuscular

Luz ambiental: 5-50lux (regulable).

Consumo stand-by: 0.45W. **Temperatura de funcionamiento:** -20°C+40°C.

Referencia	Potencia máx.	Tipo	Regulable	Embalaje
104310002	2000W / Incand. 1000W / B. Consumo & LED	Crepuscular	Luz	100



35x66x90mm



220-240V

Detector crepuscular montaje carril DIN

Luz ambiental: <2-100lux (regulable). Cable: 1M. **Consumo stand-by:** 0.45W.

Temperatura de funcionamiento: -20°C+40°C. **Módulo:** IP20. **Detector:** IP65.

Referencia	Potencia máx.	Tipo	Regulable	Embalaje
104305001	3000W / Incand. 1500W / B. Consumo & LED	Crepuscular	Luz	50



160°



1-1.8M



80x80x50mm



220-240V

Detector empotrar pared

Tiempo regulable: 10seg. a 7min. **Máx. radio detección:** 9M.

Luz ambiental: 3-2000lux (regulable). **Consumo stand-by:** 0.45W. Válido para montaje en caja universal.

Temperatura de funcionamiento: -20°C+40°C y bajo una humedad no superior al 93%.

Referencia	Potencia máx.	Tipo	Regulable	Embalaje
001400971	1200W / Incand. 300W / B. Consumo & LED	Movimiento	Tiempo / Luz	100



180°



1-1.8M



80x32x80mm



IP20



220-240V

Detector empotrar por microondas

Regulable: en tiempo / luz / sensibilidad. **Tiempo regulable:** 10seg. ± 3seg. a 12min ± 1min.

Máx. radio detección: de 5M hasta 15M (<24°C). **Luz ambiental:** 3-2000lux (regulable).

Sistema HF: 5.8Gz. **Radar CW. Banda ISM. Consumo stand-by:** 0.45W.

Empotramiento: 35x35mm. **Temperatura de funcionamiento:** -20°C+40°C.

Referencia	Potencia máx.	Tipo	Regulable	Embalaje
001401598	1200W / Incand. 1000W / B. Consumo & LED	Movimiento	Tiempo / Luz	100



360°



2.2-4M



Ø43x66.5mm



IP20



100-240V

Mini-detector empotrar en techo

Tiempo regulable: 10seg. ± 3seg. a 7min ± 2min.

Máx. distancia detección: 6M (<24°C). **Luz ambiental:** 3-2000lux (regulable).

Consumo stand-by: 0.45W. **Temperatura de funcionamiento:** -20°C+40°C.

Empotramiento: Ø33mm, profundidad 50mm.

Referencia	Potencia máx.	Tipo	Regulable	Embalaje
104305000	300W / Incand. 150W / B. Consumo & LED	Movimiento	Tiempo / Luz	100



360°



2.2-4M



Ø76x75mm



220-240V

Detector empotrar en techo

Tiempo regulable: 10seg. a 15min.

Máx. radio detección: 6M (<24°C). **Luz ambiental:** 3-2000lux (regulable).

Consumo stand-by: 0.45W. **Temperatura de funcionamiento:** -20°C+40°C.

Empotramiento: Ø65mm, profundidad 60mm.

Referencia	Potencia máx.	Tipo	Regulable	Embalaje
001401237	1200W / Incand. 300W / B. Consumo & LED	Movimiento	Tiempo / Luz	50



120°



1-1.8M



45x81.5x98.3mm



220-240V

Ladrón con detector de movimiento

Tiempo regulable: 10seg. a 7min. **Máx. distancia detección:** de 2M a 9M (regulable).

Luz ambiental: <3-2000lux (regulable). **Consumo stand-by:** 0.45W.

Temperatura de funcionamiento: -20°C+40°C.

Referencia	Potencia máx.	Tipo	Regulable	Embalaje
001401599	1200W / Incand. 300W / B. Consumo & LED	Movimiento	Tiempo / Luz	50



120° / 360°



1.8-2.5M



2-4M



55x37x25mm



220-240V

Detector empotrar en techo o luminarias

Tiempo regulable: 5seg., 30 seg., 1min., 3min., 5min. y 8min.

Máx. radio detección: 3M (<24°C). **Luz ambiental:** 10-2000lux (regulable).

Consumo stand-by: 0.45W. **Temperatura de funcionamiento:** -20°C+40°C.

Ideal para empotrar en techo o dentro de luminarias (espejos, apliques, etc.).

Referencia	Potencia máx.	Tipo	Regulable	Embalaje
001401339	800W / Incand. 200W / B. Consumo & LED	Movimiento	Tiempo / Luz	100



A

10A 56.8x37.3mm IP44 220-240V

Sensor empotrar crepuscular

Regulable en luz: <5-50lux (regulable).
 Consumo stand-by: 0.45W.
 Sensor: Ø18x25mm / Empotramiento sensor: Ø16mm.

Referencia	Potencia máx.	Tipo	Regulable	Embalaje
001403300	1200W / Incand. 300W / B. Consumo & LED	Crepuscular	Luz	100



180° / 360° 1.5-3.5M 2-10M 39.4x54.5x25mm 220-240V

Detector microondas en techo o luminarias

Tiempo regulable: 10seg. ± 3seg. a 12min ± 1min.
 Distancia detección: 1-8M (Reg.) / Radio techo; 5-15M (Reg.) / Pared.
 Luz ambiental: <3-2000lux (regulable). Consumo stand-by: 0.45W. Temperatura de funcionamiento: -20°C+40°C.
 Sistema HF: 5.8Gz. Radar CW. Banda ISM. Ideal para empotrar en techo o dentro de luminarias (espejos, apliques, etc.).

Referencia	Potencia máx.	Tipo	Regulable	Embalaje
001403692	1200W / Incand. 300W / B. Consumo & LED	Movimiento	Tiempo / Luz / Distancia	100



Avisador de presencia



60°



111x30mm

Tres posiciones: **timbre, alarma y apagado**. Volumen alarma: >70dB.
Máx. metros detección: 8M. Funciona con una pila de 9V. Blíster.

Referencia	Tipo	Embalaje
001400159	Movimiento	40



Avisador presencia inalámbrico



120°

Accionado por detector de movimiento **PIR 120° con alcance de 3M**.
 Indicador batería baja. **Distancia entre emisor/receptor** 80M. **Emisor:** 1x 6LR61 (9V) incluida.
Receptor: 3x LR14. Volumen no regulable. Dim.: 111x30mm. Blíster. **IP40**.

Referencia	Melodías	Decibelios	Embalaje
001401236	8	80-100dB	10/20

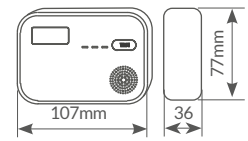

Detector monóxido de carbono

Sensor electrónico y químico. Decibelios: <85dB. Mide la **temperatura, el nivel de CO (PPM) y el estado de la batería**. Botón de prueba y de pausa. Detección de monóxido de carbono **a partir de 10ppm**. Duración: **10 años de vida**. Utiliza 3 pilas LR6 / AA (incluidas). Blíster.

Referencia	PPM	Embalaje
104300001	10-550ppm	20

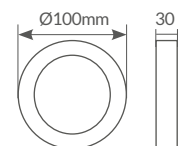

Alarma de humo fotoeléctrica

Alerta batería baja: de 7 a 15 días. Volumen alarma: 85dB. Funciona con una pila de 9V (incluida). Temperatura de funcionamiento: -10°C+40°C. Blíster.

Referencia	Distancia detección	Embalaje
001403695	3M	20



Extractores

Material eléctrico



Nagod EXTRACTOR

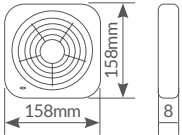

Extractor doméstico

Para conductos de $\varnothing 80\text{mm}$. Caudal de $\pm 70\text{m}^3/\text{h}$. aproximadamente.
Luz piloto de funcionamiento. Tipo: **ultraplano**. Clase II. Motor: 230V.

Referencia	Potencia	Conductos	Embalaje
002703010	10W	$\varnothing 80\text{mm}$	18

Amina EXTRACTOR

Extractores

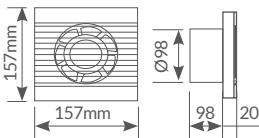

Extractor doméstico

Para conductos de $\varnothing 100\text{mm}$. Caudal de $\pm 150\text{m}^3/\text{h}$. aproximadamente.
Luz piloto de funcionamiento. Tipo: **plano**. Clase II. Motor: 230V.

Referencia	Potencia	Conductos	Embalaje
002700002	20W	$\varnothing 100\text{mm}$	32



Lapai

EXTRACTOR

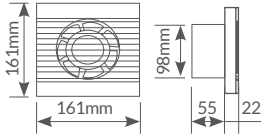

Extractor doméstico con sensor de movimiento

Para conductos de $\varnothing 100\text{mm}$. Caudal de $\pm 80\text{m}^3/\text{h}$. Con **sensor de movimiento**. Distancia de detección 5M. Tiempo de encendido: 1-20'. Ángulo de detección: 45°. Con **protección térmica**. Material: **ABS**. Altura instalación mínima 2.3M. Clase II. Motor: 220-240V~ 50/60Hz. **IPX4**.

Referencia	Potencia	Conductos	Decibelios	Embalaje
400030000	15W	$\varnothing 100\text{mm}$	33dB	20

! Consulta el conexionado en el apartado info técnica.

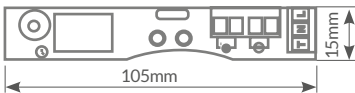
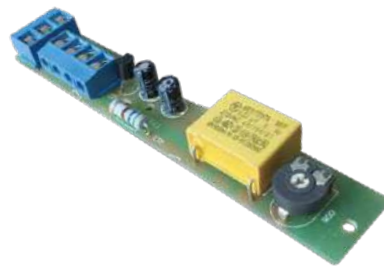

Altura: 10mm

Temporizador para extractores

Utilizar un temporizador por extractor.

Referencia	Regulable	Embalaje
002703011	De 40 seg. hasta 5 min. 40 seg.	300



Programadores

Material eléctrico

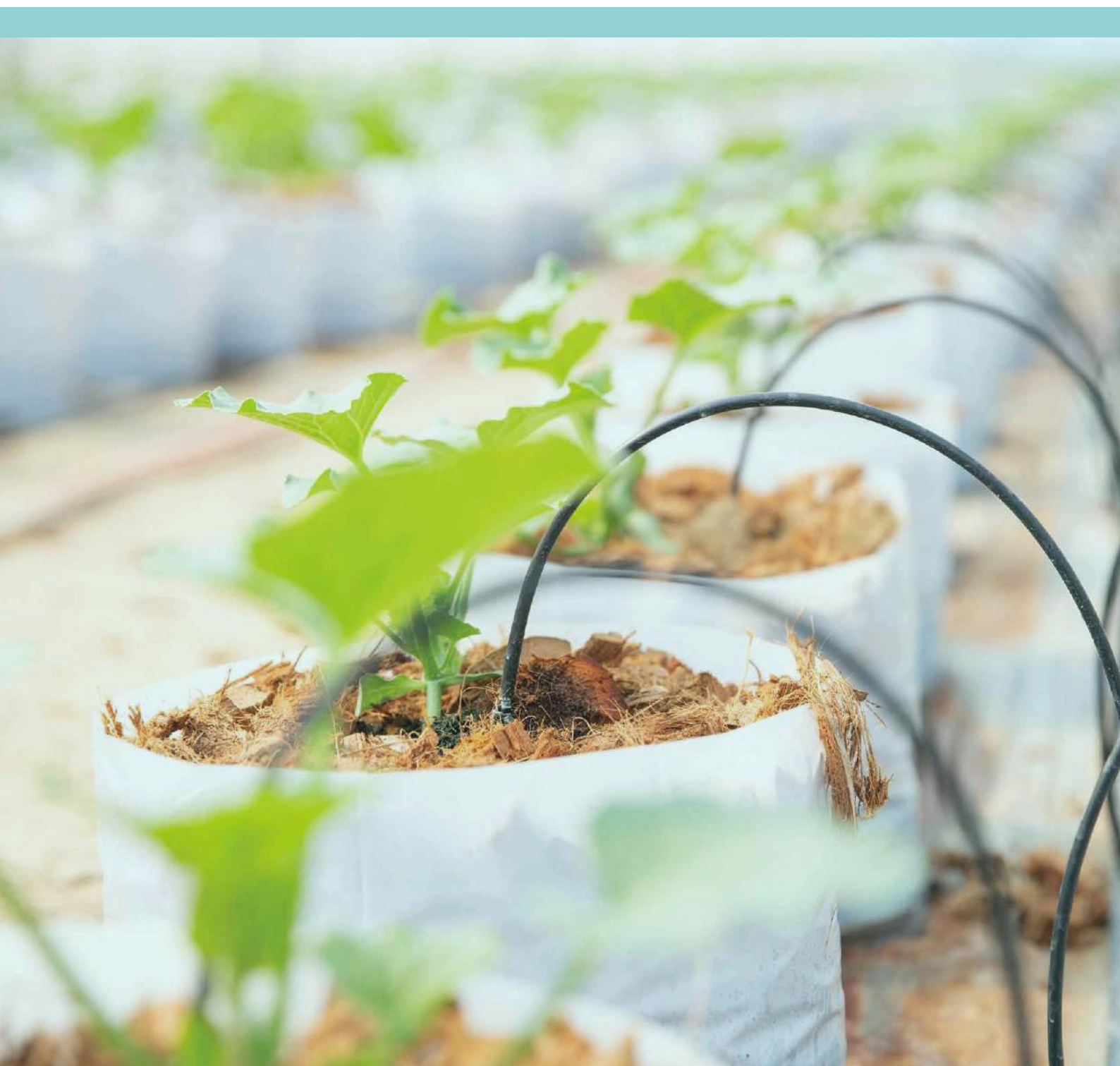



A

16A



230V

Temporizador diario 24h.

Pestañas extraíbles e interruptor. **Programa en intervalos de 15 min.**
Diseñado para enchufe 2P+TT lateral. Blíster.

Referencia	Artículo	Potencia máx.	Indicador LED	Dimensión	Embalaje
000400114	A	3500W	Sí	70x120mm	12/48
000401240	B	3500W	No	60x100mm	12/48



A

16A



230V

Temporizador diario 24h.

Pestañas extraíbles e interruptor. **Programa en intervalos de 15 min.**
Diseñado para enchufe 2P+TT lateral. Blíster.

Referencia	Potencia máx.	Indicador LED	Dimensión	Embalaje
000400270	3500W	No	75x80mm	12/48





A



B

A
16A

B
230V

Temporizador digital diario/semanal

Pantalla digital LCD estable y de fácil lectura.
Con reserva de 100h. Programa en intervalos de 1min.
Diseñado para enchufe 2P+TT lateral.

Referencia	Artículo	Potencia máx.	Indicador LED	Dimensión	Embalaje
000401241	A	3500W	Sí	53x104mm	12/48
000400115	B	3500W	Sí	55x125mm	12/48

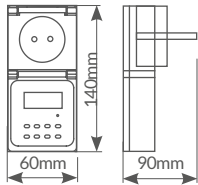

A
16A

IP44

220-240V

Temporizador digital para exterior

Pantalla digital LCD estable y de fácil lectura.
Con reserva de 100h. Programa en intervalos de 1min/mes, semana/día o fin de semana.
Con 6 modos: manual ON, manual OFF, auto, 12/24h., verano y aleatorio.
Material: PC. Diseñado para enchufe 2P+TT lateral.

Referencia	Potencia máx.	Indicador LED	Embalaje
104505001	3680W	Sí	48

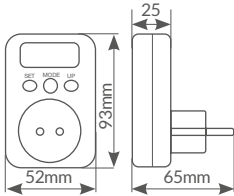

Medidor de consumo eléctrico

A
16A

220-240V

Pantalla digital LCD estable y de fácil lectura.

Controla el consumo. **Calcula el coste de la electricidad** de los electrodomésticos del hogar.

Lectura mínima mostrada en pantalla: 0.5W. **Potencia mínima** mostrada en pantalla 0.01KWH.

Referencia	Potencia máx.	Embalaje
502065006	3680W	50



A
16A

20x85x65mm

230V

Temporizador diario 24h.

Diseñado para ser **montado sobre guías DIN**.

Programa en intervalos de 15 min. Con **reserva de 100 horas**.

Referencia	Potencia máx.	Embalaje
000400269	3500W	10/100

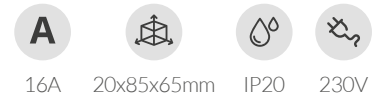

Minutero **escalera**

Regulable en intervalos de 30". Mínimo 1min., máximo 7min.
Diseñado para ser **montado sobre guías DIN.**

Referencia	Potencia máx.	Embalaje
000401239	2300W / Incand. 300W / LED	12/48

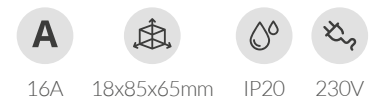

Minutero **escalera**

Regulable dentro del intervalo 30" a 10'.
Diseñado para ser **montado sobre guías DIN.** Conexión a 3 y 4 hilos.

Referencia	Potencia máx.	Embalaje
106515000	2300W / Incand. 1000W / B. Consumo 400W / LED	10/200



Electricidad y protecciones

Material eléctrico



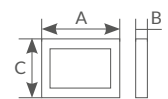

Cuadros eléctricos 8/18 módulos

Curva C. Fabricación según norma: IEC 61008-1.

Cuadro eléctrico **con puerta**. Incluye carril DIN para la instalación de los mecanismos. Fácil y rápida instalación. Indicado para instalaciones en el ámbito doméstico, terciario o industria. Incluye **tapas para un módulo**.

Referencia	Artículo	Para	Instalación	Tapa	Dimensión (AxBxC)	Embalaje
106515001	A	8 módulos	Empotrada	Blanca	221x90x207mm	16
106515002	B	18 módulos	Empotrada	Blanca	397x100x251mm	8
106515003	C	8 módulos	Superficie	Transparente	255x94.5x199mm	16
106515004	D	18 módulos	Superficie	Transparente	362x99x220mm	8
106515005	Tapa para módulos de cuadros eléctricos ref. 106515001 - 02 - 03 - 04					



A Módulo 1P



B Módulo 1P+N

Módulo magnetotérmico estrecho

Automático curva C. Fabricación según norma: IEC 60898-1.

Rango de tensión U_n (VAC): 230/400. **Tensión de aislamiento:** (VAC): 500. **Poder de corte** I_{cn} (KA): 6. **Curva de disparo:** C.

Grado de protección: IP20, con conductores conectados. **Nº de maniobras eléctricas:** 4.000.

Capacidad conexión cable: 0.75-25mm (cable flexible) / 0.75-35mm (cable rígido).

Ideal para **instalaciones residenciales y terciarias.**

Protege la instalación contra cortocircuitos y sobrecargas, su uso también es apto para **control y maniobra.**

Referencia	Artículo	Polos	Amperios	Embalaje
000403649	A	1P	10A	12/24
000403650	A	1P	16A	12/24
000403680	A	1P	20A	12/24
000403651	A	1P	25A	12/24
000403678	A	1P	32A	12/24
000403679	A	1P	40A	12/24

Módulo magnetotérmico doble

Referencia	Artículo	Polos	Amperios	Embalaje
000403652	B	1P+N	10A	6/120
000403653	B	1P+N	16A	6/120
000403681	B	1P+N	20A	6/120
000403654	B	1P+N	25A	6/120
000403655	B	1P+N	32A	6/120
000403656	B	1P+N	40A	6/120



A Módulo 2P



B Módulo 4P

Módulo magnetotérmico **dob**le

Automático curva C. Fabricación según norma: IEC 60898-1.

Rango de tensión U_n (VAC): 230/400. **Tensión de aislamiento:** (VAC): 500. **Poder de corte** I_{cn} (KA): 6. **Curva de disparo:** C.

Grado de protección: IP20, con conductores conectados. **Nº de maniobras eléctricas:** 4.000.

Capacidad conexión cable: 0.75-25mm (cable flexible) / 0.75-35mm (cable rígido).

Ideal para **instalaciones residenciales y terciarias.**

Protege la instalación contra cortocircuitos y sobrecargas, su uso también es apto para **control y maniobra.**

Referencia	Artículo	Polos	Amperios	Embalaje
000403657	A	2P	10A	6/120
000403658	A	2P	16A	6/120
000403682	A	2P	20A	6/120
000403659	A	2P	25A	6/120
000403660	A	2P	32A	6/120
000403661	A	2P	40A	6/120
000403662	A	2P	63A	6/120

Módulo magnetotérmico **cuádruple**

Referencia	Artículo	Polos	Amperios	Embalaje
000403663	B	4P	16A	3/60
000403664	B	4P	20A	3/60
000403665	B	4P	25A	3/60
000403666	B	4P	32A	3/60
000403667	B	4P	40A	3/60
000403668	B	4P	63A	3/60



A Módulo DPN



B Interr. diferencial

Módulo estrecho DPN

DPN interruptor automático curva C. Fabricación según norma: IEC 60898-1.

Rango de tensión U_n (VAC): 230/400. **Poder de corte I_{cn} (KA):** 6. **Curva de disparo:** C. **Grado de protección:** IP20, con conductores conectados. **Nº de maniobras eléctricas:** 4.000. **Capacidad conexión cable:** 0.75-16mm (cable flexible) / 0.75-16mm (cable rígido). Ideal para **instalaciones residenciales y terciarias**. Protege la instalación contra cortocircuitos y sobrecargas. Ancho de 18mm, **indicado para instalaciones con falta de espacio en el cuadro de maniobra**.

Referencia	Artículo	Polos	Amperios	Embalaje
000403669	A	1P+N	10A	12/180
000403670	A	1P+N	16A	12/180
000403683	A	1P+N	20A	12/180
000403671	A	1P+N	25A	12/180
000403672	A	1P+N	32A	12/180
000403673	A	1P+N	40A	12/180

Interruptor diferencial

Clase AC. 30mA. Fabricación según norma: IEC 61008-1.

Rango de tensión U_n (VAC): 230/400. **Grado de protección:** IP20, con conductores conectados. **Señalización de defecto a tierra.** Capacidad conexión cable: 0.75-25mm (cable flexible) / 0.75-25mm (cable rígido). **Clase AC:** corrientes senoidales puras. Ideal para **instalaciones residenciales y terciarias**. **Detecta las corrientes de fuga** producidas en la instalación y desconecta el circuito para la protección de personas.

Referencia	Artículo	Polos	Amperios	Embalaje
000403677	B	2P	25A	10/120
000403674	B	2P	40A	10/120
000403675	B	2P	63A	10/120



Interruptor diferencial

Clase A. Superinmunizado. 30mA. Fabricación según norma: IEC 61008-1.

Rango de tensión U_n (VAC): 230/400. **Grado de protección:** IP20, con conductores conectados. Capacidad conexión cable: 0.75-25mm (cable flexible) / 0.75-25mm (cable rígido). **Clase A:** corrientes senoidales con componente de continua. Ideal para **instalaciones residenciales y terciarias. Detecta las corrientes de fuga** producidas en la instalación y desconecta el circuito para la protección de personas. **Especialmente indicado para instalaciones con problemas de disparos producidos por corrientes pulsantes en la red** (instalaciones con ordenadores, aparatos electrónicos, ...).

Referencia	Polos	Amperios	Embalaje
000403676	2P	40A	10/120



Protector sobretensión permanente + IGA

Curva C. Fabricación según norma: IEC 61008-1.

Protector combinado sobretensiones permanentes está compuesto de una **bobina conectada a un interruptor general automático (IGA)**. **Rango de actuación:** tensión 170V-280V, tensión de trabajo de 230V. Fácil instalación con su fijación en carril DIN. El protector **actúa como un interruptor automático**, es decir **protege** los equipos eléctricos y electrónicos **contra sobrecargas y cortocircuitos**, así como **subidas y bajadas de tensión permanentes, cortes del neutro o defectos de conexión**. Indicado para instalaciones en el ámbito doméstico, terciario o industria. Es obligatorio por ley la instalación de protecciones contra sobretensiones.

Referencia	Polos	Amperios	Embalaje
106505001	2P	25A	120
106505000	2P	32A	4/80



A

10uF 11uF 12uF
15uF 17uF



B

20uF 25uF 30uF 35uF



C

40uF 45uF 50uF



450V

Hz

50/60Hz

Condensador eléctrico

Terminales en forma de U. Con tuerca en la parte inferior.

Referencia	Artículo	Microfaradios	Dimensión	Embalaje
106520000	A	10uF	34x68mm	100
106520001	A	11uF	34x68mm	100
106520002	A	12uF	34x68mm	100
106520003	A	15uF	38x70mm	100
106520004	A	17uF	40x70mm	100
106520005	B	20uF	40x70mm	100
106520006	B	25uF	42x80mm	50
106520007	B	30uF	45x90mm	50
106520008	B	35uF	45x90mm	50
106520009	C	40uF	45x90mm	50
106520010	C	45uF	50x100mm	50
106520011	C	50uF	50x100mm	50

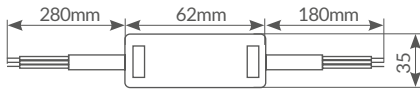

IP67

Protector **sobretensiones**

Protege a los dispositivos conectados en serie de las **subidas de tensión**. Cable: 3x1.0mm².
Ideal para **proyectors, alumbrado industrial y público, luces de pared, luces de tráfico, luces de túneles...**

Referencia	Voltaje	Protección	Amperios	Input	Output	Embalaje
200670001	100-277V	10KV	Máx. 5A	AC / 280mm	AC / 180mm	180



Accesorio **bombillas LED**

Absorbe la luz residual por las interferencias de la red. Evita el paso de energía eléctrica residual.

Referencia	Descripción	Embalaje
002004052	Condensador LED 0.044µf	10



Telecomunicaciones

Material eléctrico

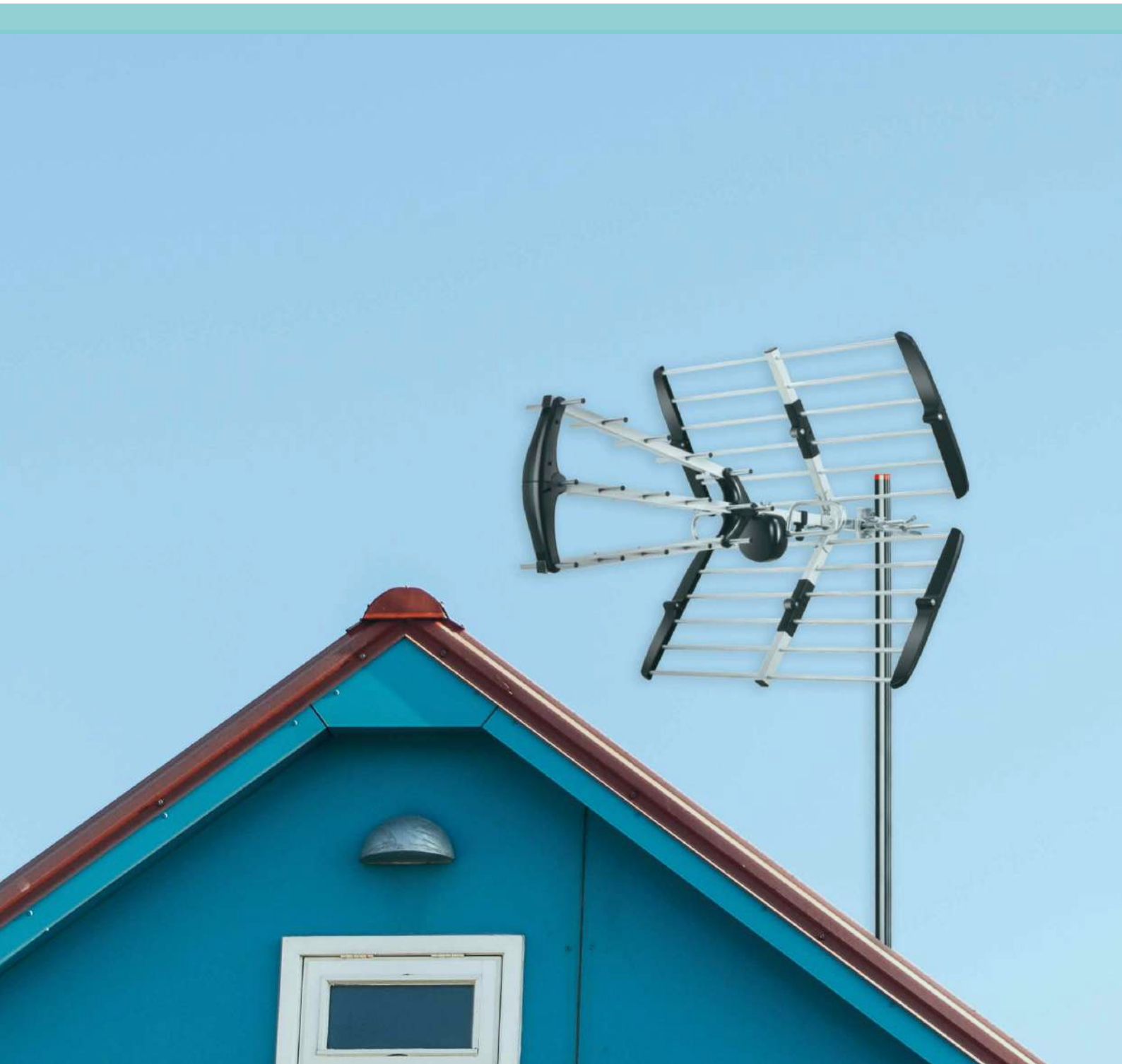



A Acodado



B Recto

Conector TV

Blindado. De Ø9.5mm. IEC. A rosca.

Referencia	Artículo	Modelo	Embalaje
002600900	A	Macho	50/2500
002600901	A	Hembra	50/2500
002600902	B	Macho	50/2000
002600903	B	Hembra	50/2500



C Recto



D Acodado

Conector TV metálico

Blindado. De Ø9.5mm. A rosca.

Referencia	Artículo	Modelo	Embalaje
002603318	C	Macho	25/2000
002603319	C	Hembra	25/2000
002603316	D	Macho	25/1000
002603317	D	Hembra	25/1000





Adaptador conector TV

De Ø9.5mm. IEC.

Referencia	Modelo	Embalaje
002600845	Macho-Macho	10/5000
002600846	Hembra-Hembra	10/5000



Empalmador cable coaxial

Cierre a rosca de las 2 partes del cuerpo protector. IEC.

Referencia	Embalaje
002600904	10/1000



A

De macho
a 2 hembras



B

De hembra
a 2 machos

Distribuidor TV en cruz

De Ø9.5mm.

Referencia	Artículo	Entrada	Salida	Modelo	Color	Embalaje
002600905	A	Macho	2 Hembras	Inductivo	○ Blanco	10/500
002600907	A	Macho	2 Hembras	Inductivo	● Negro	10/1000
002600906	B	Hembra	2 Machos	Inductivo	○ Blanco	10/800
002600908	B	Hembra	2 Machos	Inductivo	● Negro	10/1000





A

De macho
a 2 hembras



B

De hembra
a 2 machos

Distribuidor TV en cruz blindado

De Ø9.5mm.

Referencia	Artículo	Entrada	Salida	Modelo	Embalaje
002600909	A	Macho	2 Hembras	Inductivo	10/500
002600910	B	Hembra	2 Machos	Inductivo	10/500



Distribuidor TV triangular

De Ø9.5mm.

Referencia	Entrada	Salida	Modelo	Embalaje
002600939	Macho	2 hembras blindados	Inductivo	5/500



Cable coaxial TV

De macho a hembra. De Ø9.5mm. Tipo: 3C2V.

Referencia	Artículo	Longitud	Color	Embalaje
002600911	A	1.5M	○ Blanco	250
002600912	A	2.5M	○ Blanco	150
002600913	A	5M	○ Blanco	50
002600914	B	1.5M	● Negro	250
002600915	B	2.5M	● Negro	150
002600916	B	5M	● Negro	50



Cable coaxial TV acodado

De macho a hembra. De Ø9.5mm. Tipo: 3C2V.

Referencia	Artículo	Longitud	Color	Embalaje
002602970	C	1.5M	○ Blanco	150
002602971	C	2.5M	○ Blanco	100
002602972	D	1.5M	● Negro	150
002602973	D	2.5M	● Negro	100





A



B

Cable coaxial TV con filtro

De macho a hembra. De Ø9.5mm. Con filtro. Tipo: **3C2V**.

Referencia	Artículo	Longitud	Color	Embalaje
002601350	A	1.5M	○ Blanco	150
002601351	A	2.5M	○ Blanco	100
002601352	B	1.5M	● Negro	200



Conexión HDMI + HDMI

Interfaz multimedia de alta definición.

Referencia	Versión	Longitud	Color	Embalaje
002600999	1.4	1.8M	● Negro	100
002601292	1.4	3M	● Negro	80
002601293	1.4	5M	● Negro	50



Conexión 4K HDMI + HDMI

Interfaz multimedia de alta definición. Alta velocidad: **10.2Gbps**.

Referencia	Versión	Longitud	Embalaje
002602974	2.0	1.8M	40



Conexión euroconector

De macho a macho de Ø8mm. 21 pins conectados.

Referencia	Longitud	Embalaje
002600922	1.5M	100



Conector metal F macho

De F macho a torsión para cable coaxial de 7mm.

Referencia	Embalaje
002600925	100/5000



Adaptador metal F hembra

De F hembra a F hembra.

Referencia	Embalaje
002600926	50/2500



Adaptador metal F macho

De F macho a F macho.

Referencia	Embalaje
002600927	10/2500



Adaptador hembra a coaxial macho

De hembra a coaxial macho.

Referencia	Embalaje
002601353	25/5000



Distribuidor F triple hembra

De F hembra a 2xF hembra en cruz.

Referencia	Embalaje
002600928	10/3500

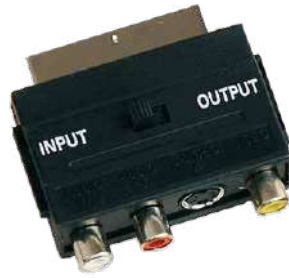

Adaptador euroconector a RCA / s. vídeo

De euroconector (SCART) macho 21 pins a conexión 3xRCA + s. vídeo.
Provisto de conmutador para seleccionar señales de entrada y salida vídeo-audio. IN-OUT.

Referencia	Embalaje
002600921	5/300



Conexión audio-vídeo

De euroconector macho 21 pins a conexión 3xRCA macho. IN-OUT.

Referencia	Embalaje
002600929	200



Conexión audio 2 RCA

De 2 RCA macho a 2 RCA hembra.

Referencia	Longitud	Embalaje
002600933	2.5M	150



Conexión audio 2 RCA

De 2 RCA macho a 2 RCA macho.

Referencia	Longitud	Embalaje
002600934	1.5M	200



Conexión audio-vídeo

De 3 RCA macho a 3 RCA macho.

Referencia	Longitud	Embalaje
002601354	1.5M	100



Conexión audio-estéreo

De jack 3.5 a 2 RCA macho.

Referencia	Longitud	Embalaje
002600931	1.5M	300



Conexión audio-estéreo

De jack 3.5 macho a macho.

Referencia	Longitud	Embalaje
002601355	1.5M	250





Conexión audio-estéreo

De jack 3.5 macho a hembra.

Referencia	Longitud	Embalaje
002601357	3M	200



A



B



C

Distribuidor splitter

Terrestre y satélite. Salida de 5 a 2050Mhz

Referencia	Artículo	Entrada	Salidas	Embalaje
002600936	A	1	2	5/500
002600937	B	1	3	5/250
002600938	C	1	4	5/250

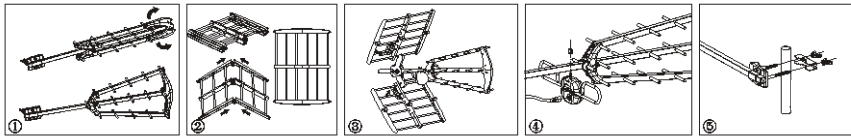
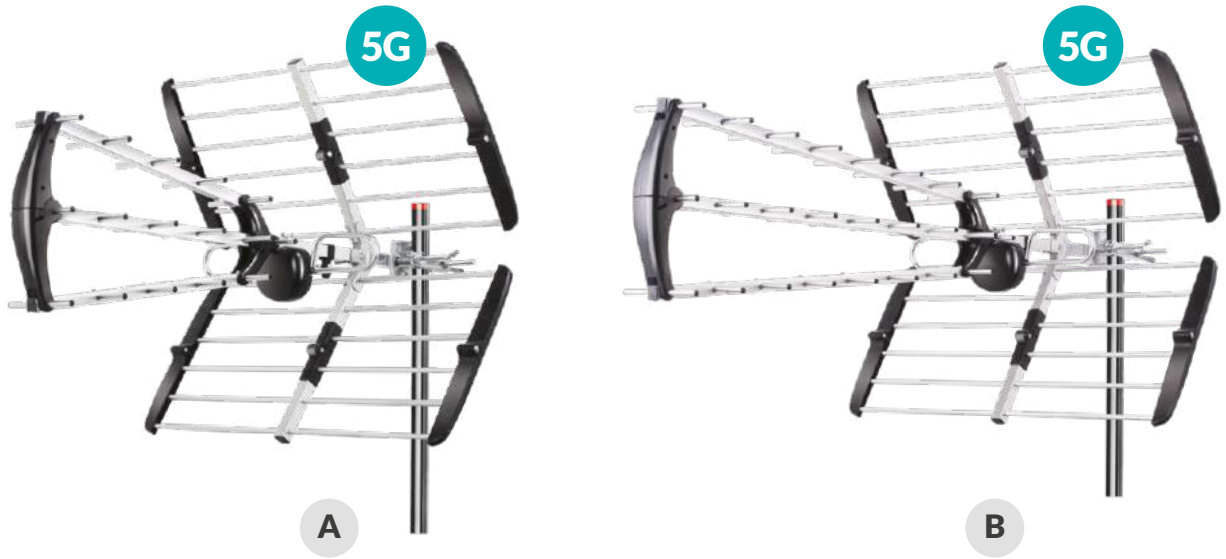

Antena exterior TV

Ideal para **TV digital terrestre (TDT)**. **Ganancia UHF:** 9-13dB.

Distancia de **alcance de hasta 60Km**. **Banda UHF-Canales 21-48. 5G.**

Frecuencia UHF: 470-694MHz. Contiene abrazaderas de sujeción a mástil y caja de conexiones. Antena con un sistema plegable de todas sus partes que permite un reducido tamaño en su transporte. Permite una rápida y fácil instalación.

Material: **Aluminio, plástico y PCB.**

Referencia	Artículo	Elementos	Dimensión	Embalaje
002603320	A	29	800x162x137mm	8

Ideal para **TV digital terrestre (TDT)**. **Ganancia UHF:** 10-15dB. Relación d/A \pm 5dB. Distancia de **alcance de hasta 90Km**.

Banda UHF-Canales 21-48. 5G. Frecuencia UHF: 470-694MHz. Contiene abrazaderas de sujeción a mástil y caja de conexiones.

Antena con un sistema plegable de todas sus partes que permite un reducido tamaño en su transporte. Permite una rápida y fácil instalación.

Material: **Aluminio, plástico y PCB.**

Referencia	Artículo	Elementos	Dimensión	Embalaje
002603321	B	38	1070x160x160mm	8





Mando universal para TV

Pilas no incluidas.

Referencia	Artículo	Para TV	Pila	Embalaje
002402008	A	Samsung	2 x AAA	100
002402009	B	LG	2 x AAA	100
002402010	C	Sony	2 x AA	100
002402011	D	Philips	2 x AAA	100



Mando universal aire acondicionado

Pilas no incluidas.

Referencia	Pila	Embalaje
002402012	2 x AAA	100



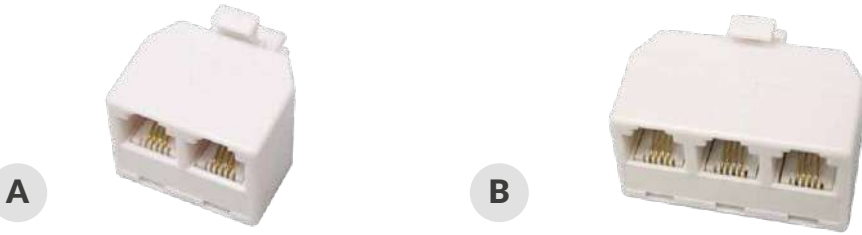

Distribuidor telefónico

6P/4C. RJ11.

Referencia	Artículo	Tipo	Entradas	Embalaje
002600943	A	Modular doble	2	10/1000
002600944	B	Modular triple	3	5/500



Base telefónica de superficie

6P/4C. RJ11.

Referencia	Artículo	Tipo	Montaje a tornillo	Embalaje
002600945	C	Modular de superficie	Sí	10/500
002600948	D	Modular de superficie	No	10/500



Prolongador telefónico

De macho a macho. **6P/6C**. Color: blanco.

Referencia	Longitud	Embalaje
002600950	2.5M	250
002600951	4.5M	200

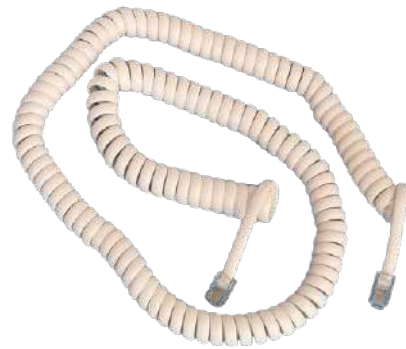

Cable tinsel espiral

De macho a macho. **4P/4C**. Color: blanco.

Referencia	Longitud	Embalaje
002600956	2.1M	250



Adaptador telefónico salida simple

Tipo: modular. De hembra a hembra. **6P/4C. RJ11**.

Referencia	Embalaje
002600958	10/500



Adaptador telefónico 5 salidas

Tipo: modular. De macho a 5 hembras. **6P/4C. RJ11**. Cable: 200mm.

Referencia	Embalaje
002600960	250





Conector telefónico

Tipo: modular. Para cable plano. **6P/4C. RJ11.**

Referencia	Embalaje
002600961	100/20.000

Conector de red ethernet

Tipo: modular. **8P/8C. RJ45. CAT 5E.**

Referencia	Embalaje
002600863	100/400



Cable conexión ethernet

De macho a macho. 8P/8C. Color: blanco. CAT 5E.

Referencia	Longitud	Embalaje
002601360	2.5M	160
002601361	4.5M	100
002601362	7.5M	100



Cargadores y cables USB

Material eléctrico





A

USB macho
a micro USB macho



B

USB a USB tipo C
480Mbps



C

USB a USB tipo C
5Gbps



D

USB tipo C
a USB tipo C



E

USB macho
a USB macho



F

USB macho
a USB hembra

Cables USB

Alta velocidad.

Referencia	Artículo	Versión	Velocidad de carga	Velocidad transferencia	Longitud	Embalaje
001401688	A	2.0	5V / 1A	480Mbps	1M	350
001403685	A	2.0	5V / 1A	480Mbps	1.5M	350
001403686	A	2.0	5V / 1A	480Mbps	2M	350
001402967	B	2.0	5V / 3A	480Mbps	1.5M	300
001402969	C	3.0	5V / 3A	5Gbps	1.5M	300
105515007	D	2.0	5V / 3A	480Mbps	1M	300
105515008	D	2.0	5V / 3A	480Mbps	3M	85
001401689	E	2.0	5V / 1A	480Mbps	1.8M	200
001401691	F	2.0	5V / 1A	480Mbps	1.8M	200

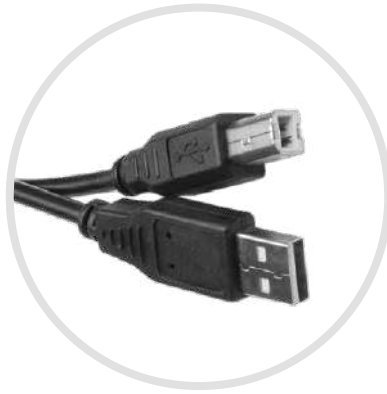

Cable impresora USB

Tipo: **AM/BM**.

Referencia	Versión	Velocidad transferencia	Longitud	Embalaje
001401693	2.0	480Mbps	2M	200



Cable USB para iPhone

Tipo: **conector lighting a USB**. Alta velocidad.

Referencia	Versión	Velocidad transferencia	Longitud	Embalaje
001401649	2.0	480Mbps	1M	350
001403687	2.0	480Mbps	1.5M	350



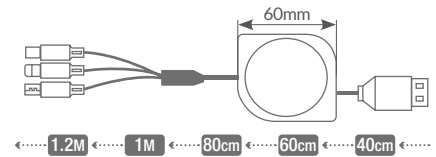

Cable cargador retráctil 3 en 1

3 salidas USB: micro USB, USB C e iPhone Lightning.
Potencia salida: máx. 36W. **Potencia entrada:** máx. 100W.
Voltaje entrada (Input): 100-240V~50-60Hz.
Velocidad de carga (Output): 5V/3A, 9V/2A.
Velocidad de transferencia: 480Mbps.
 Longitud total del cable: **1.2M**. Blíster.

Referencia	Velocidad	Embalaje
105515012	5V / 3A	350



Cargador alargador 2 USB

Voltaje entrada: 110-250V. **Voltaje de salida USB:** 5V/2.4A.
Cable: H03VVH2-F (2x0.5mm). Longitud del cable: **1.5M**.

Referencia	Velocidad	Embalaje
105515004	5V / 2.4A	100

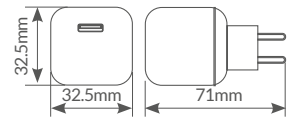

Cargador USB C

Potencia salida: máx. 20W.
Voltaje entrada (Input): 100-240V~50-60Hz.
Velocidad de carga (Output): 5V/3A, 9V/2.22A, 12V/1.67A. Blíster.

Referencia	Velocidad carga	Embalaje
105515010	5V / 3A	200

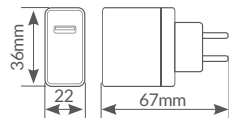

Cargador USB

Voltaje entrada: 100-240V.
 Voltaje de salida de 5V/1A.
 Alta velocidad. Blíster.

Referencia	Velocidad carga	Embalaje
105515000	5V / 1A	300



Cargador 2 USB

Voltaje entrada: 100-240V. Alta velocidad.
 Voltaje de salida de 5V/2A para ambos puertos.
 Si se conectan dos dispositivos a la vez,
 cada dispositivo cargará a 5V/1A. Blíster.

Referencia	Velocidad carga	Embalaje
105515001	5V / 2A	300

* Consulta la potencia de los puertos en el apartado info técnica.





GaN 
Technology

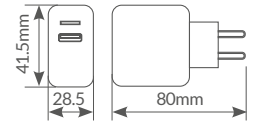

Cargador GaN USB C + A

Carga ultra rápida. Potencia salida: máx. 30W.
Voltaje entrada (Input): 100-240V~50-60Hz.
Velocidad de carga (Output USB A): 5V/3A, 9V/2A, 12V/1.5A.
Velocidad de carga (Output USB C): 5V/3A, 9V/3A, 12V/2.5A, 20V/1.5A.
Velocidad de carga (Output USB C + A): 5V/3A. Blíster.

Referencia	Velocidad carga	Embalaje
105515011	5V / 3A	200



* Consulta la potencia de los puertos en el apartado info técnica.

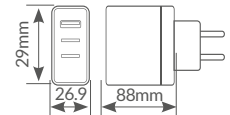
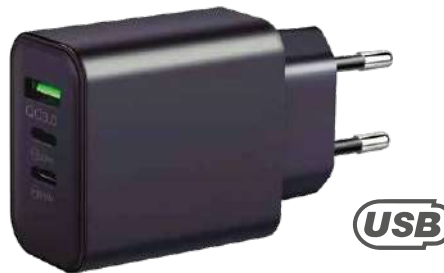

Cargador 230V a 3 USB

USB ultrarrápido **QC3.0 Qualcomm (Quick charge)**.
Voltaje entrada: 100-240V. **Voltaje de salida USB a (QR):** 5V/3A / 9V/2A / 12V/1.5A.
Voltaje de salida Tipo C: 5V/2.3A / 9V/2.22A / 12V/1.67A. **Sistema protección del circuito.** Carga rápida.

Referencia	Velocidad carga	Embalaje
105515006	5V / 6A	140

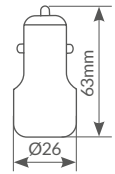

Cargador coche USB C + A QC 3.0

Sistema de **protección de circuito**. **Carga ultra rápida**: al 50% en 30".
Potencia salida: máx. 36W. **Voltaje entrada (Input)**: 12-24V~50-60Hz.
Velocidad de carga (Output USB A): 5V/3A, 9V/2.22A, 12V/1.5A.
Velocidad de carga (Output USB C): 5V/3A, 9V/2.22A, 12V/1.5A. Blíster.

Referencia	Velocidad carga	Embalaje
105515009	5V/3A	250



Alimentador corriente AC/DC

Alimentador universal.
 Salida: 3V, 4.5V, 6V, 7.5V, 9V y 12V. Blíster.

Referencia	Amperios	Embalaje
001400524	500mA	10/40
001400525	1000mA	10/30



Inversor de corriente para coche



200x100x55mm

De 12V a 220V. Con ventilador incorporado.
Con onda senoidal modificada. Con fusible y cable de conexión mechero coche. Con protección contra sobrecarga y sobrecalentamiento. Blíster.

Referencia	Potencia	Embalaje
001400741	300W	5/20
001400201	600W	5/20



Domótica

Material eléctrico



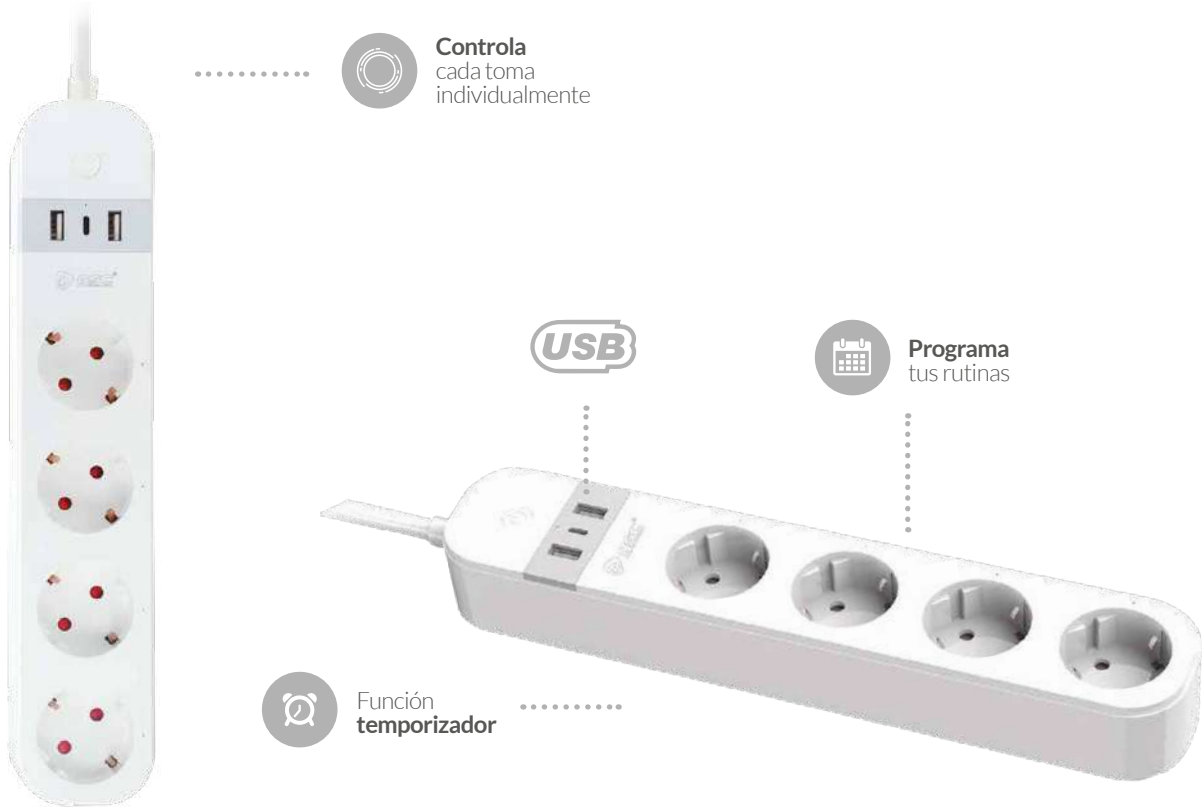

CHILD
 16A
 100-250V

Base múltiple inteligente 4 tomas + 2 USB + Tipo C

Funciona con smartphones, con **Alexa & Google Home**.

Conexión Wifi, función temporizador, control de cada toma de forma individual, programa tus rutinas.

El chip de los USB, detecta y distribuye automáticamente la corriente de carga óptima para cualquier dispositivo conectado.

2 puertos USB + 1 puerto Tipo C: 5V~ Máx. 3A. **Protección contra subidas de tensión y sobrecalentamiento.** Con interruptor.

Administración remota. Controla tus dispositivos inteligentes desde cualquier lugar con tu smartphone.

No necesita Hub. Conexión directa vía Wifi y bluetooth a tus dispositivos.

Referencia	Potencia	Conexiones	Sección	Longitud	Embalaje
100045001	Máx. 3680W	4 tomas + 2 USB + Tipo C	(3x1.5mm)	1.5M	24



CONTROLA TODOS TUS DISPOSITIVOS DESDE TU SMARTPHONE
Compatible con smartphones a partir de la versión Android 4.0 & IOS 8.0



DISFRUTA DE UN HOGAR INTELIGENTE

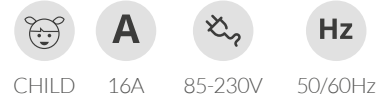
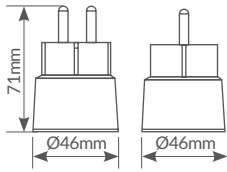

Ladrón base inteligente

Funciona con smartphones, con **Alexa & Google Home. Conexión Wifi.**

Función ON/OFF, temporizador, cuenta atrás y medición de consumo eléctrico.

Administración remota. Controla tus dispositivos inteligentes desde cualquier lugar con tu smartphone.

Consumo stand-by: 0.07W. **No necesita Hub.** Conexión directa vía Wifi a tus dispositivos. Wifi: 2.4GHz.

Referencia	Potencia	Interruptor	Embalaje
103015000	Máx. 3680W	Sí	100



CONTROLA TODOS TUS DISPOSITIVOS DESDE TU SMARTPHONE
Compatible con smartphones a partir de la versión Android 4.0 & IOS 8.0



DISFRUTA DE UN HOGAR INTELIGENTE

Shilok
Interrupitor

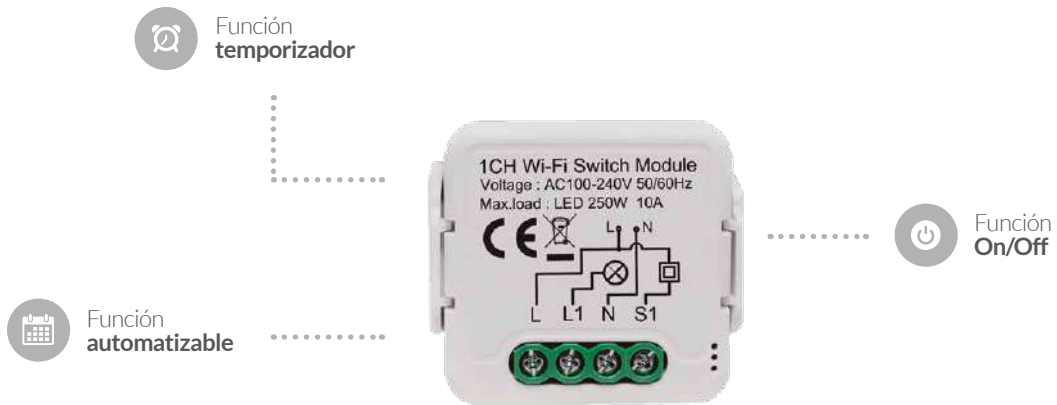

- 
IP20
- 
10A
- 
100-240V
- 
50/60Hz

Interrupitor inteligente Shilok

Funciona con smartphones, **Alexa & Google Home**.
 Funciones: **On/Off / Automatizable / Temporizador**. Wifi: 2.4GHz.
Administración remota. Controla tus dispositivos inteligentes desde cualquier lugar con tu smartphone.
No necesita Hub. Conexión directa vía Wifi a tus dispositivos.

Referencia	Potencia	Material	Dimensión	Embalaje
102525004	Máx. 250W	Polycarbonato	39.2x18x39.2mm	250



CONTROLA TODOS TUS DISPOSITIVOS DESDE TU SMARTPHONE
 Compatible con smartphones a partir de la versión Android 4.0 & IOS 8.0



DISFRUTA DE UN HOGAR INTELIGENTE





Boost

Interruptor



Domótica Material eléctrico

Interruptor Wifi programable Boost

- IP20
- 10A
- 220-240V
- 50Hz

Funciona con smartphones, **Alexa & Google Home**.
 Funciona vía Wifi aunque apagues el interruptor físico. Ideal para empotrar detrás de interruptores y bases de enchufes.
 Funciones: **On/Off / Función automatizable / Temporizador. Tamaño reducido.** Ideal para cualquier caja universal.
Administración remota. Controla tus dispositivos inteligentes desde cualquier lugar con tu smartphone.
No necesita Hub. Conexión directa vía Wifi a tus dispositivos. Wifi: 2.4GHz.

Referencia	Potencia	Material	Dimensión	Embalaje
102525001	Máx. 2300W	Polycarbonato	52x47x17mm	200



CONTROLA TODOS TUS DISPOSITIVOS DESDE TU SMARTPHONE
 Compatible con smartphones a partir de la versión Android 4.0 & IOS 8.0



DISFRUTA DE UN HOGAR INTELIGENTE

Lins
Interruptor

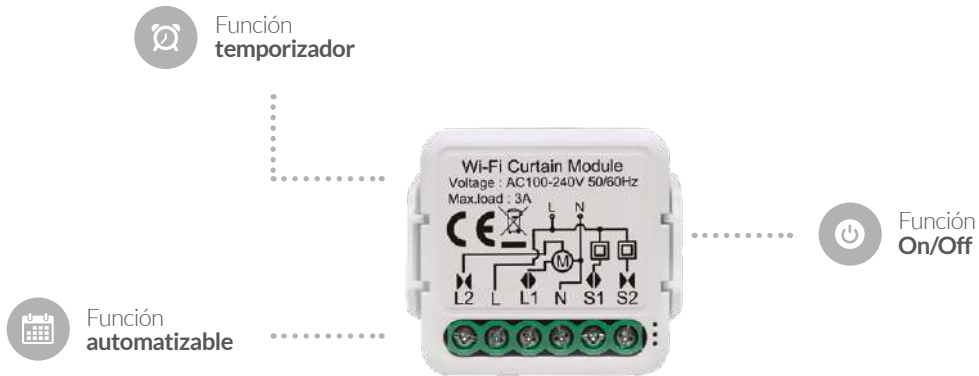

- IP20
- 3A
- 100-240V
- 50/60Hz

Interruptor inteligente para persianas

Funciona con smartphones, **Alexa & Google Home**.
 Funciona vía Wifi aunque apagues el interruptor físico. Ideal para empotrar detrás de interruptores y/o en la caja de registro.
 Funciones: **On/Off / Función automatizable / Temporizador**. **Tamaño reducido**. Ideal para cualquier caja universal.
Administración remota. Controla tus dispositivos inteligentes desde cualquier lugar con tu smartphone.
No necesita Hub. Conexión directa vía Wifi a tus dispositivos. Wifi: 2.4GHz.

Referencia	Potencia	Material	Dimensión	Embalaje
102525005	Máx. 390W	Polycarbonato	43x39.2x22.3mm	100



CONTROLA TODOS TUS DISPOSITIVOS DESDE TU SMARTPHONE
 Compatible con smartphones a partir de la versión Android 4.0 & IOS 8.0



DISFRUTA DE UN HOGAR INTELIGENTE

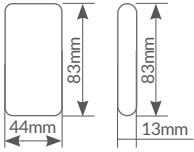

Profundidad: 22mm

Sensor Wifi para puertas y ventanas

Funciona con smartphones, con **Alexa**.

Bajo consumo de batería. Funciona con 2 pilas AA (reemplazable). IP20.

Consumo stand-by: 0.085mW. **Creación de diferentes escenas.** Fijación con cinta adhesiva 3M. Wifi: 2.4GHz.

No necesita Hub. Duración pilas: 6000 veces aprox. (dependiendo del tipo de pila que se ponga).

Referencia	Material	Amperios	Embalaje
104315004	Polycarbonato	37-43mA	100



CONTROLA TODOS TUS DISPOSITIVOS DESDE TU SMARTPHONE
Compatible con smartphones a partir de la versión Android 4.0 & IOS 8.0



DISFRUTA DE UN HOGAR INTELIGENTE



Aviso con notificación



Creación de escenas

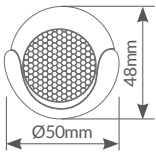

110°



2.5M



IP50

Detector superficie con sensor de movimiento Wifi

Funciona con smartphones, con **Alexa & Google Home**.

Material: policarbonato. **Orientable**. **Temperatura de funcionamiento:** -20°C+60°C.

Intensidad alarma: 120-130mA. **Consumo stand-by:** 0.102mW. Funciona con una pila CR123 3V incluida (reemplazable).

Creación de diferentes escenas. Instalación con adhesivos o con tornillos. Wifi: 2.4GHz.

No necesita Hub. Duración pilas: 2500 veces aprox. (dependiendo del tipo de pila que se ponga).

Referencia	Radio detección	Alimentación	Embalaje
104315002	Máx. 7M	USB 5V / 1A	50



CONTROLA TODOS TUS DISPOSITIVOS DESDE TU SMARTPHONE
Compatible con smartphones a partir de la versión Android 4.0 & IOS 8.0



DISFRUTA DE UN HOGAR INTELIGENTE



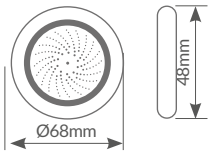

Alarma Wifi

Funciona con smartphones, con **Alexa & Google Home**.

Con sirena, control de temperatura y humedad. Material: policarbonato. 18 sirenas diferentes y 3 volúmenes.

Funciona mediante USB (cable incluido) o con 2 pilas CR123 3V no incluidas (reemplazable). **Consumo stand-by:** 0.35W. IP20.

Creación de diferentes escenas. Instalación con adhesivos o con tornillos. Wifi: 2.4GHz.

Referencia	Alimentación	Decibelios	Embalaje
104315003	USB 5V / 1A	105dB	50



CONTROLA TODOS TUS DISPOSITIVOS DESDE TU SMARTPHONE

Compatible con smartphones a partir de la versión Android 4.0 & IOS 8.0



DISFRUTA DE UN HOGAR INTELIGENTE

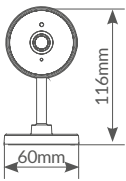

Cámara inteligente

Funciona con smartphones, con **Alexa & Google Home**.

Ángulo de visualización: **horizontal 100° / vertical 60°**. Grabación y reproducción en HD.

Envío de notificación o de alarma al móvil cuando hay detección de movimiento.

Almacenamiento del video: **Micro SD (Máx. 128Gb) / Cloud** (no incl.). Compresión video: H-264. Admite varios dispositivos.

Imagen sensor: 1/3" Color CMOS. **Visión nocturna de infrarrojos**.

Posibilidad de hablar desde el teléfono a la cámara y de la cámara al teléfono.

Instalación en techos y/o pared. DC 5V / 1A. Red Wi-Fi 2.4GHz.

Administración remota. Controla tus dispositivos inteligentes desde cualquier lugar con tu smartphone.

No necesita Hub. Conexión directa vía Wifi a tus dispositivos. Incluye cable USB, cinta adhesiva 3M y clip para resetear cámara. Peso 75gr.

Referencia	Infrarrojos	Definición	Embalaje
405025001	Máx. 10M	720P-1MP	50



CONTROLA TODOS TUS DISPOSITIVOS DESDE TU SMARTPHONE

Compatible con smartphones a partir de la versión Android 4.0 & IOS 8.0



DISFRUTA DE UN HOGAR INTELIGENTE



Calunda

Cámara



Conexión WIFI

Con alarma sonora

Posibilidad de hablar desde el teléfono

Función programar grabación

Vídeo y audio en directo

Sobremesa Techo

355°

90°

ONVIF®
Protocolo

Ø91mm
128mm
97mm

Cámara inteligente

Funciona con smartphones, con **Alexa & Google Home**.

Ángulo de rotación: **horizontal 355° / vertical 90°**. Grabación y reproducción en HD.

Envío de notificación o de alarma al móvil cuando hay detección de movimiento.

Almacenamiento del video: **Micro SD (De 8Gb a 128Gb) / Cloud**. Admite varios dispositivos. **Visión nocturna de infrarrojos hasta 10M**.

Posibilidad de hablar desde el teléfono a la cámara y de la cámara al teléfono.

Cargador USB y cable incluido. Instalación en techos y/o pared. DC 5V / 1A. Red Wi-Fi 2.4GHz.

Administración remota. Controla tus dispositivos inteligentes desde cualquier lugar con tu smartphone.

No necesita Hub. Conexión directa vía Wifi a tus dispositivos.

Referencia	Infrarrojos	Definición	Embalaje
405025002	Máx. 10M	1080P-2MP	50



CONTROLA TODOS TUS DISPOSITIVOS DESDE TU SMARTPHONE
Compatible con smartphones a partir de la versión Android 4.0 & IOS 8.0



DISFRUTA DE UN HOGAR INTELIGENTE



3 MODOS DE GRABACIÓN



**MODO A
VISIÓN INTELIGENTE**

Grabación a color, con movimiento.
Grabación en b/n, sin movimiento.



**MODO B
INFRARROJOS**

Grabación a color.
Con y sin movimiento.



**MODO C
IMAGEN A B/N**

Grabación en b/n.
Con y sin movimiento.

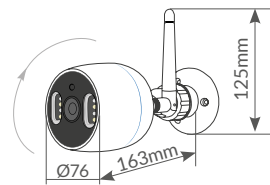

Cámara exterior inteligente

Funciona con smartphones, con **Alexa & Google Home**.

Ángulo de lente: **85°**. **Grabación y reproducción en HD**. Admite Varios dispositivos. **Vídeo y audio en directo**. Entrada y salida de audio.

Detección de movimiento. **Visión nocturna de infrarrojos**. Con **alarma** sonora. Luz blanca imagen color.

Almacenamiento del vídeo: **Micro SD (Máx. 128Gb) / Cloud**. Instalación en techos o pared. DC 12V / 1A. Red Wi-Fi 2.4GHz.

Administración remota. Controla tus dispositivos inteligentes desde cualquier lugar con tu smartphone.

Adaptador USB incluido. **No necesita Hub**. Conexión directa vía Wifi a tus dispositivos. **IP65**.

Referencia	Definición	Modos de grabación	Embalaje
405025000	1080P-2MP	3	20



CONTROLA TODOS TUS DISPOSITIVOS DESDE TU SMARTPHONE

Compatible con smartphones a partir de la versión Android 4.0 & IOS 8.0



DISFRUTA DE UN HOGAR INTELIGENTE





Neale

Cámara

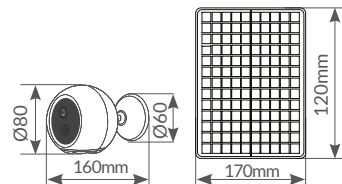

Cámara vigilancia solar inteligente

Funciona con smartphones, con **Alexa & Google Home**.

Ángulo de lente: **100°**. **Grabación y reproducción en HD**. Admite varios dispositivos. **Vídeo y audio en directo**. Audio bidireccional.

Detección de movimiento 120°. **Visión nocturna de infrarrojos hasta 6M**. **Carga solar autónoma**.

Almacenamiento del vídeo: **Micro SD (Máx. 128Gb) / Cloud**. Instalación en pared 2.6M. DC 5V / 1.5A.

Administración remota. Batería 2x18650 / 5000mAh. Autonomía días nublados: 3-4 días.

Controla tus dispositivos inteligentes desde cualquier lugar con tu smartphone. Panel solar policristal 3W/5V.

Notificación al móvil. **No necesita Hub**. Conexión directa vía Wifi a tus dispositivos. **IP66**.

Referencia	Definición	Modos de grabación	Embalaje
405025003	1080P-2MP	3	20



CONTROLA TODOS TUS DISPOSITIVOS DESDE TU SMARTPHONE

Compatible con smartphones a partir de la versión Android 4.0 & IOS 8.0



DISFRUTA DE UN HOGAR INTELIGENTE

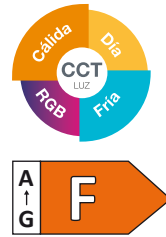

Bombilla LED inteligente

Funciona con smartphones, con **Alexa & Google Home**.

Regulable en intensidad luminosa y temperatura regulable.

Posibilidad de regular de forma gradual con **memoria del último estado de color**.

Se pueden **controlar hasta 10 bombillas a la vez**. Conexión WIFI 2.4-2.5GHz.

Administración remota. Controla tus dispositivos inteligentes desde cualquier lugar con tu smartphone.

No necesita Hub. Conexión directa vía Wifi a tus dispositivos. Uso interior.

Referencia	Potencia	Lúmenes	Casquillo	Luz	Dimensión	Embalaje
200651005	5.5W	400Lm	GU10	● RGB + CCT	Ø50x56mm	10/50



CONTROLA TODOS TUS DISPOSITIVOS DESDE TU SMARTPHONE
Compatible con smartphones a partir de la versión Android 4.0 & IOS 8.0



DISFRUTA DE UN HOGAR INTELIGENTE

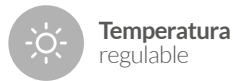
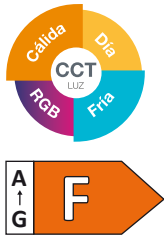

Bombilla LED inteligente Wifi + Bluetooth

Funciona con smartphones, con **Alexa & Google Home**.

Regulable en intensidad luminosa y temperatura regulable.

Posibilidad de regular de forma gradual con **memoria del último estado de color**.

Se pueden **controlar hasta 10 bombillas a la vez**. Conexión **WIFI con asistencia bluetooth** 2.412-2.484GHz.

Administración remota. Controla tus dispositivos inteligentes desde cualquier lugar con tu smartphone.

Material: **aluminio + PC. No necesita Hub.** Conexión directa vía Wifi a tus dispositivos. Uso interior. **IP20.**

Referencia	Artículo	Potencia	Lúmenes	Casquillo	Luz	Dimensión	Embalaje
200651002	A	5.5W	470Lm	E14	● RGB + CCT	Ø47.5x88mm	10/100
200651003	B	5.5W	470Lm	E27	● RGB + CCT	Ø48x80mm	10/100
200651004	C	5.5W	470Lm	E14	● RGB + CCT	Ø38x106mm	10/100



CONTROLA TODOS TUS DISPOSITIVOS DESDE TU SMARTPHONE
Compatible con smartphones a partir de la versión Android 4.4 & IOS 8.0



DISFRUTA DE UN HOGAR INTELIGENTE

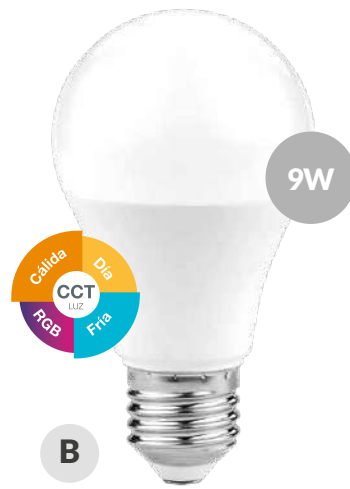
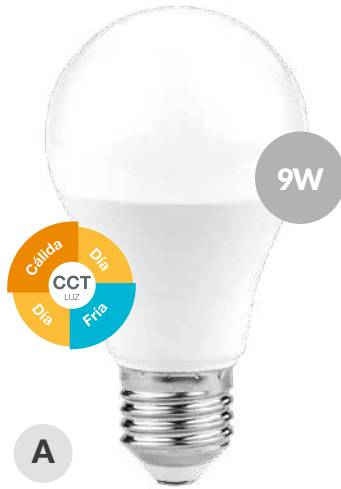

Intensidad regulable



Temperatura regulable



Conexión automática



200°



10.000



≥80Ra



20.000h.



220-240V

Bombilla LED inteligente Wifi + Bluetooth

Funciona con smartphones, con **Alexa & Google Home**.

Regulable en intensidad luminosa y temperatura regulable. Posibilidad de regular de forma gradual con **memoria del último estado de color**.

Se pueden **controlar hasta 10 bombillas a la vez**. Conexión **WIFI con asistencia bluetooth** 2.4-2.5GHz.

Administración remota. Controla tus dispositivos inteligentes desde cualquier lugar con tu smartphone.

No necesita Hub. Conexión directa vía Wifi a tus dispositivos. Uso interior. **IP20**.

Referencia	Artículo	Potencia	Lúmenes	Casquillo	Luz	Dimensión	Embalaje
200651001	A	9W	800Lm	E27	CCT	Ø60x118mm	10/100
200651000	B	9W	800Lm	E27	● RGB + CCT	Ø60x118mm	10/100



CONTROLA TODOS TUS DISPOSITIVOS DESDE TU SMARTPHONE
Compatible con smartphones a partir de la versión Android 4.4 & IOS 8.0



DISFRUTA DE UN HOGAR INTELIGENTE



Intensidad regulable



Temperatura regulable



Conexión automática



120°



10.000



≥80Ra



20.000h.



12V

Tira LED 5M inteligente Wifi + Bluetooth

Funciona con smartphones, con **Alexa & Google Home**.

Regulable en intensidad luminosa (de 10% a 100%) y **temperatura regulable** (RGB + 2700K-6000K).

Posibilidad de regular de forma gradual con **memoria del último estado de color**. Se pueden **controlar hasta 10 tiras a la vez**.

Compatible con smartphones a partir de la **versión Android 4.4 & IOS 8.0**. Conexión **WIFI con asistencia Bluetooth 2.4-2.5GHz**.

Incluye: fuente de alimentación y regulador. **Kit preparado para conectar. Cinta adhesiva 3M**.

Es posible cortar por las zonas delimitadas cada metro.

Administración remota. Controla tus dispositivos inteligentes desde cualquier lugar con tu smartphone.

No necesita Hub. Conexión directa vía Wifi a tus dispositivos. **Anchura: 12mm. Altura: 3mm. Uso exterior. IP65**.

Referencia	Potencia	Lúmenes	Luz	Embalaje
204035001	24W / 4.8W/M	220Lm/M	RGB - CCT	10

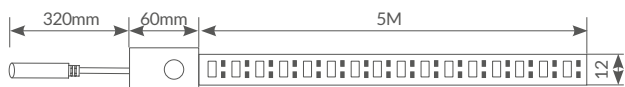

CONTROLA TODOS TUS DISPOSITIVOS DESDE TU SMARTPHONE

Compatible con smartphones a partir de la versión Android 4.4 & IOS 8.0



DISFRUTA DE UN HOGAR INTELIGENTE

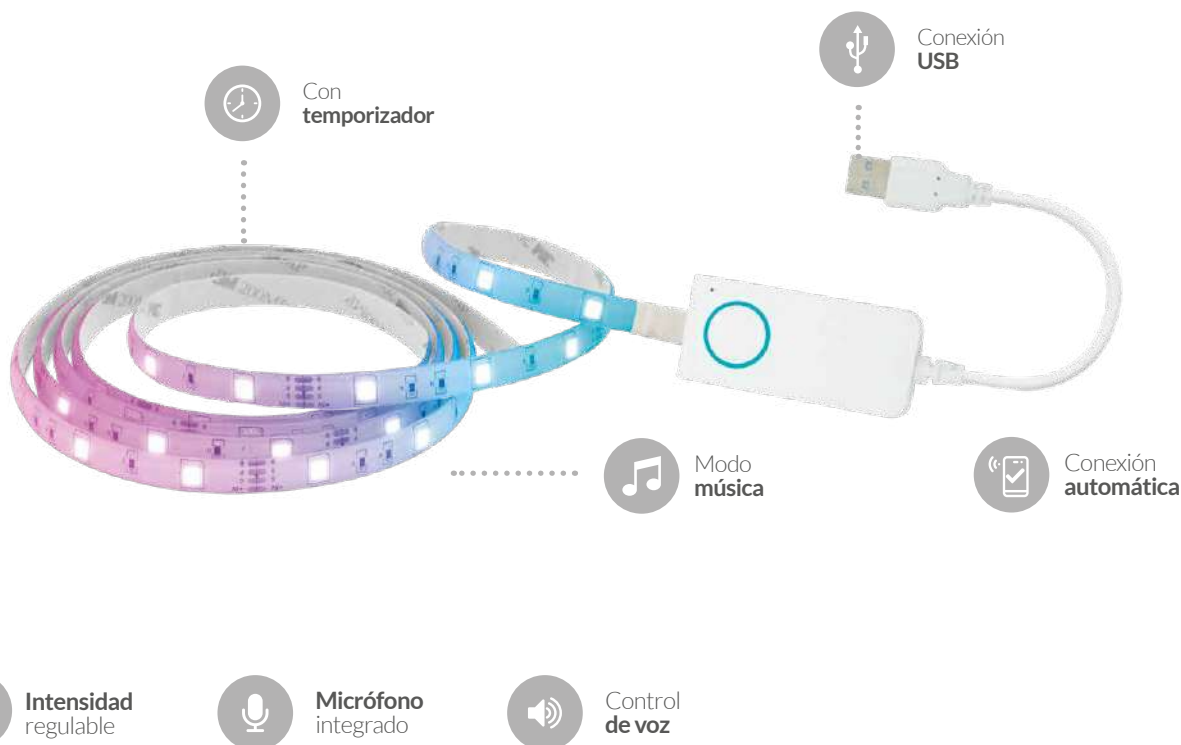

- 120°
- 10.000
- ≥80Ra
- 20.000h.
- 5V

Kit 2M tira LED Bluetooth inteligente

Funciona con smartphones, con **Alexa & Google Home**.

Regulable en intensidad luminosa. Conexión USB.

Posibilidad de regular de forma gradual con **memoria del último estado de color**. Se pueden **controlar hasta 10 tiras a la vez**.

Compatible con smartphones a partir de la **versión Android 4.4 & IOS 8.0**. Conexión **Bluetooth 2.4-2.5GHz**.

Incluye: fuente de alimentación y regulador. **Kit preparado para conectar. Cinta adhesiva 3M**.

Es posible cortar por las zonas delimitadas cada 333mm. **Funciona con USB**, no necesita fuente de alimentación.

Administración remota. Controla tus dispositivos inteligentes desde cualquier lugar con tu smartphone.

No necesita Hub. Conexión directa vía Wifi a tus dispositivos. **Anchura: 192mm. Altura: 10mm. Uso exterior. IP44.**

Referencia	Potencia	Lúmenes	Luz	Embalaje
204035002	Máx. 10W	30Lm/M	RGB	200



CONTROLA TODOS TUS DISPOSITIVOS DESDE TU SMARTPHONE

Compatible con smartphones a partir de la versión Android 4.4 & IOS 8.0



DISFRUTA DE UN HOGAR INTELIGENTE

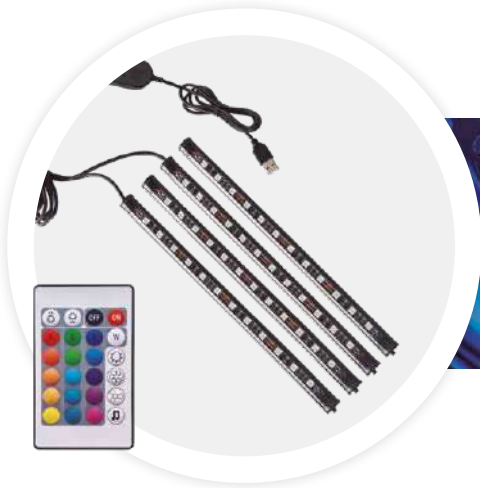

Cambia de color al ritmo de la música



Kit 4 tiras LED USB 230mm inteligente para coche RGB

- RGB
- 120°
- 10.000
- ≥80Ra
- 10.000h.
- IP20

Intensidad regulable. Función temporizador, micrófono integrado, control de voz. **Cinta adhesiva 3M.** Con **sensor rítmico:** cambia al ritmo de la música. Incluye **mando.** Alimentación **USB DC 5V.** Fácil instalación, sin herramientas.

Referencia	Potencia	SMD	Luz	Embalaje
204035004	5W	5050	RGB	5



CONTROLA TODOS TUS DISPOSITIVOS DESDE TU SMARTPHONE
Compatible con smartphones a partir de la versión Android 4.4 & IOS 8.0

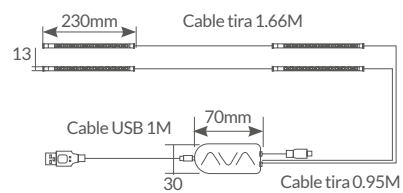

DISFRUTA DE UN HOGAR INTELIGENTE



Linternas

Iluminación





42x72x300mm

Linterna lectura LED

Ángulo ajustable y pinza de sujeción.
Con cable USB 50cm. Pila litio incluida. **Autonomía:** 10h.

Referencia	Color	Pila	Embalaje
201800004	● Negro	1x1100	100



115x20x240mm

Linterna LED 3 aumentos

Ideal para leer, para **pequeñas cosas**, para ver mapas, ... Blíster.

Referencia	Potencia	Lúmenes	Pila	Embalaje
001603221	3W	250Lm	2xAA	12/48



Ø100x205mm

Lupa de mano **5X aumento de LED**

18 LEDs. Autonomía: 1.5h. Material: **ABS. Vidrio óptico doble capa.** Agarre ergonómico. Pilas no incluidas. Peso: 240gr. Diámetro lupa: Ø80mm. Ideal para leer, para **pequeñas cosas**, para ver mapas,...

Referencia	Potencia	Lúmenes	Pila	Embalaje
201825008	3W	180Lm	3xAAA	32

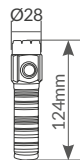

Linterna de mano **LED recargable USB**

5 modos. Presión larga: 100%, 50%, 25% y flash lento. Doble click: flash rápido. **Autonomía:** 2.5. Tiempo de carga: sobre 3-4h. Incluye: **gancho, imán, cable USB de 30cm.** Micro USB. Batería de litio de 18650 de 2200mAh 5V, incluidas.

Referencia	Potencia	Lúmenes	Distancia alumbrado	Embalaje
201825015	10W	700Lm	100M	10/20



Tiempo de carga: 2h.
Autonomía: 30min. hasta 9h.
(según el modo).

Tiempo de carga: 3.5h.
Autonomía: 30min. hasta 7h.
(según el modo).

Tiempo de carga: 3.5h.
Autonomía: 30min. hasta 7h.
(según el modo).

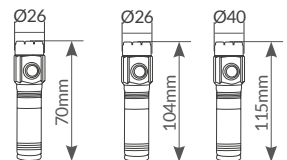

Linterna de mano LED recargable USB

5 modos: bajo, medio, alto, muy alto; doble click para modo turbo; presión larga para flash rápido, flash lento, flash rojo.
Incluye: **clip para cinturón y cable USB tipo C** de 30cm. Material: **aluminio**. IPX4.

Referencia	Potencia	Lúmenes	Nº LEDs	Batería litio (Incl.)	Dist. alumbrado	Embalaje
201825016	Máx. 12W	Máx. 1000Lm	3	16340 / 700mAh 3.7V	20-105M	50
201825017	Máx. 20W	Máx. 2000Lm	5	18650 / 2000mAh 3.7V	47-148M	50
201825018	Máx. 30W	Máx. 3000Lm	8	20650 / 2600mAh 3.7V	66-214M	50



Mini linterna trabajo LED COB ultrafina

Modos: alta, media, baja, flash. Presión larga: cambio de luz blanca (baja, media y alta) / cálida (baja, media y alta).
 Doble clic: modo turbo COB + flash. **Autonomía:** 30min. a 10h. (según el modo).
 Tiempo de carga: sobre 2h. Incluye: **gancho, clip para cinturón, cable USB de 30cm.**
 Batería de litio de 602040 de 450mAh 3.7V, incluidas.

Referencia	Potencia	Lúmenes	Distancia alumbrado	Embalaje
201815012	3W / LED superior 5W / LED frontal	200Lm / LED superior 500Lm / LED frontal	40M	24



70x55x340mm

Linterna LED de taller

Dos modos: ON / OFF. Tipo LED: **SMD.** Distancia alumbrado: 25M. **Autonomía:** 3h.
 Tiempo de carga: sobre 3h. Incluye: **gancho, imán, cable USB de 1M.**
 Pilas con **circuito de protección** de sobrecarga / descarga. Pila de litio de 18500 de 2700mAh. Pilas incluidas.

Referencia	Potencia	Lúmenes	Pila	Embalaje
001603245	10W	200Lm	1x18500	96



Linterna petaca de LED

Dos modos: Luz cálida / Luz roja trasera.
 Amplio enfoque gracias al difusor.
Distancia alumbrado: 5M. Pilas no incluidas. Blíster.

Referencia	Potencia	Lúmenes	Pila	Embalaje
001603234	0.5W	28.3Lm / 30.4Lm	3xAA o 3R12	12/72

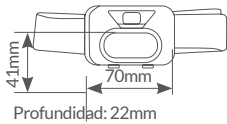

Linterna cabeza LED

Tres modos interruptor: Máxima intensidad / Media intensidad / Flash. Material: **ABS**.
 Cinta regulable. **Autonomía:** 3h. **Distancia alumbrado:** 10M. **IP44**.

Referencia	Potencia	Lúmenes	Pila	Embalaje
201805007	3W	108Lm	3xAAA	24/96



Linterna cabeza de LED

Display 12 unidades.

Dos modos: luz blanca / luz roja. Cinta regulable.

Material: ABS. Distancia alumbrado: 10M. Pilas incluidas.

Referencia	Potencia	Lúmenes	Pila	Embalaje
001603251	1W	80Lm	3xAAA	12/144



Linterna cabeza LED recargable

Display 12 unidades.

Modos: Máxima intensidad / Baja intensidad / Flash.

Autonomía: 2-5h. Tiempo de carga: 2h. Cargador micro USB incluido (200mm).

Batería de litio 1450 / 500mAh / 3.7V incluidas.

Material: ABS. Distancia alumbrado: 10M.

Referencia	Potencia / Lúmenes	Batería	Embalaje
201805008	1W / 80Lm LED 1W / 60Lm SMD	1x 500mAh	12/96

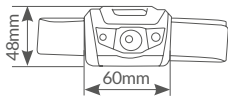

Profundidad: 37mm

CREE LED



Linterna cabeza LED + sensor

Sensor de movimiento.

Tres modos interruptor: Máxima intensidad / Media intensidad / Parpadeo. **Dos modos sensor:** Máxima intensidad / Media intensidad. **Sensor:** mover la mano hacia la luz frontal para apagar / encender la luz a una distancia máxima de 10cm. Material: **ABS**. Cinta regulable. **Autonomía:** 2h. (máxima intensidad) y 3.5h. (media intensidad). **Distancia alumbrado:** 25M. Tiempo carga: 3h. y 4h. Se puede cargar con cualquier adaptador con salida de 1000mAh 5V. Batería con **circuito de protección** de carga / descarga. Cable para cargar incluido. **Encender / Apagar** el sensor: mantener presionado el botón durante 3 segundos hasta que aparezca la luz roja. Batería de litio de 1200mAh de 3.7V incluida.

Referencia	Potencia	Lúmenes	Batería	Embalaje
001603252	3W	160Lm	De litio	50/100

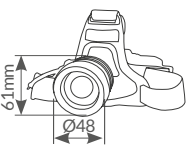

Linterna frontal LED COB recargable

4 modos: luz LED, luz COB, luz mixta y flash mixta. Cabezal abatible.

Autonomía: 3.5h. (luz LED), 3h. (luz COB), 2h. (luz mixta), 5-6h. (flash mixto). Tiempo de carga: 5-6h. Cinta regulable. Cargador **USB incluido**. Batería de litio 18650 2 x 1800mAh de 3.7V incluidas. Material: **aluminio**. **Distancia alumbrado:** 90M. **IPX4**.

Referencia	Potencia	Lúmenes	Batería	Embalaje
201805002	5W + 3W COB	800Lm	2 x 1800mAh	20

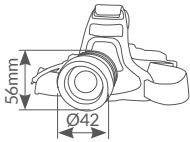

Linterna frontal LED recargable con zoom

3 modos: luz 100%, luz 50% y flash.
 Cabezal abatible. **Objetivo con zoom.**
Autonomía: 3.5h. (luz 100%), 7-8h. (luz 50%), 9-10h. (flash).
 Tiempo de carga: 5-6h. Cinta regulable. Cargador **USB incluido.**
 Batería de litio 18650 3 x 1800mAh de 3.7V incluidas.
 Material: **aluminio.** **Distancia alumbrado:** 110M. **IPX4.**

Referencia	Potencia	Lúmenes	Batería	Embalaje
201805003	10W	1000Lm	3 x 1800mAh	20

El **sensor** se activa con la mano

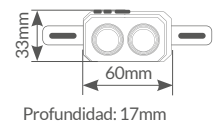

Linterna cabeza LED COB recargable + sensor

Modos: Máxima intensidad / Baja intensidad / Flash.
Autonomía: 2-5h. **Tiempo de carga:** 1h. Cargador **USB tipo C incluido 30cm.**
 Batería de litio 602030 / 350mAh / 3.7V incluidas. Cinta regulable.
 Material: **ABS + PMMA.** **Distancia alumbrado:** 50M. **IPX3.**

Referencia	Potencia / Lúmenes	Batería	Embalaje
201805009	3W / 120Lm COB 3W / 100Lm SMD	350mAh	80

El sensor se activa con la mano



Profundidad: 28mm

Linterna cabeza LED COB recargable + sensor

Modos: Máxima intensidad / Baja intensidad / Flash. LED COB blanco, LED COB cálido y LED SMD.
Autonomía: COB 3.5-8h. / SMD 2.5-8h. **Tiempo de carga:** 4h. Cargador USB tipo C incluido 50cm.
 Batería de litio 18650 / 1200mAh / 3.7V incluidas. Cinta regulable.
 Material: TPR + ABS. **Distancia alumbrado:** 50M. IPX3.

Referencia	Potencia / Lúmenes	Batería	Embalaje
201805010	6W / 1250Lm COB 3W / 50Lm SMD	1200mAh	120

El sensor se activa con la mano



Linterna cabeza LED COB 5W con sensor

4 modos: luz COB 100%, luz COB 50%, luz SMD 100%, luz SMD 50%.
Autonomía: 2.5h-3h. Tiempo de carga: 4-5h. Cinta regulable. Cargador USB a cable tipo C incluido.
 Batería de litio 1200mAh incluida. Botón On/Off. Material: **silicona**. **Distancia alumbrado:** 65M. IPX4.

Referencia	Potencia	Lúmenes	Batería	Embalaje
201805004	5W	300Lm	1200mAh	100



Ø19x70mm

Linterna llavero LED + abridor de botellines

Display 24 unidades.

Modo: ON / OFF. Tipo: telescópico. 3LEDs. Material: aluminio.

Distancia alumbrado: 2M. Pilas incluidas.

Referencia	Potencia	Lúmenes	Pila	Embalaje
001603238	0.2W	10Lm	3xLR44	24/96



70x30mm

Linterna llavero LED

Display 24 unidades.

Modo: ON / OFF. LED COB. Material: goma.

Distancia alumbrado: 10M. Incluye mosquetón. Pilas incluidas.

Referencia	Potencia	Lúmenes	Pila	Embalaje
201825013	1W	60Lm	2xCR2032	24/192





45x20x61mm

Mini linterna LED con abridor

Display 12 unidades.

Cuatro modos: Máxima intensidad / Media intensidad / Baja intensidad / Parpadeo. Tipo LED: **COB**.

Con **imán, gancho y abridor**. Material: **aluminio**. **Distancia alumbrado:** 30M. Cargador USB tipo C incluido 300mm.

Referencia	Potencia	Lúmenes	Batería	Embalaje
201825012	3W	350Lm	300mAh	12/48



Ø87x20mm

Linterna circular LED COB

Display 12 unidades.

Tres modos: Media intensidad / Máxima intensidad / Parpadeo. Tipo LED: **COB**. Con **gancho**. Material: **ABS + PS**.

Distancia alumbrado: 8M. Pilas alcalinas incluidas.

Referencia	Potencia	Lúmenes	Pila	Embalaje
001603240	2W	80Lm	3xAAA	12/48



Ø26x90mm

Linterna con clip de LED

Display 12 unidades.

Tres modos: Media intensidad / Máxima intensidad / Parpadeo. Con clip de metal.

Material: aluminio. Distancia alumbrado: 50M. Pilas incluidas.

Referencia	Potencia	Lúmenes	Pila	Embalaje
001603230	3W	150Lm	1xAA	12/96



Ø30x100mm

Linterna 9 LEDs de goma

Display 12 unidades.

Alta luminosidad. Material: goma.

Con cuerda para colgar. Distancia alumbrado: 40M.

Pilas alcalinas incluidas.

Referencia	Potencia	Lúmenes	Pila	Embalaje
001601403	1W	55Lm	3xAAA	12/48



Ø30x100mm

Linterna 9 LEDs aluminio

Display 12 unidades.

Alta luminosidad. Material: **aluminio**. Distancia alumbrado: 25M. Con cuerda para colgar. Pilas alcalinas incluidas.

Referencia	Potencia	Lúmenes	Pila	Embalaje
001600889	2W	45Lm	3xAAA	12/48



CREE LED



Ø39x166mm

Linterna LED de mano

Display 12 unidades.

Cinco modos: Media intensidad / Máxima intensidad / Baja intensidad / Flash / SOS. Con cuerda y zoom. Material: **aluminio**. Autonomía: 2.5h. Distancia alumbrado: 300M. Pilas incluidas.

Referencia	Potencia	Lúmenes	Pila	Embalaje
201825014	10W	450Lm	3xAAA	12/48



80x63x195mm

Linterna multiusos + luz de noche

Display 12 unidades.

Material: PP. Distancia alumbrado: 10M. Pilas incluidas.

Referencia	Potencia	Lúmenes	Pila	Embalaje
001603244	1W + 6x0.25W	40-50Lm	2xAA	12/48



60x210mm

Linterna LED COB rectangular

Display 12 unidades.

Tipo LED: COB. Alta luminosidad. Material: ABS.

Con gancho giratorio e imán para colgar. Pilas alcalinas incluidas.

Referencia	Potencia	Lúmenes	Pila	Embalaje
201815009	3W	120Lm	3xAA	12/24



130x35x100mm

Linterna LED multiusos

Display 6 unidades.

Tipo LED: **COB + LED**. Material: **PS**. Autonomía: 6h. Con **asa**.

Dos modos: Máxima intensidad / Baja intensidad. **Distancia alumbrado**: 5M. Pilas alcalinas incluidas.

Referencia	Potencia	Lúmenes	Pila	Embalaje
20180006	3W COB / 1W LED	210Lm COB / 130Lm LED	3xAAA	6/48

Linternas Display



87x20x11mm

Mini linterna trabajo LED 3W

Display 12 unidades.

Tipo LED: **COB**. Alta luminosidad. 2 modos de luz. Cable de **carga USB** incluido. Tiempo de carga: 2-4h.

Material: **ABS + aluminio**. **Distancia alumbrado**: 25M. Batería recargable 800mAh.

Con **clip** e **imán** colgar. Batería incluida.

Referencia	Potencia	Lúmenes	Batería	Embalaje
201815003	3W	300Lm COB	800mAh	12/48



71x40x100mm

Linterna trabajo LED COB

Display 8 unidades.

Tres modos: Máxima intensidad / Media intensidad / Baja intensidad. Tipo LED: **COB**. Con **imán y gancho** para colgar.

Asa regulable 360°. Alta luminosidad. Cable de **carga USB** incluido. Material: **ABS**. **Autonomía**: 2.5h.(100%), 4h.(50%), 10h. (20%).

Distancia alumbrado: 50M. 3.7V. **Tiempo de carga**: 3-3.5h.

Referencia	Potencia	Lúmenes	Batería	Embalaje
201815002	6W	1000Lm	1800mAh	8/64



110x65x35mm

Linterna trabajo LED COB

Display 6 unidades.

Tipo LED: **COB**. Con **imán y gancho** para colgar.

Alta luminosidad. Cable de **carga USB** incluido. Material: **ABS**.

Distancia alumbrado: 20M. Batería recargable **powerbank**.

Referencia	Potencia	Lúmenes	Batería	Embalaje
201815001	7W	500Lm	3400mAh	6/24



Linterna trabajo LED COB recargable

Display 6 unidades.

Modos: Luz cálida / Luz fría.

Tipo LED: **COB**. Con **imán y gancho** para colgar. Base ajustable 180°.

Autonomía: 4-7h. **Tiempo de carga:** 3h. Cargador **USB C incluido** (500mm).

Batería de litio 1860 / 1500mAh / 3.7V incluidas.

Material: **aluminio + ABS**. **Distancia alumbrado:** 15M.

Referencia	Potencia / Lúmenes	Batería	Embalaje
201815010	5W / 350Lm COB 3W / 50Lm XPE	1 x 1500mAh	6/48



Linterna solar LED COB recargable



Display 6 unidades.

4 modos: LED On / COB Alto / COB Medio / COB Bajo. Tipo LED: **COB**. Material: **TPR**.

Carga solar. Cargador **USB tipo C incluido**. Longitud cable: 400mm. **Autonomía:** 2.5h.(100%), 5h.(50%).

Distancia alumbrado: 15M. 3.9V. **Tiempo de carga:** 4-6h. Función **powerbank**. Con **soporte y gancho**.

Referencia	Potencia	Lúmenes	Batería	Embalaje
201840001	5W COB + 1W LED	750Lm COB / 55Lm LED	4000mAh	9/96



Linternas Display

Linterna trabajo LED COB



95x31x80mm

Display 8 unidades.

5 modos: LED Alto / Led Medio / COB Alto / COB Medio / Flash rojo. Tipo LED: COB.

Alta luminosidad. Material: ABS. Autonomía: 4h. Máx. Distancia alumbrado: 10M.

Con imán y gancho para colgar. Pilas incluidas.

Referencia	Potencia	Lúmenes	Pilas	Embalaje
201815008	5W COB + 1W LED	220Lm COB / 50Lm LED	3xAAA	1



100x50x100mm

Linterna solar LED camping recargable

2 modos LED SMD central: Máxima intensidad / Baja intensidad.

3 modos LED lateral: Máxima intensidad / Baja intensidad / Flash. Material: **ABS**.

Carga solar. Cargador **USB tipo C** incluido. Longitud cable: 300mm. **Autonomía:** 6-8h.

Distancia alumbrado: 20M(SMD) / 30M (LED). 5V 60mA. **Tiempo de carga:** USB 2-3h / Solar 6-8h.

Función **powerbank**. Con **soporte y gancho**.

Referencia	Potencia	Lúmenes	Batería	Embalaje
201840002	3W LED + 3W SMD	290Lm	1200mAh	40



Linternas Display

Linterna LED multiusos con set de destornilladores

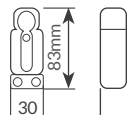

37

Display 6 unidades.
6 tipos de destornilladores: PH0, PH1, PH2, 3mm, 4mm, 5mm.
Luz LED delantera y trasera. Material: ABS. Pilas incluidas.

Referencia	Potencia	Lúmenes	Pilas	Embalaje
201800007	0.5W	10Lm	3xLR44	6/48

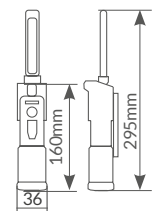

Linterna de trabajo LED **recargable USB**

3 modos LED COB cálida: Máxima intensidad / Baja intensidad / Luz roja.

3 modos LED COB día: Máxima intensidad / Baja intensidad / Flash rojo. Función **powerbank recargable**.

Autonomía: 5h. máx. Tiempo de carga: 2-3h. Cargador **USB incluido 0.5M**. Con **imán en la base**.

USB y micro USB. Batería de litio 1200mAh incluida. Material: **AL + ABS**. Con pinza de sujeción, gancho e imán. IPx4.

Referencia	LED COB	XPE	Distancia alumbrado	Embalaje
201815015	5W/240Lm	3W/150Lm	50M	50

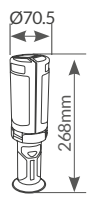

Linterna de trabajo LED recargable USB

5 modos: LED 100%, LED + SMD 10%, LED + SMD 60%, LED + SMD 100% y flash. Función **powerbank recargable**.

Autonomía: 3.5h. máx. Tiempo de carga: 4-6h. Cargador **USB incluido 1M**. Con **imán en la base**.

USB y micro USB. Batería de litio 18650 2200mAh de 3.7V incluida. Material: **ABS**. Con asa para colgar. IP20.

Referencia	SMD	LED	Distancia alumbrado	Embalaje
201815004	5W / 600Lm	1W / 150LM	100M	20

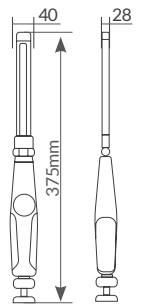
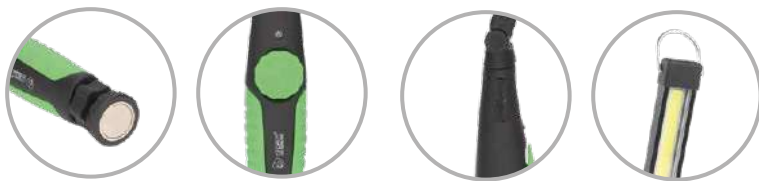
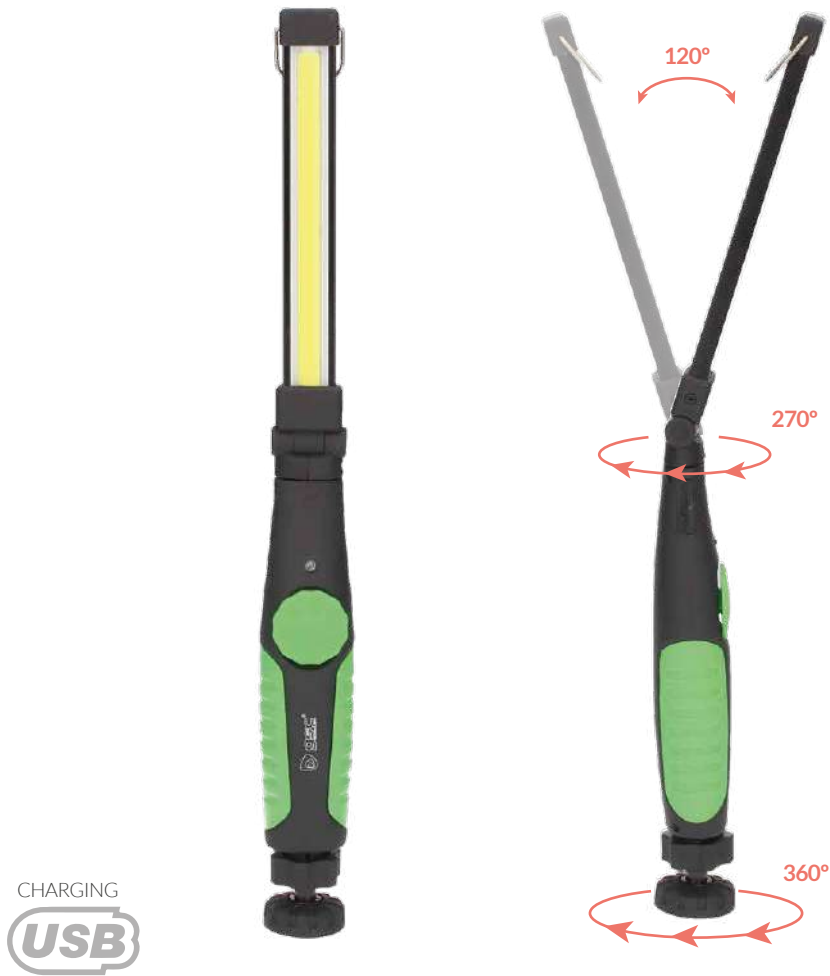

Linterna de trabajo LED **recargable USB**

Con **regulador de intensidad**.

Autonomía: 2.5h. máx. **Tiempo de carga:** 2-3h. **Cargador USB incluido 50cm.** Con **imán giratorio en la base.** Micro USB. **Batería de litio 18650 1500mAh de 3.7V incluida.** **Material: ABS.** Con asa para colgar. IP20.

Referencia	Potencia	Lúmenes	Distancia alumbrado	Embalaje
201815006	3W	300Lm	100M	50

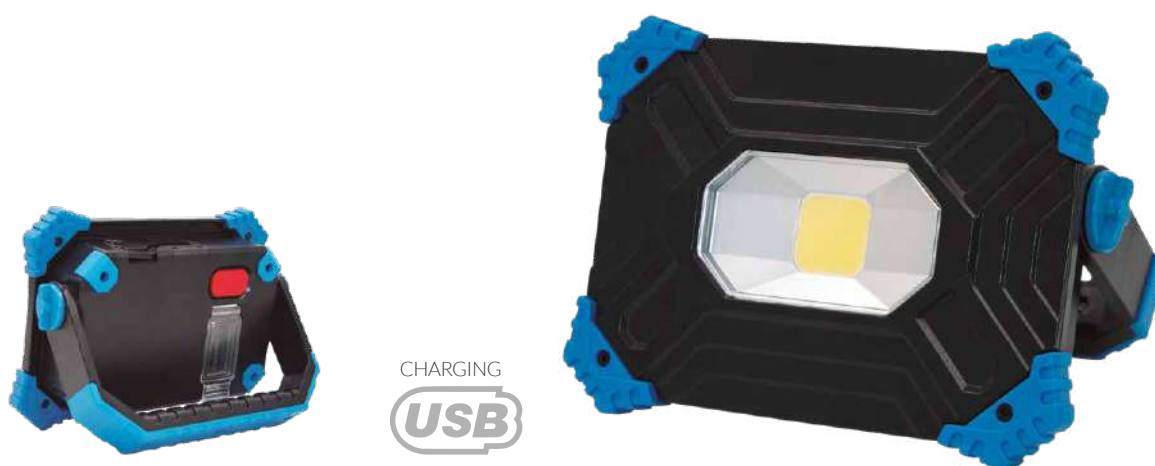

Linterna de trabajo LED COB **recargable Powerbank**

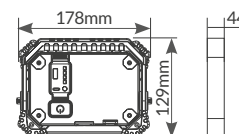

3 modos: Máxima intensidad / Media intensidad / Baja intensidad. Función **powerbank recargable USB A**.
Autonomía: 10h. máx. Tiempo de carga: 5-6h. Cargador **USB tipo C incluido 1M**. Con **imán y gancho** para colgar.
 Soporte trasero **ajustable 180°**. Batería de litio 18650 6600mAh de 3.7V incluida. Material: **plástico + Aluminio**. IP54.

Referencia	Potencia	Lúmenes	Distancia alumbrado	Embalaje
201815013	20W	2000Lm	10M	15



Convertible
en trípode

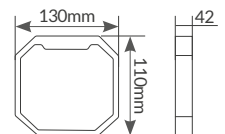

Linterna de trabajo LED **recargable Powerbank**

3 modos: Máxima intensidad / Media intensidad / Baja intensidad. Función **powerbank recargable**.

Autonomía: 8h. máx. Tiempo de carga: 4h. Cargador **USB tipo C incluido 50cm**. Con **4 imanes y gancho** para colgar.

Mango **convertible en trípode**. Batería de litio 18650 2x1200mAh de 3.7V incluida. Material: **PC+ABS**. IPX4.

Referencia	Potencia	Lúmenes	Distancia alumbrado	Embalaje
201815011	15W	1200Lm	10M	40



Hojas
desplegables
120°

CHARGING
USB

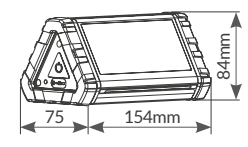

Linterna de trabajo LED COB **recargable**

2 modos: Máxima intensidad / Baja intensidad. **Autonomía:** 3h. máx.
 Tiempo de carga: 4-5h. Cargador **USB tipo C incluido 1M.** Con **imán en la base y gancho** para colgar.
 Hojas **desplegables 120°.** Batería de litio 18650 3600mAh de 3.7V incluida. Material: **plástico. IP54.**

Referencia	Potencia	Lúmenes	Distancia alumbrado	Embalaje
201815014	10W	1000Lm	7M	15

Linternas Trabajo

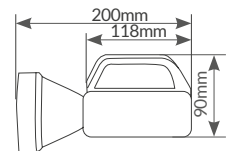

Linterna multiusos LED **recargable Powerbank**

3 modos: Alta intensidad / Baja intensidad / Flash. Función **powerbank recargable**.

Material: **ABS**. Con asa. **Distancia alumbrado:** 10M.

Autonomía: 2-3h. **Tiempo de carga:** 2h. Cargador **USB C incluido** (300mm).

Batería de litio 18650 / 800mAh / 3.7V incluidas. **IP65**.

Referencia	Potencia / Lúmenes	Batería	Embalaje
201800009	3W / 210Lm SMD 3W / 150Lm COB	1 x 800mAh	50



CREE LED



203x113x158mm

IP65

Linterna LED **recargable Powerbank**

Tres modos: Alta intensidad / Baja intensidad / Parpadeo.
 Material: **ABS**. Mango **convertible en trípode**. Interruptor ON/OFF. Con asa.
Distancia alumbrado: 500M/LED, 150M/COB.
 Indicador de batería baja. Con cable de carga USB / Tipo C.
 Batería de litio 2x2400mAh / 3.7V incluidas.

Referencia	Potencia / Lúmenes	Batería	Embalaje
201800001	5W / 400Lm SMD 5W / 150Lm COB	2x2400mAh	8



IP20



230V

Lámpara portátil industrial

Cable eléctrico H05RN-F (2x0.75mm).
Con rejilla metálica, gancho e **interruptor** luminoso.

Referencia	Potencia	Longitud	Embalaje
000600472	Máx. 60W	5M	20
000600197	Máx. 60W	10M	20



IP54



230V

Lámpara portátil industrial

Con rejilla metálica, gancho y cristal protector.
Cable eléctrico H05RN-F. **Mango aislante** de goma.

Referencia	Potencia	Longitud	Embalaje
501010001	Máx. 60W	5M	16



Ø105x121mm

Linterna LED camping farolillo

Display 8 unidades.

2 modos: luz fría y efecto llama. Ideal para iluminar el jardín. **28 LED's cálidos + 24 LED's fríos.** Con asa para colgar y transportar.

Material: **ABS.** **Autonomía:** 5h. Máx. autonomía. **Distancia alumbrado:** 5M. Pilas incluidas.

Ideal para camping.

Referencia	Potencia	Lúmenes	Pilas	Embalaje
201810002	1W	30Lm	3xAAA	1

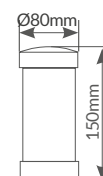

Linterna camping LED

3 modos: Máxima intensidad / Baja intensidad / Off.

Con asa para colgar. Material: **ABS.** **Distancia alumbrado:** 8-10M. Pilas incluidas. **IP44.**

Referencia	Potencia	Lúmenes	Pila	Embalaje
201810001	1W	150Lm	3xAA	6/24

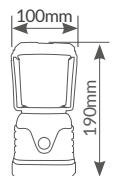

Linterna camping LED recargable USB powerbank

4 modos: luz fría, luz cálida, luz mixta y flash mixta. Función **powerbank recargable**.

Autonomía: 7h. (luz fría), 5h. (luz cálida), 3h. (luz mixta) y 7h. (flash mixto).

Con asa 180° y gancho para colgar. Cargador **USB incluido**.

Material: ABS. **Distancia alumbrado:** 25M. **IP44**.

Referencia	Potencia	Lúmenes	Batería	Embalaje
201810000	10W	1000Lm	4000mAh	20



72x21x22mm



IP44

Luz trasera bicicleta LED recargable USB

Alta luminosidad. Múltiples posiciones en **horizontal** o **vertical**.
Correa ajustable. Batería 500mAh.
 Material: **ABS.** Fácil montaje.

Referencia	Modos	Cable de carga	Batería	Embalaje
201835001	4	USB (incluido)	500mAh	100



Delantera
39x42x74mm



Trasera
70x29x45mm



XP2

Set luces bicicleta LED recargables USB

Luz delantera: alta luminosidad. **Resistente a salpicaduras.**
 Agarre ergonómico. Batería 1000mAh. Material: **aluminio + ABS.**
Luz trasera: posición en **horizontal** o **vertical**.
Correa ajustable. Batería 350mAh. Material: **ABS.** Fácil montaje.

Referencia	Luz delantera	Luz trasera	Cable de carga	Embalaje
201835000	5 modos	4 modos	USB (incluido)	40



110x105x35mm

Linterna multiusos 15 LEDs

Cinco modos: 3 luces blancas / Parpadeo rojo circular / Parpadeo efecto emergencia / Parpadeo rojo lento / Luz roja fija.
 Tipo: **multiusos**. Material: **ABS**. Con **gancho e imán**. Ideal como luz nocturna, para ir de camping, etc. Pilas no incluidas.

Referencia	Potencia	Lúmenes	LEDs	Pilas	Embalaje
201800002	2W + 1W	100Lm + 50Lm	12 rojos / 3 blancos	3xAAA	100



Señalización adicional a los triángulos



Ideal para llevar en el coche



Potente imán para colocar en la chapa del vehículo



360°



Botón 360°
Luz emergencia



Botón
Linterna

CUMPLE NORMATIVA DE SEGURIDAD VIAL

Real decreto 2822/1998 del Reglamento General de Vehículos



Ø65x40.5mm / Base Ø90mm

IP54

Baliza señalización de emergencia V16

Tres modos: Modo luz de emergencia / Modo linterna luz blanca alta intensidad / Modo linterna luz blanca baja intensidad.

Tipo: **multiusos**. Material: **PC**. Con **gancho e imán**. **Visible a 1Km de distancia y 360°**.

Se puede adherir a la chapa del vehículo o colocar sobre una superficie plana. Pilas alcalinas incluidas.

Referencia	Lúmenes	Luz	Pilas	Embalaje
201800003	120Lm COB	1800K SMD / 6000K COB	3xAAA	100

HOMOLOGADA & AUTORIZADA



Conectada con **Telefónica Tech**

CUMPLE NORMATIVA DE SEGURIDAD VIAL
Real decreto 1030/2022 del Reglamento General de Vehículos

Baliza señalización de emergencia V16 con geolocalización

Ø68x51mm / Base Ø94mm IP54

Material: **PC**. Con **sistema de sujeción magnética**. **Visible a 1Km de distancia y 360°**. Autonomía: 4h. Botón: On/Off. **Sistema de geolocalización incorporado**. Informa de la ubicación del producto de forma anónima. **Incluye tarjeta SIM**. Conectada a 2 plataformas: **DGT 3.0 y a Telefónica Tech**. Garantiza **15 años de conectividad**. Se puede adherir a la chapa del vehículo o colocar sobre una superficie plana. **Resistencia al viento**: 180Pa. Pilas alcalinas incluidas.

Referencia	Luz	Frecuencia	Pilas	Embalaje
201800008	1800K SMD	0.8-2Hz	3xAA	100

HOMOLOGADA & AUTORIZADA POR LA DGT



Linternas Señalización



Interior

Iluminación



Chandur

SERIE



A Fijo / Redondo

Blanco Níquel Satín



B Basculante / Redondo

Blanco Níquel Satín

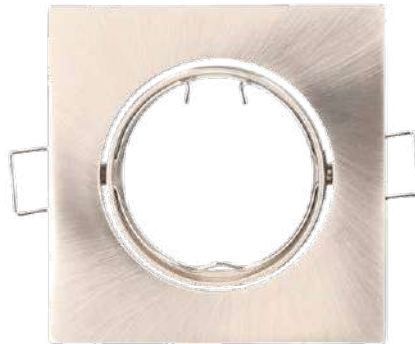

C Basculante / Cuadrado

Blanco Níquel Satín

Aros empotrables

Para lámparas dicroicas. Material: **aluminio fundido**. Portalámparas **GU10 incluido**.

Referencia	Artículo	Tipo	Forma	Potencia	Color	Dimensión	Empotr.	Embalaje
200405013	A	Fijo	Redonda	Máx. 50W	○ Blanco	Ø80x22mm	Ø66mm	10/100
200405014	A	Fijo	Redonda	Máx. 50W	● Níquel Satín	Ø80x22mm	Ø66mm	10/100
200405015	B	Basculante	Redonda	Máx. 50W	○ Blanco	Ø84x22mm	Ø74mm	10/100
200405016	B	Basculante	Redonda	Máx. 50W	● Níquel Satín	Ø84x22mm	Ø74mm	10/100
200405017	C	Basculante	Cuadrada	Máx. 50W	○ Blanco	84x84x22mm	Ø74mm	10/100
200405018	C	Basculante	Cuadrada	Máx. 50W	● Níquel Satín	84x84x22mm	Ø74mm	10/100

Undi

SERIE



A



B



C



D

Aros empotrables **anti deslumbramiento**

Forma: **redonda**. Para lámparas dicroicas.

Material: **PC**. Portalámparas **GU10 incluido**. IP20.

Referencia	Artículo	Tipo	Potencia	Color	Dimensión	Empotramiento	Embalaje
200405009	A	Fijo	Máx. 10W	○ Blanco mate	Ø89x28mm	Ø70mm	20/100
200405010	B	Fijo	Máx. 10W	● Negro mate	Ø89x28mm	Ø70mm	20/100
200405011	C	Basculante	Máx. 10W	○ Blanco mate	Ø85x28mm	Ø70mm	20/100
200405012	D	Basculante	Máx. 10W	● Negro mate	Ø85x28mm	Ø70mm	20/100

Fana

SERIE



Aros fijos empotrables

Tipo: **fijo**. Forma: **redonda**.
Para lámparas dicroicas. Material: **aluminio**. Portalámparas **GU10 incluido**. IP20.

Referencia	Potencia	Color	Dimensión	Empotramiento	Embalaje
200405003	Máx. 10W	○ Blanco mate	Ø77x25mm	Ø63mm	20/100
200405004	Máx. 10W	● Negro mate	Ø77x25mm	Ø63mm	20/100

Mebrat

SERIE



Aros basculantes empotrables

Tipo: **basculante**. Forma: **redonda**.
Para lámparas dicroicas. Material: **aluminio**. Portalámparas **GU10 incluido**. IP20.

Referencia	Potencia	Color	Dimensión	Empotramiento	Embalaje
200405005	Máx. 10W	○ Blanco mate	Ø84x25mm	Ø75mm	20/100
200405006	Máx. 10W	● Negro mate	Ø84x25mm	Ø75mm	20/100



A Basculante / Redondo



B Basculante / Redondo



C Basculante / Cuadrado

Aros basculantes empotrables

Para lámparas microicas. **Portalámparas GU10 incluido.** Material: **aluminio.**

Referencia	Artículo	Tipo	Forma	Potencia	Color	Dimensión	Empotr.	Embalaje
000705226	A	Basculante	Redonda	Máx. 50W	○ Blanco	Ø100x25mm	Ø72mm	10/100
000705227	B	Basculante	Redonda	Máx. 50W	○ Blanco	Ø105x33mm	Ø90mm	10/100
000705229	C	Basculante	Cuadrada	Máx. 50W	○ Blanco	105x105x33mm	90x90mm	10/100



Aro basculante empotrable 360°

Tipo: **basculante**. Forma: **cuadrada**. Material: **aluminio**.
Para lámparas dicroicas. **Portalámparas GU10 incluido**.

Referencia	Potencia	Color	Dimensión	Empotramiento	Embalaje
000705230	Máx. 50W	○ Blanco	110x110x55mm	97x97mm	5/50

Taitu SERIE



Aros fijos empotrables anti deslumbramiento

Tipo: **fijo**. Color: **blanco mate**.
Para lámparas dicroicas. Material: **aluminio**. **Portalámparas GU10 incluido**. IP20.

Referencia	Potencia	Forma	Dimensión	Empotramiento	Embalaje
200405007	Máx. 10W	Redonda	Ø82x65mm	Ø72x65mm	20/100
200405008	Máx. 10W	Cuadrada	88x88x70mm	Ø78x70mm	20/100

Pawne

ARO



Aro empotrable anti deslumbramiento

Tipo: **fijo empotrable**. Material: **aluminio**.
Para lámparas dicroicas. **Portalámparas GU10 incluido**.

Referencia	Potencia	Dimensión	Empotramiento	Embalaje
200405001	Máx. 50W	Ø90x45mm	Ø75mm	10/100

Osages

ARO



Especial
para baños



IP44

Aro empotrable

Tipo: **fijo empotrable**. Material: **aluminio**. Para lámparas dicroicas. **Portalámparas GU10 incluido**.
Bombilla no incluida. Altura de bombilla una vez instalada: 80mm. No aconsejable para techos muy bajos.

Referencia	Potencia	Dimensión	Empotramiento	Embalaje
200405002	Máx. 50W	Ø84x55mm	Ø75mm	10/100

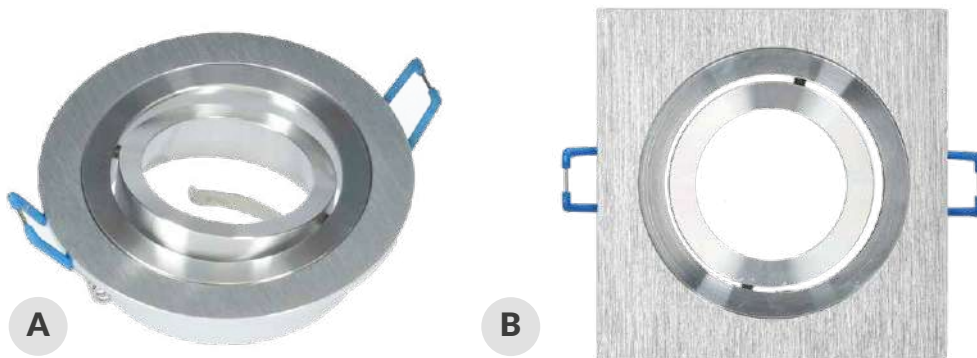

Aros basculantes

Empotrable liso. Para lámparas microicas. **Portalámparas GU10 incluido.**
Color: níquel satín. Potencia: máx. 50W. Material: **aluminio.**

Referencia	Artículo	Forma	Potencia	Dimensión	Empotramiento	Embalaje
000701952	A	Redondo	Máx. 50W	Ø90mm	Ø75mm	10/100
000701953	B	Cuadrado	Máx. 50W	90x90mm	75x75mm	100

Danbi

ARO

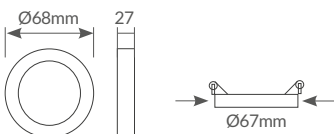
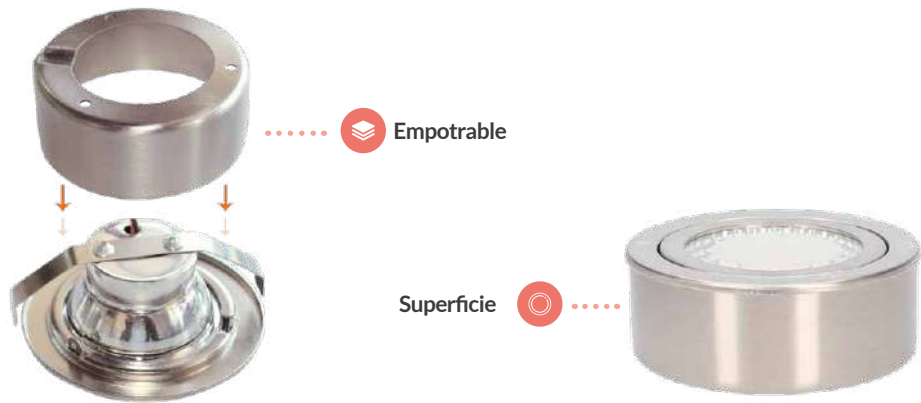

- 3000K
- 6000K
- 80°
- 100.000
- ≥80Ra
- 30.000h.
- 110-260V
- 50Hz

Aro redondo LED SMD

Desmontable **empotrable / superficie.** LED driver incluido. Color: **níquel satín.**

Referencia	Potencia	Lúmenes	Luz	Embalaje
200400008	3W	300Lm	3000K	200
200400009	3W	300Lm	6000K	200

Lumati

SERIE

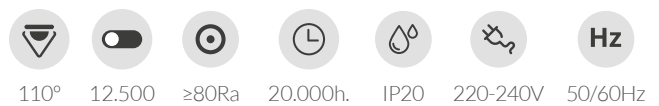
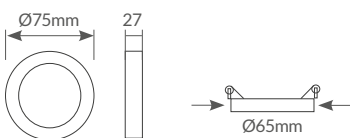
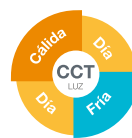

Aro redondo LED empotrable compacto

Cambio de tonalidad de luz a través de un botón. Material: **PP + PS**. LED driver incluido. Uso interior. Longitud cable: 100mm. Su **diseño compacto** permite instalarlos en techos como el pladur donde no hay mucho espacio con el techo.

Referencia	Artículo	Potencia	Lúmenes (360°)	Luz	Color	Embalaje
200400010	A	4W	350Lm	CCT (3000-4000-6000K)	○ Blanco	100
200400011	B	4W	350Lm	CCT (3000-4000-6000K)	● Negro	100
200400012	A	7W	600Lm	CCT (3000-4000-6000K)	○ Blanco	100
200400013	B	7W	600Lm	CCT (3000-4000-6000K)	● Negro	100

Lúbia





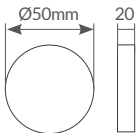
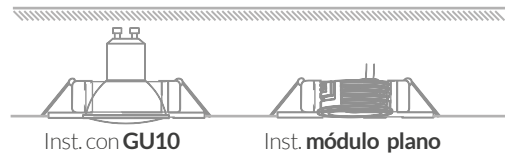

MÓDULO LED

 Ideal **espacios reducidos**



60°



-  3000K
-  4000K
-  6000K
-  15.000
-  ≥80Ra
-  25.000h.
-  220-240V

Módulo LED plano para focos y aros empotrables 60°

Tipo: **fijo empotrable**. Material: **cerámico**. Ideal para **espacios reducidos** donde no caben bombillas GU10. Longitud cable: 100mm.

Referencia	Potencia	Lúmenes útiles (90°)	Lúmenes nominales (360°)	Luz	Ángulo apertura	Embalaje
200621060	6.5W	510Lm	640Lm	 3000K	60°	10/100
200621061	6.5W	510Lm	640Lm	 4000K	60°	10/100
200621062	6.5W	510Lm	640Lm	 6000K	60°	10/100

Andulo

MÓDULO LED



Ideal **espacios reducidos**





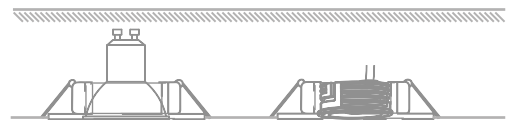



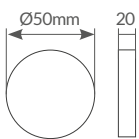

120°



Inst. con **GU10**



Inst. **módulo plano**



-  3000K
-  4000K
-  6000K
-  15.000
-  ≥80Ra
-  25.000h.
-  220-240V

Módulo LED plano para focos y aros empotrables 120°

Tipo: **fijo empotrable**. Material: **cerámico**. Ideal para **espacios reducidos** donde no caben bombillas GU10. Longitud cable: 100mm.

Referencia	Potencia	Lúmenes	Luz	Ángulo apertura	Embalaje
200621063	6.5W	600Lm	 3000K	120°	10/100
200621064	6.5W	600Lm	 4000K	120°	10/100
200621065	6.5W	600Lm	 6000K	120°	10/100

Banok

SERIE



A



B



C



D

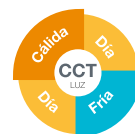
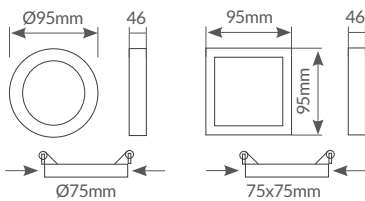

60°



15.000



≥80Ra



25.000h.



IP44



220-240V



50/60Hz

Aro basculante empotrable LED COB

Cambio de tonalidad de luz a través de un botón. Material: **plástico**. LED driver incluido.

Referencia	Artículo	Forma	Potencia	Lúmenes útiles (90°)	Lúmenes nominales (360°)	Luz	Color	Emb.
200400000	A	Redonda	7W	650Lm	740Lm	CCT (3000-4000-6500K)	○ Blanco	100
200400002	B	Redonda	7W	650Lm	740Lm	CCT (3000-4000-6500K)	● Negro	100
200400001	C	Cuadrada	7W	650Lm	740Lm	CCT (3000-4000-6500K)	○ Blanco	100
200400003	D	Cuadrada	7W	650Lm	740Lm	CCT (3000-4000-6500K)	● Negro	100

Mandani

SERIE



A



B



Antideslumbramiento

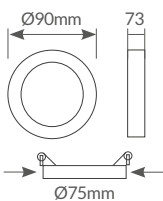
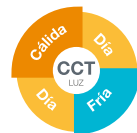

70°



15.000



≥80Ra



25.000h.



IP44



170-240V



50/60Hz

Aro empotrable LED COB

Cambio de tonalidad de luz a través de un botón. Material: **plástico**. LED driver incluido. Uso interior.

Referencia	Artículo	Forma	Potencia	Lúmenes útiles (90°)	Lúmenes nominales (360°)	Luz	Color	Emb.
200400014	A	Redonda	7W	550Lm	650Lm	CCT (3000-4000-6500K)	○ Blanco	100
200400015	B	Redonda	7W	550Lm	650Lm	CCT (3000-4000-6500K)	● Negro	100

Belur

EMPOTRABLE

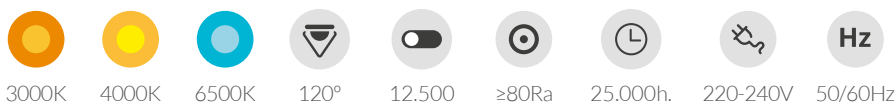
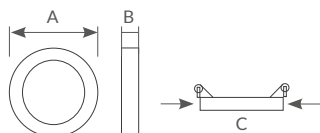

Downlight redondo empotrable de LED

Forma: **redonda**. LED driver incluido. Material: **PA + PS**. Color: blanco. Uso interior. IP40. IK02.

Referencia	Con difusor / Luminaria (360°)	Sin difusor / Fuente de luz (360°)	Luz	Dimensión (AxB)	Empotramiento (C)	Embalaje
201000037	6W / 540Lm	6W / 600Lm	● 4000K	Ø120x23mm	Ø100-110mm	40
201000038	6W / 540Lm	6W / 600Lm	● 6500K	Ø120x23mm	Ø100-110mm	40
201000039	9W / 720Lm	9W / 850Lm	● 4000K	Ø150x23mm	Ø120-135mm	40
201000040	9W / 720Lm	9W / 850Lm	● 6500K	Ø150x23mm	Ø120-135mm	40
201000041	12W / 960Lm	12W / 1200Lm	● 4000K	Ø170x23mm	Ø140-160mm	40
201000042	12W / 960Lm	12W / 1200Lm	● 6500K	Ø170x23mm	Ø140-160mm	40
201000043	18W / 1440Lm	18W / 1850Lm	● 3000K	Ø225x23mm	Ø195-210mm	20
201000044	18W / 1440Lm	18W / 1850Lm	● 4000K	Ø225x23mm	Ø195-210mm	20
201000045	18W / 1440Lm	18W / 1850Lm	● 6500K	Ø225x23mm	Ø195-210mm	20
201000046	24W / 1920Lm	24W / 2500Lm	● 4000K	Ø225x23mm	Ø195-210mm	20
201000047	24W / 1920Lm	24W / 2500Lm	● 6500K	Ø225x23mm	Ø195-210mm	20

Belur

EMPOTRABLE



18W

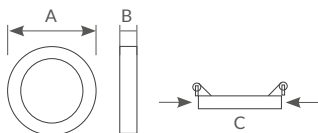

4000K



6500K



120°



12.500



≥80Ra



25.000h.



220-240V



50/60Hz

Downlight redondo empotrable de LED

Forma: **redonda**. LED driver incluido. Material: **PA + PS**. Color: blanco. Uso interior. IP40. IK02.

Referencia	Con difusor / Luminaria (360°)	Sin difusor / Fuente de luz (360°)	Luz	Color	Dimensión (AxB)	Empotramiento (C)	Emb.
201000062	18W / 1440Lm	18W / 1850Lm	● 4000K	● Gris	Ø225x23mm	Ø195-210mm	20
201000063	18W / 1440Lm	18W / 1850Lm	● 6500K	● Gris	Ø225x23mm	Ø195-210mm	20
201000065	18W / 1440Lm	18W / 1850Lm	● 4000K	● Negro	Ø225x23mm	Ø195-210mm	20
201000064	18W / 1440Lm	18W / 1850Lm	● 6500K	● Negro	Ø225x23mm	Ø195-210mm	20

Virey

EMPOTRABLE

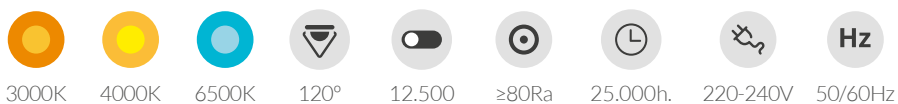
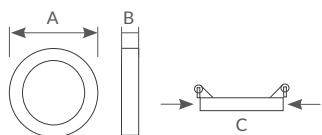
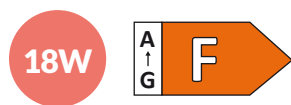

Downlight redondo empotrable de LED

Forma: **redonda**. LED driver incluido. Material: **aluminio + PS**. Color: blanco. Uso interior. IP40. IK02.

Referencia	Con difusor / Luminaria (360°)	Sin difusor / Fuente de luz (360°)	Luz	Dimensión (Ax B)	Empotramiento (C)	Embalaje
201000066	18W / 1440Lm	18W / 1800Lm	● 3000K	Ø225x13mm	Ø205mm	20
201000067	18W / 1440Lm	18W / 1800Lm	● 4000K	Ø225x13mm	Ø205mm	20
201000068	18W / 1440Lm	18W / 1800Lm	● 6500K	Ø225x13mm	Ø205mm	20

Lonbo
EMPOTRABLE

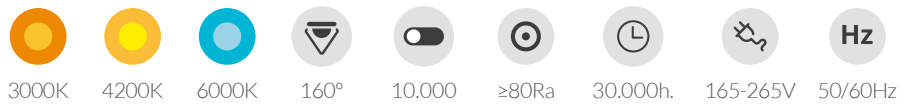
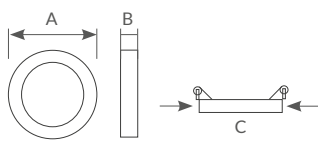
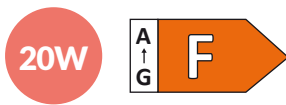

Downlight redondo empotrable de LED







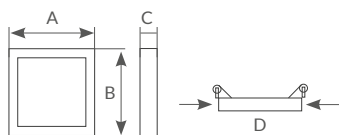
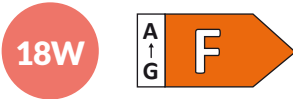

Forma: **redonda**. LED driver incluido. Material: **aluminio + PS**. Color: blanco. Uso interior. **PF0.9**. IK02.

Referencia	Con difusor / Luminaria (360°)	Sin difusor / Fuente de luz (360°)	Luz	Dimensión (AxB)	Empotramiento (C)	Embalaje
201000080	20W / 1810Lm	20W / 2100Lm	● 3000K	Ø240x13mm	Ø225mm	20
201000076	20W / 1810Lm	20W / 2100Lm	● 4200K	Ø240x13mm	Ø225mm	20
201000077	20W / 1810Lm	20W / 2100Lm	● 6000K	Ø240x13mm	Ø225mm	20
201095004	Recambio driver para downlight Lonbo ref. 201000076 - 77					

Londa



EMPOTRABLE



-  4000K
-  6500K
-  120°
-  12.500
-  ≥80Ra
-  25.000h.
-  220-240V
-  50/60Hz

Downlight cuadrado empotrable de LED

Forma: **cuadrada**. LED driver incluido. Material: **PC + PS**. Color: blanco. Uso interior. IP40. IK02.

Referencia	Con difusor / Luminaria (360°)	Sin difusor / Fuente de luz (360°)	Luz	Dimensión (AxBxC)	Empotramiento (D)	Embalaje
201000048	18W / 1440Lm	18W / 1850Lm	 4000K	225x225x24mm	208x208mm	20
201000049	18W / 1440Lm	18W / 1850Lm	 6500K	225x225x24mm	208x208mm	20

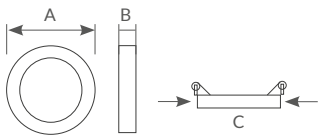
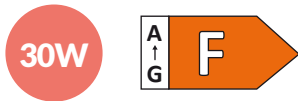

Downlight redondo empotrable LED

Forma: **redonda**. LED driver incluido. Material: **PC + aluminio**. Color: blanco. Uso interior. **IK05**.

Referencia	Potencia	Lúmenes	Luz	Dimensión (AxB)	Empotramiento	Embalaje
201000029	30W	3280Lm	● 4200K	Ø230x60mm	Ø200mm	10
201000070	30W	3280Lm	● 5500K	Ø230x60mm	Ø200mm	10

Aketi

EMPOTRABLE

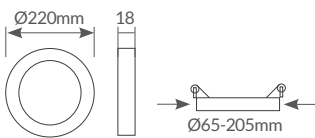
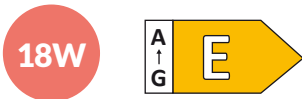

Downlight empotrable LED regulable con sensor

Forma: **redonda**. Downlight **empotrable o de superficie**.
Empotramiento regulable. Desde Ø65mm hasta Ø205mm. **Se adapta a diversos tamaños de agujeros**.
Temperatura regulable a través de botón. **Tiempo no regulable**: está encendido durante 30seg.
Sensor movimiento + fotoeléctrica: puede funcionar sólo de noche o de día y de noche.
Radio de detección: 3.5M (instalado en altura de 2.8M). LED driver incluido. Color: blanco. IK04.
 Consumo stand-by: <0.5W. Material: **PC + Aluminio**.

Referencia	Con difusor / Luminaria (360°)	Sin difusor / Fuente de luz (360°)	Luz	Embalaje
201010006	18W / 1550Lm	18W / 1970Lm	3000K - 4000K - 6500K	20

* Consulta el esquema de detección en el apartado info técnica.

Larissa

EMPOTRABLE



Interior Downlights



18W **36W**

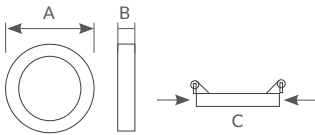

- 4200K
- 6500K
- 180°
- 15.000
- ≥80Ra
- 15.000h.
- 220-240V
- Hz

Downlight empotrable LED regulable

Forma: **redonda**. Empotramiento regulable. Se adapta a diversos tamaños de agujeros.
LED driver incluido. Material: **aluminio**. Color: blanco. Uso interior.

Referencia	Con difusor / Luminaria (360°)	Sin difusor / Fuente de luz (360°)	Luz	Dimensión (AxB)	Empotramiento (C)	Embalaje
201000031	18W / 1646Lm	18W / 1867Lm	4200K	Ø120x22mm	Ø75-105mm (Reg.)	40
201000032	18W / 1646Lm	18W / 1867Lm	6500K	Ø120x22mm	Ø75-105mm (Reg.)	40
201000033	Recambio driver 18W					
201000034	36W / 3475Lm	36W / 4255Lm	4200K	Ø225x22mm	Ø75-205mm (Reg.)	20
201000035	36W / 3475Lm	36W / 4255Lm	6500K	Ø225x22mm	Ø75-205mm (Reg.)	20
201000036	Recambio driver 36W					

Nevale

EMPOTRABLE



20W

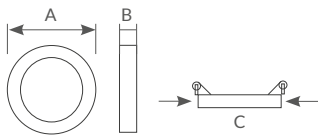

4200K



6000K



160°



10.000



≥80Ra



25.000h.



180-265V



50/60Hz

Empotramiento regulable

Interior Downlights

Downlight redondo empotrable LED regulable

Forma: **redonda**. Empotramiento regulable. Se adapta a diversos tamaños de agujeros.
LED driver incluido. Material: **aluminio**. Color: blanco. Uso interior.

Referencia	Potencia	Lúmenes	Luz	Dimensión (AxB)	Empotramiento	Embalaje
201000072	20W	2050Lm	● 4200K	Ø230x20mm	Ø50-210mm (Reg.)	20
201000073	20W	2050Lm	● 6000K	Ø230x20mm	Ø50-210mm (Reg.)	20
201095001	Recambio driver 20W					

Bogur
SUPERFICIE



6W

12W

18W

24W

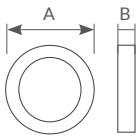

4000K



6500K



120°



12.500



≥80Ra



25.000h.



220-240V



50/60Hz

Downlight redondo superficie de LED

Forma: **redonda**. LED driver incluido. Material: **PA + PS**. Color: blanco. Uso interior. IP40. IK02.

Referencia	Con difusor / Luminaria (360°)	Sin difusor / Fuente de luz (360°)	Luz	Dimensión (AxBxC)	Embalaje
201005019	6W / 540Lm	6W / 600Lm	● 4000K	Ø120x28mm	40
201005020	6W / 540Lm	6W / 600Lm	● 6500K	Ø120x28mm	40
201005021	12W / 960Lm	12W / 1200Lm	● 4000K	Ø170x28mm	40
201005022	12W / 960Lm	12W / 1200Lm	● 6500K	Ø170x28mm	40
201005023	18W / 1440Lm	18W / 1850Lm	● 4000K	Ø225x28mm	20
201005024	18W / 1440Lm	18W / 1850Lm	● 6500K	Ø225x28mm	20
201005025	24W / 1920Lm	24W / 2500Lm	● 4000K	Ø225x28mm	20
201005026	24W / 1920Lm	24W / 2500Lm	● 6500K	Ø225x28mm	20

Vasan
SUPERFICIE

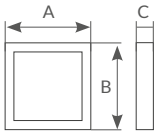
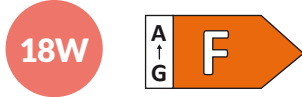

4000K



6500K



120°



12.500



≥80Ra



25.000h.



220-240V



50/60Hz

Downlight cuadrado superficie de LED

Forma: **cuadrado**. LED driver incluido. Material: **PC + PS**. Color: blanco. Uso interior. IP40. IK02.

Referencia	Con difusor / Luminaria (360°)	Sin difusor / Fuente de luz (360°)	Luz	Dimensión (AxBxC)	Embalaje
201005027	18W / 1440Lm	18W / 1850Lm	● 4000K	225x225x28mm	20
201005028	18W / 1440Lm	18W / 1850Lm	● 6500K	225x225x28mm	20

Gemena
SUPERFICIE

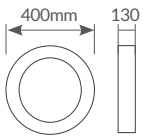

IP20



220-240V



50/60Hz

Plafón techo de tela 2xE27

Forma: **redonda**. Material: **tela + base metálica + difusor PC**. Uso interior.





Referencia	Potencia	Casquillo	Color	Embalaje
203600001	Máx. 60W	2xE27	○ Blanco	2
203600002	Máx. 60W	2xE27	● Negro	2
203600003	Máx. 60W	2xE27	● Celeste	2
203600004	Máx. 60W	2xE27	● Azul	2
203600005	Máx. 60W	2xE27	● Lavanda	2

Kasker
SUPERFICIE

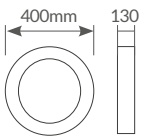
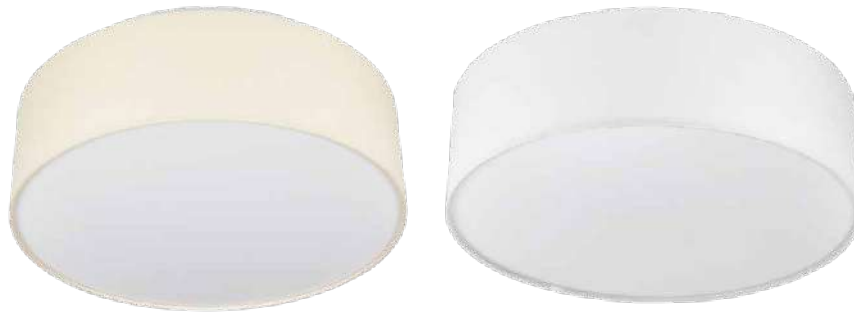

22W



-  120°
-  100.000
-  ≥80Ra
-  25.000h.
-  IP20
-  220-240V
-  Hz

Plafón techo LED regulable

Forma: **redonda**. LED driver incluido. **Temperatura e intensidad regulable.**
 Con **memoria del último estado de color.**
Temporizador 30°. Modo noche. Incluye mando (utiliza 2 pilas AAA, incluidas).
 Material: **tela + base metálica + difusor PC.** Uso interior.

Referencia	Con difusor / Luminaria	Sin difusor / Fuente de luz (360°)	Luz	Color	Embalaje
203605069	22W / 900Lm	22W / 2000Lm	3000K - 6500K	● Gris	2
203605070	22W / 900Lm	22W / 2000Lm	3000K - 6500K	● Beige	2
203605071	22W / 900Lm	22W / 2000Lm	3000K - 6500K	○ Blanco	2

Elda
SUPERFICIE



Interior Plafones

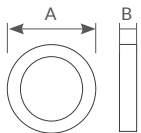

Plafón techo de LED

Forma: **redonda**. LED driver incluido. Material: **plástico**. Color: blanco. Uso interior.

Referencia	Con difusor / Luminaria (360°)	Sin difusor / Fuente de luz (360°)	Luz	Dimensión (AxB)	Embalaje
203605041	14W / 1190Lm	14W / 1380Lm	● 3000K	Ø260x65mm	10
203605042	14W / 1190Lm	14W / 1380Lm	● 4000K	Ø260x65mm	10
203605043	14W / 1190Lm	14W / 1380Lm	● 6500K	Ø260x65mm	10
203605044	20W / 1600Lm	20W / 2050Lm	● 3000K	Ø290x65mm	10
203605045	20W / 1600Lm	20W / 2050Lm	● 4000K	Ø290x65mm	10
203605046	20W / 1600Lm	20W / 2050Lm	● 6500K	Ø290x65mm	10
203605047	24W / 1920Lm	20W / 2500Lm	● 3000K	Ø340x65mm	10
203605048	24W / 1920Lm	20W / 2500Lm	● 4000K	Ø340x65mm	10
203605049	24W / 1920Lm	20W / 2500Lm	● 6500K	Ø340x65mm	10



Birai
SUPERFICIE

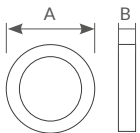

Plafón techo de LED

Forma: **redonda**. LED driver incluido. Material: **metal + PMMA**. Color: blanco. Uso interior.

Referencia	Con difusor / Luminaria (360°)	Sin difusor / Fuente de luz (360°)	Luz	Dimensión (AxB)	Embalaje
203605089	12W / 900Lm	12W / 1160Lm	● 3000K	Ø260x75mm	10
203605090	12W / 900Lm	12W / 1160Lm	● 4000K	Ø260x75mm	10
203605091	12W / 900Lm	12W / 1160Lm	● 6500K	Ø260x75mm	10
203605092	18W / 1350Lm	18W / 1820Lm	● 3000K	Ø310x95mm	10
203605093	18W / 1350Lm	18W / 1820Lm	● 4000K	Ø310x95mm	10
203605094	18W / 1350Lm	18W / 1820Lm	● 6500K	Ø310x95mm	10
203605095	24W / 1800Lm	24W / 2500Lm	● 3000K	Ø350x95mm	10
203605096	24W / 1800Lm	24W / 2500Lm	● 4000K	Ø350x95mm	10
203605097	24W / 1800Lm	24W / 2500Lm	● 6500K	Ø350x95mm	10

Andra
SUPERFICIE

Interior Plafones

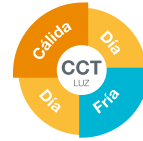

24W 30W

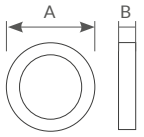

- 180°
- 15.000
- ≥80Ra
- 25.000h.
- IP44
- 220-240V
- 50/60Hz

Plafón techo LED

Forma: **redonda**. LED driver incluido.
Temperatura regulable: de 3000K a 6500K ofrece 10 tonalidades diferentes.
 Material: **plástico**. Uso interior.

Referencia	Con difusor / Luminaria	Sin difusor / Fuente de luz (360°)	Luz	Color	Dimensión (AxB)	Emb.
203605072	24W/ 1875Lm	24W/ 2500Lm	3000K - 6500K	● Negro	Ø295x55mm	6
203605073	24W/ 1875Lm	24W/ 2500Lm	3000K - 6500K	● Efecto madera	Ø295x55mm	6
203605074	30W/ 2400Lm	30W/ 3200Lm	3000K - 6500K	● Negro	Ø420x60mm	6
203605075	30W/ 2400Lm	30W/ 3200Lm	3000K - 6500K	● Efecto madera	Ø420x60mm	6

Andra
SUPERFICIE

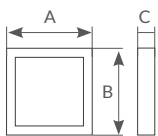
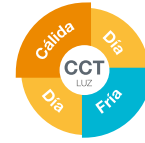

180°



15.000



≥80Ra



25.000h.



IP44



220-240V



50/60Hz

Plafón techo LED

Forma: **cuadrada**. LED driver incluido.

Temperatura regulable: de 3000K a 6500K ofrece 10 tonalidades diferentes.

Material: **plástico**. Uso interior.

Referencia	Con difusor / Luminaria	Sin difusor / Fuente de luz (360°)	Luz	Color	Dimensión (Ax B)	Embalaje
203605076	30W / 2400Lm	30W / 3200Lm	3000K - 6500K	● Negro	420x420x55mm	6

Melun

SUPERFICIE

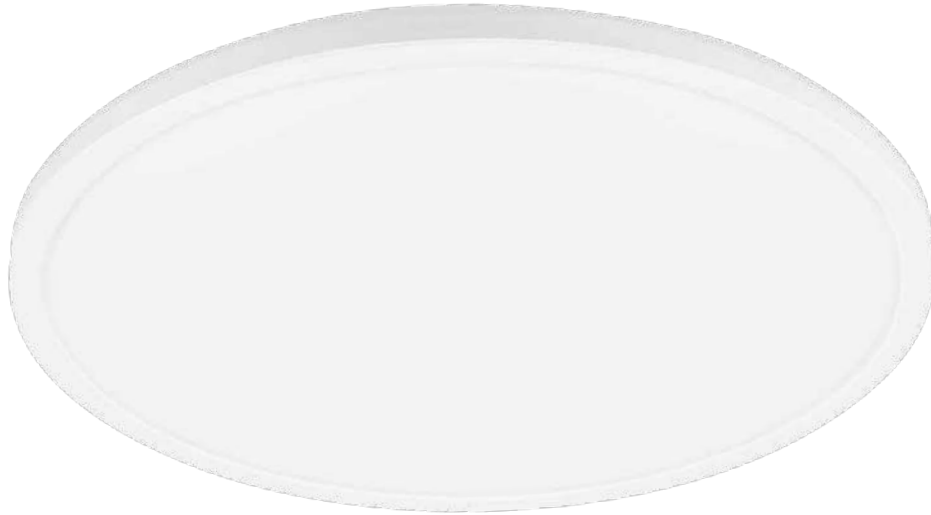

Interior Plafones

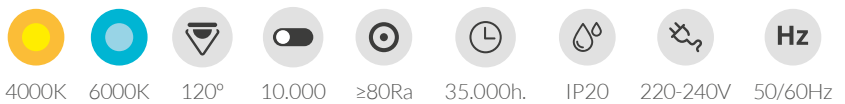
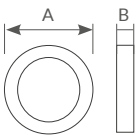

Plafón techo de LED

Forma: **redonda**. LED driver incluido. Material: **plástico**. Color: blanco. Uso interior.
Efecto luz indirecta sobre el techo gracias a la parte transparente superior.

Referencia	Con difusor / Luminaria	Sin difusor / Fuente de luz (360°)	Luz	Dimensión (AxB)	Embalaje
203605037	19.5W / 1800Lm	17.5W / 2200Lm	● 4000K	Ø293x28.5mm	6
203605038	19.5W / 1800Lm	17.5W / 2200Lm	● 6000K	Ø293x28.5mm	6
203605039	22W / 2500Lm	21W / 3000Lm	● 4000K	Ø420x28.5mm	6
203605040	22W / 2500Lm	21W / 3000Lm	● 6000K	Ø420x28.5mm	6

Simola
SUPERFICIE







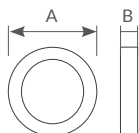

46W



LIFUD
LED Driver



-  4000K
-  120°
-  25.000
-  PF≥0.9
-  ≥80Ra
-  30.000h.
-  IP20
-  220V
-  Hz

Plafón techo redondo LED

Forma: **redonda**. LED driver incluido. Material: **hierro y acrílico**. Uso interior.

Referencia	Con difusor / Luminaria	Sin difusor / Fuente de luz (360°)	Luz	Color	Dimensión (AxB)	Embalaje
203605077	46W / 3306Lm	46W / 6000Lm	● 4000K	○ Blanco	Ø610x85mm	1
203605078	46W / 3306Lm	46W / 6000Lm	● 4000K	● Gris	Ø610x85mm	1
203615001	Recambio driver para plafón Simola ref. 203605077 - 78 - 79					

Simola
SUPERFICIE



LIFUD
LED Driver

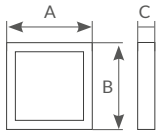

4000K



120°



25.000



PF ≥ 0.9



≥ 80Ra



30.000h.



IP20



220V



50Hz

Plafón techo cuadrado LED

Forma: **cuadrada**. LED driver incluido. Material: **hierro y acrílico**. Uso interior.

Referencia	Con difusor / Luminaria	Sin difusor / Fuente de luz (360°)	Luz	Color	Dimensión (AxB)	Embalaje
203605079	51W/3113Lm	51W/5724Lm	● 4000K	○ Blanco	625x625x85mm	1
203615001	Recambio driver para plafón Simola ref. 203605077 - 78 - 79					

Kataja
SUPERFICIE



32W

65W

82W



65W



65W

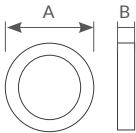

4000K



120°



25.000



PF ≥ 0.9



≥ 80Ra



30.000h.



IP20



220V



50Hz

Plafón techo redondo LED

Forma: **redonda**. LED driver incluido. Material: **hierro y acrílico** (blanco y negro), **aluminio y acrílico** (dorado). Uso interior.

Referencia	Con difusor / Luminaria	Sin difusor / Fuente de luz (360°)	Luz	Color	Dimensión (Ax B)	Embalaje
203605080	32W / 2355Lm	32W / 3564Lm	● 4000K	○ Blanco	Ø400x60mm	1
203605081	65W / 4817Lm	65W / 7344Lm	● 4000K	○ Blanco	Ø600x60mm	1
203605082	65W / 4817Lm	65W / 7344Lm	● 4000K	● Negro	Ø600x60mm	1
203605083	65W / 4817Lm	65W / 7344Lm	● 4000K	● Dorado	Ø600x60mm	1
203605084	82W / 6948Lm	82W / 9202Lm	● 4000K	○ Blanco	Ø800x60mm	1
203615002	Recambio driver para plafón Kataja ref. 203605080 - 81 - 82 - 83					
203615003	Recambio driver para plafón Kataja ref. 203605084					

Peranka

SUPERFICIE

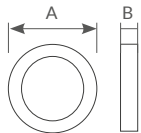

- 4000K
- 120°
- 25.000
- PF ≥ 0.9
- ≥ 80Ra
- 30.000h.
- IP20
- 220V
- 50Hz

Plafón techo **redondo LED**

Forma: **redonda**. LED driver incluido. Material: **aluminio, metal y acrílico**. Uso interior.

Referencia	Con difusor / Luminaria	Sin difusor / Fuente de luz (360°)	Luz	Color	Dimensión (AxB)	Emb.
203605085	42W / 2250Lm	42W / 4708Lm	● 4000K	○ Blanco + Efecto madera	Ø450x110mm	1
203605086	42W / 2250Lm	42W / 4708Lm	● 4000K	● Negro + Efecto madera	Ø450x110mm	1
203605087	65W / 3446Lm	32W / 7208Lm	● 4000K	○ Blanco + Efecto madera	Ø600x110mm	1
203605088	65W / 3446Lm	32W / 7208Lm	● 4000K	● Negro + Efecto madera	Ø600x110mm	1
203615004	Recambio driver para plafón Peranka ref. 203605085 - 86					
203615005	Recambio driver para plafón Peranka ref. 203605087 - 88					

Austra

SUPERFICIE

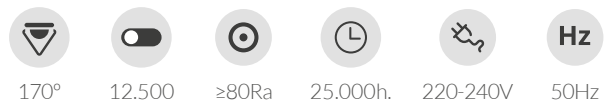
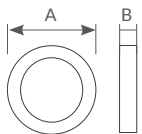
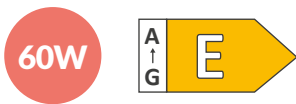

Plafón techo LED regulable

LED driver incluido. Material: **plástico**. Color: blanco. Uso interior.

Regulable en intensidad. Con mando a distancia (3 x AAA incl.).

Regulable en temperatura de color: 3000K / 4000K / 6500K o de forma gradual.

Con **memoria** del último estado de color.

Referencia	Con difusor / Luminaria	Sin difusor / Fuente de luz (360°)	Luz	Dimensión (AxB)	Embalaje
203605059	60W / 5100Lm (3000K) 60W / 5700Lm (4000K) 60W / 5100Lm (6500K)	60W / 6650Lm (4000K)	CCT	Ø500x80mm	5

Bogen
SUPERFICIE

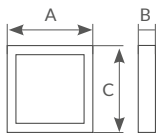

3000K



4200K



6000K



170°



12.500



≥80Ra



25.000h.



IP20



220-240V



50Hz

Plafón techo de LED

Forma: **cuadrada**. LED driver incluido. Material: **plástico**. **PF: 0.9**. Color: blanco. Uso interior.

Referencia	Con difusor / Luminaria (360°)	Sin difusor / Fuente de luz (360°)	Luz	Dimensión (AxB)	Embalaje
203605050	20W / 1600Lm	20W / 2050Lm	● 3000K	280x280x65mm	10
203605051	20W / 1600Lm	20W / 2050Lm	● 4000K	280x280x65mm	10
203605052	20W / 1600Lm	20W / 2050Lm	● 6500K	280x280x65mm	10
203605053	32W / 2560Lm	32W / 3380Lm	● 3000K	330x330x65mm	10
203605054	32W / 2560Lm	32W / 3380Lm	● 4000K	330x330x65mm	10
203605055	32W / 2560Lm	32W / 3380Lm	● 6500K	330x330x65mm	10
203605056	42W / 3570Lm	42W / 4490Lm	● 3000K	430x430x65mm	10
203605057	42W / 3570Lm	42W / 4490Lm	● 4000K	430x430x65mm	10
203605058	42W / 3570Lm	42W / 4490Lm	● 6500K	430x430x65mm	10

Kigoma

PLAFÓN TECHO

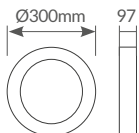

IP20



220-240V



50/60Hz

Plafón techo con sensor

Forma: **redonda**. Material: **PC**. Color: blanco. Uso interior.

Tiempo regulable: 10seg. ± 3seg. a 3min ± 3seg. **Máx. distancia detección:** 6M.

Luz ambiental: <3-2000lux (regulable). **Temperatura de funcionamiento:** -20°C+40°C.

Altura instalación: 2.2-4M. **Consumo stand-by:** 0.5W. Bombillas no incluidas.

Referencia	Potencia	Casquillo	Color	Embalaje
203610009	Máx. 2x25W	2xE27	○ Blanco	5

Bagori
SUPERFICIE



16W

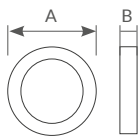

3000K



6000K



120°



20.000



≥80Ra



30.000h.



IP20



110-240V



50/60Hz

Plafón techo LED + sensor movimiento

Forma: **redonda**. LED driver incluido. Material: **plástico**. Color: blanco. Uso interior.
Tiempo regulable: 10seg. ± 3seg. a 5min ± 3seg. **Máx. distancia detección:** 9M (radio). **Luz ambiental:** 3-2000lux (regulable).
Temperatura de funcionamiento: -20°C+40°C. **Altura instalación:** 2.2-4M. **Consumo stand-by:** 0.45W.

Referencia	Con difusor / Luminaria	Sin difusor / Fuente de luz (360°)	Luz	Dimensión (Ax B)	Embalaje
203610002	16W / 1150Lm	15W / 1800Lm	● 3000K	Ø290x60mm	10
203610003	16W / 1150Lm	15W / 1800Lm	● 6000K	Ø290x60mm	10

Bamil

SERIE



A



B

* Bombillas no incluidas.

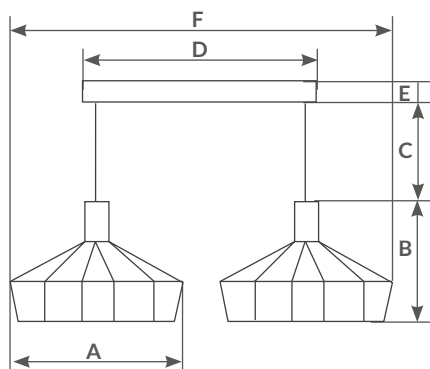
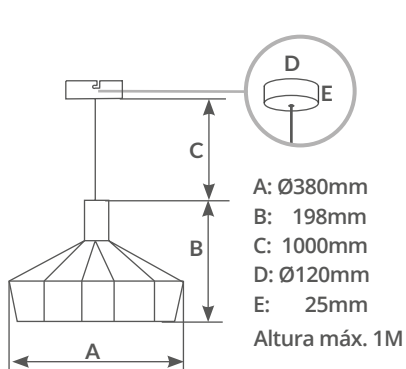

Incluye kit para colgar

Lámparas colgantes



IP20



220-240V



50Hz

Altura regulable. Incluye accesorios para colgar.

Referencia	Artículo	Tipo	Potencia	Casquillo	Color	Material	Embalaje
204400025	A	Simple	Máx. 40W	E27	● Negro	Metal	1
204400026	B	Doble	Máx. 40W	E27	● Negro	Metal	1



Interior Lámparas colgantes

Industrial LÁMPARA TECHO

Diamond LÁMPARA TECHO



A



B

* Bombillas no incluidas.

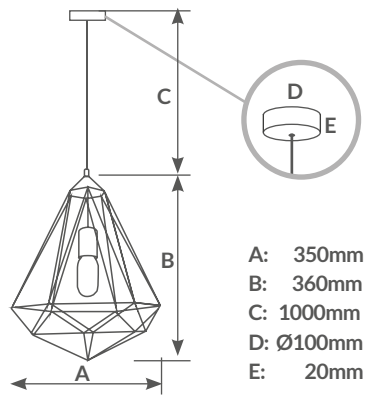
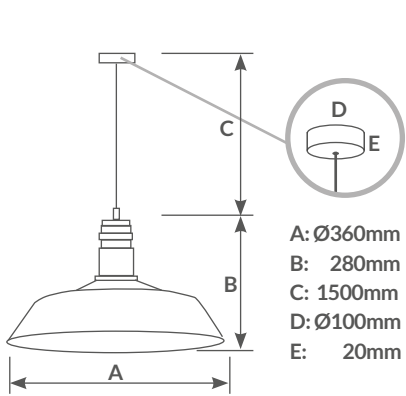

Altura regulable
Altura máx. 1M / 1.5M



Incluye
kit para colgar

Lámparas colgantes



IP20



220-240V



50/60Hz

Incluye accesorios para colgar.

Referencia	Artículo	Potencia	Casquillo	Color	Material	Interior	Cable	Embalaje
000705245	A	Máx. 60W	E27	● Negro	Metal	Blanco	1.5M	1
000705242	B	Máx. 60W	E27	● Negro	Metal	1	1M	1

Jaula
LÁMPARA TECHO

Hub
LÁMPARA TECHO



C



D

* Bombillas no incluidas.

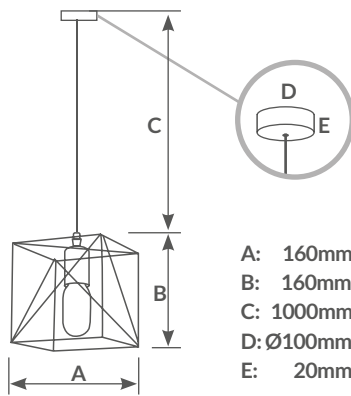
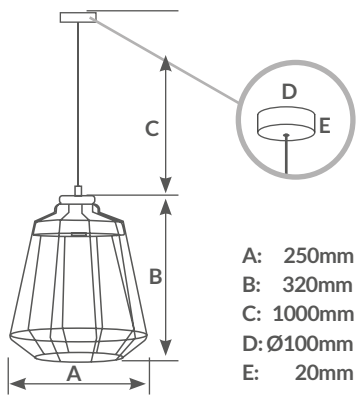

Altura regulable
Altura máx. 1M



Incluye
kit para colgar

Lámparas colgantes



IP20



220-240V



50/60Hz

Incluye accesorios para colgar.

Referencia	Artículo	Potencia	Casquillo	Color	Material	Embalaje
000705241	C	Máx. 60W	E27	● Negro	Metal + Madera	1
000705240	D	Máx. 60W	E27	● Negro	Metal	1

Fundi
SERIE



Interior Lámparas colgantes



A



B

* Bombillas no incluidas.

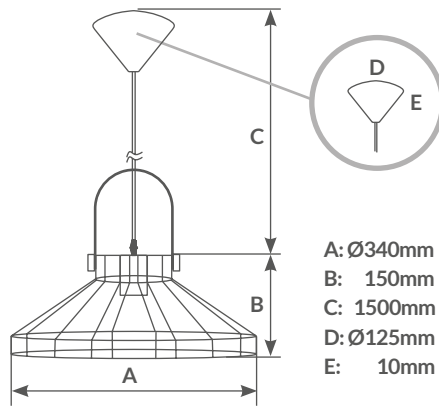
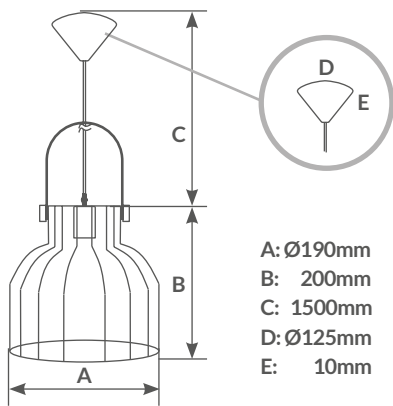

Altura regulable
Altura máx. 1.5M



Incluye
kit para colgar

Lámparas colgantes



IP20



230V



50Hz

Cable: 0.8M. Incluye accesorios para colgar.

Referencia	Artículo	Potencia	Casquillo	Color	Material	Embalaje
204400016	A	Máx. 40W	E27	● Negro + ● Haya	Metal	1
204400017	B	Máx. 40W	E27	● Negro + ● Haya	Metal	1

Fundi
SERIE



C



D

* Bombillas no incluidas.

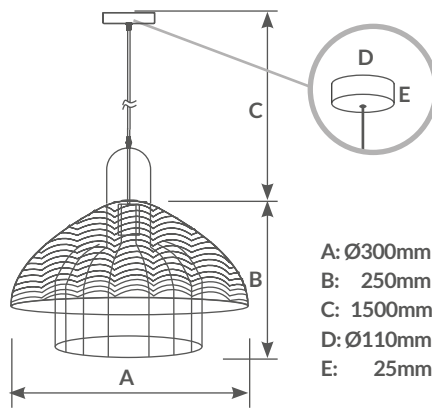
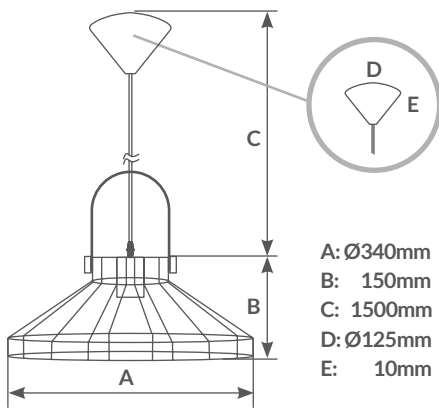

Altura regulable
Altura máx. 1.5M



Incluye
kit para colgar

Lámparas colgantes



IP20



230V



50Hz

Cable: 0.8M. Incluye accesorios para colgar.

Referencia	Artículo	Potencia	Casquillo	Color	Material	Embalaje
204400018	C	Máx. 40W	E27	● Negro + ● Haya	Metal	1
204400019	D	Máx. 40W	E27	● Negro + ● Haya	Metal	1



Kaliab
SERIE



* Bombillas no incluidas.

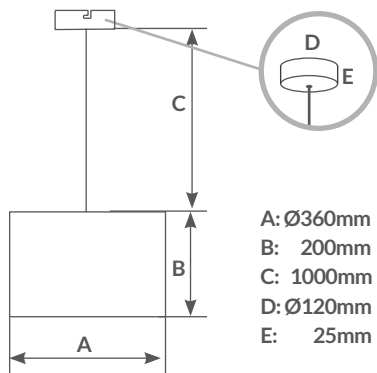

Altura regulable
Altura máx. 1M



Incluye
kit para colgar

Lámparas colgantes



IP20



220-240V



50Hz

Cable: 1M. Incluye accesorios para colgar.

Referencia	Potencia	Casquillo	Color	Material	Embalaje
204400029	Máx. 40W	E27	● Gris	Tela + Metal	1
204400030	Máx. 40W	E27	○ Blanco	Tela + Metal	1
204400031	Máx. 40W	E27	● Azul	Tela + Metal	1
204400032	Máx. 40W	E27	● Verde	Tela + Metal	1

Batwe
SERIE

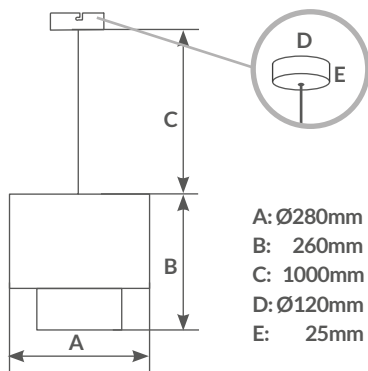

Altura regulable
Altura máx. 1M



Incluye
kit para colgar

* Bombillas no incluidas.

Interior Lámparas colgantes

Lámparas colgantes



IP20



220-240V



50Hz

Cable: 1M. Incluye accesorios para colgar.

Referencia	Potencia	Casquillo	Color	Material	Embalaje
204400033	Máx. 40W	E27	● Gris / Blanco	Tela + Metal	1
204400034	Máx. 40W	E27	○ Blanco	Tela + Metal	1



Sompara

SERIE



* Bombillas no incluidas.

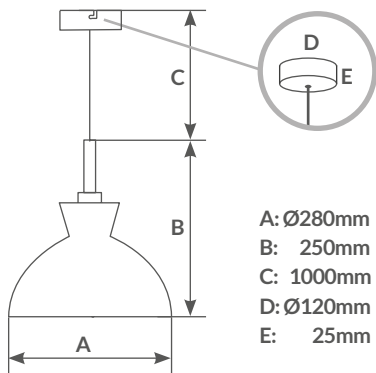

Altura regulable
Altura máx. 1M



Incluye
kit para colgar

Interior Lámparas colgantes

Lámparas colgantes



IP20



220-240V



50Hz

Cable: 1M. Incluye accesorios para colgar.

Referencia	Potencia	Casquillo	Color	Material	Embalaje
204400035	Máx. 40W	E27	● Negro	Metal + Madera	1
204400036	Máx. 40W	E27	○ Blanco	Metal + Madera	1
204400037	Máx. 40W	E27	● Gris	Metal + Madera	1
204400038	Máx. 40W	E27	● Verde	Metal + Madera	1
204400039	Máx. 40W	E27	● Amarillo	Metal + Madera	1
204400040	Máx. 40W	E27	● Rosa	Metal + Madera	1



Barum

LÁMPARA TECHO



* Bombillas no incluidas.

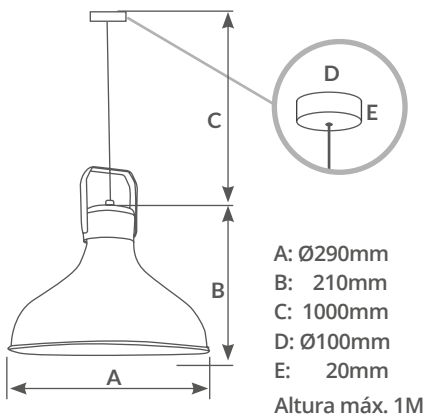

Altura regulable
 Altura máx. 1.5M



Incluye
 kit para colgar

Lámparas colgantes

IP20 230V 50Hz

Altura regulable. Incluye accesorios para colgar.

Referencia	Potencia	Casquillo	Color	Material	Interior	Embalaje
000705252	Máx. 60W	E27	● Cobre	Metal	Blanco	1

Beirut
LÁMPARA



Plástico

A

Origin
LÁMPARA



Aluminio

B

String
LÁMPARA



Aluminio
Con cadena
ON/OFF

C

* Bombillas no incluidas.

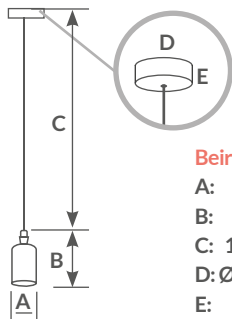

Beirut

A: Ø42mm
B: 62mm
C: 1000mm
D: Ø100mm
E: 20mm

Origin

A: Ø42mm
B: 62mm
C: 1000mm
D: Ø100mm
E: 20mm

String

A: Ø42mm
B: 81mm
C: 1000mm
D: Ø100mm
E: 20mm



Altura regulable
Altura máx. 1M



Incluye
kit para colgar

Lámparas colgantes



IP20



220-240V



Hz

50/60Hz

Cable: 1M. Incluye accesorios para colgar.

Referencia	Artículo	Potencia	Casquillo	Color	Material	Embalaje
000704712	A	Máx. 60W	E27	● Negro	Plástico	20
000705238	B	Máx. 60W	E27	● Oro Viejo	Aluminio	20
000705239	C	Máx. 60W	E27	● Oro Viejo	Aluminio	20



Yaren
LÁMPARA



A

Sedona
LÁMPARA



B

Nowra
LÁMPARA



C

* Bombillas no incluidas.

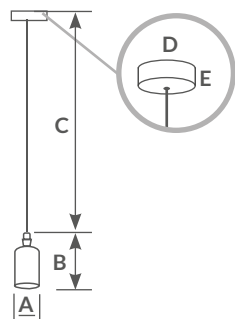

Yaren

- A: Ø48mm
- B: 66mm
- C: 1000mm
- D: Ø100mm
- E: 20mm

Sedona

- A: Ø48mm
- B: 76mm
- C: 1000mm
- D: Ø100mm
- E: 20mm

Nowra

- A: Ø48mm
- B: 76mm
- C: 1000mm
- D: Ø100mm
- E: 20mm



Altura regulable
Altura máx. 1M



Incluye
kit para colgar

Lámparas colgantes



IP20



220-240V



50/60Hz

Cable: 1M. Incluye accesorios para colgar.

Referencia	Artículo	Potencia	Casquillo	Color	Material	Embalaje
000704714	A	Máx. 60W	E27	● Dorado	Latón	50
000704715	B	Máx. 60W	E27	● Dorado	Latón	50
000705237	C	Máx. 60W	E27	● Cobre	Aluminio	50

Cuval
LÁMPARA



A



B



Altura regulable
Altura máx. 1M

Interior Lámparas colgantes

Lámparas colgantes



IP20



250V



50Hz

Cable PVC 1M (2x0.75mm).

Referencia	Artículo	Potencia	Casquillo	Color	Embalaje
101550001	A	Máx. 60W	E27	○ Blanco	20/100
101550002	B	Máx. 60W	E27	● Negro	20/100



A



B



C



Altura regulable
Altura máx. 1M



Incluye
kit para colgar



IP20



220-240V



50/60Hz

Lámparas colgantes

Cable textil: 1M. Material: **silicona**. Incluye accesorios para colgar.

Referencia	Artículo	Potencia	Casquillo	Color	Embalaje
000702180	A	Máx. 60W	E27	● Negro	50
000702181	B	Máx. 60W	E27	● Marrón	50
000702182	C	Máx. 60W	E27	● Gris	50

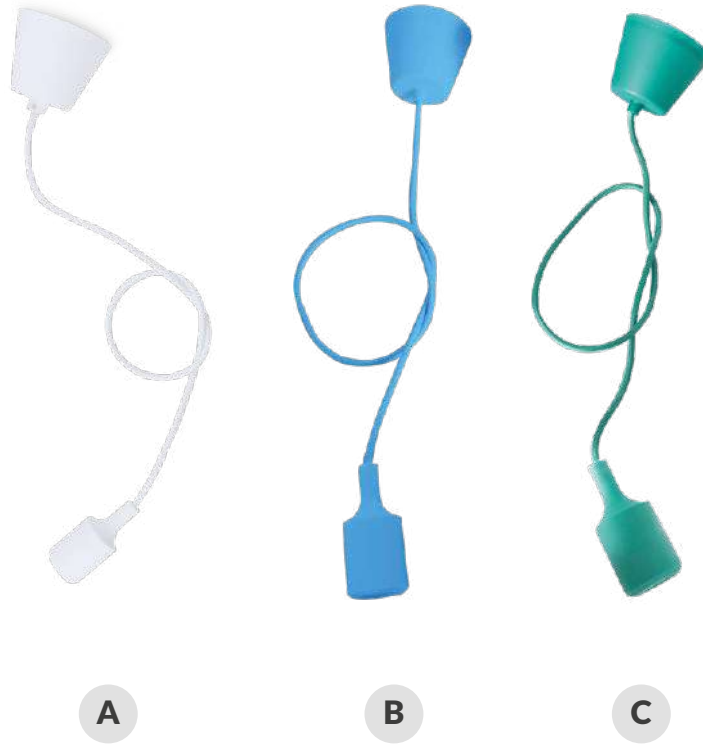

Altura regulable
Altura máx. 1M



Incluye
kit para colgar



IP20



220-240V



50/60Hz

Lámparas colgantes

Cable textil: 1M. Material: **silicona**. Incluye accesorios para colgar.

Referencia	Artículo	Potencia	Casquillo	Color	Embalaje
000703499	A	Máx. 60W	E27	○ Blanco	50
000702183	B	Máx. 60W	E27	● Azul	50
000702184	C	Máx. 60W	E27	● Turquesa	50



A



B



C



D



E



Altura regulable
Altura máx. 1M



Incluye
kit para colgar



IP20



220-240V



50/60Hz

Lámparas colgantes

Cable textil: 1M. Material: **silicona**. Incluye accesorios para colgar.

Referencia	Artículo	Potencia	Casquillo	Color	Embalaje
000702185	A	Máx. 60W	E27	Verde	50
000702188	B	Máx. 60W	E27	Violeta	50
000702186	C	Máx. 60W	E27	Amarillo	50
000702187	D	Máx. 60W	E27	Naranja	50
000702189	E	Máx. 60W	E27	Rojo	50





Langadu

SERIE

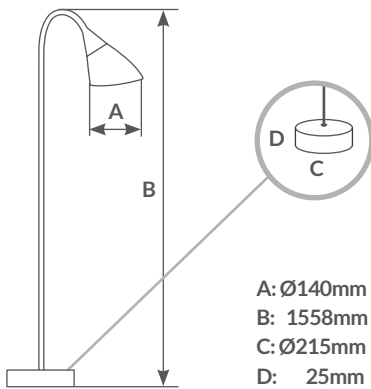
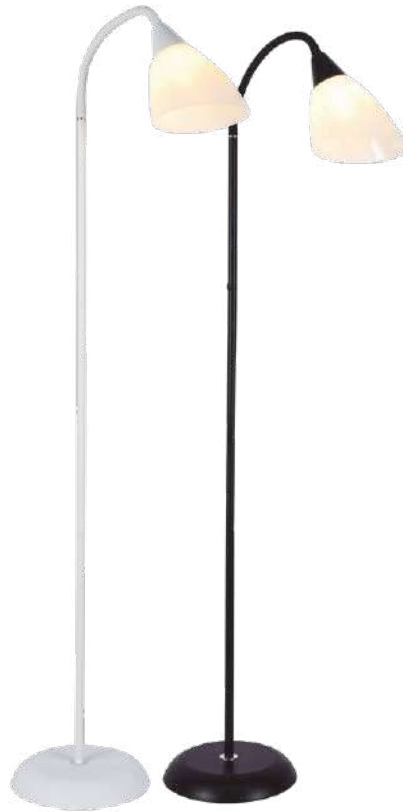

* Bombillas no incluidas.

Interior Lámparas de pie

Lámparas de pie



IP20



220-240V



Hz

50Hz

Cable: 1M. Con interruptor On/Off.

Referencia	Potencia	Casquillo	Color	Material	Embalaje
204400041	Máx. 40W	E27	○ Blanco	Metal + Plástico	1
204400042	Máx. 40W	E27	● Negro	Metal + Plástico	1

Nawis
SERIE

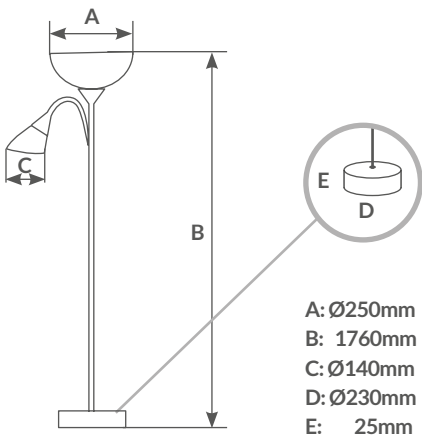

* Bombillas no incluidas.

Interior Lámparas de pie

Lámparas de pie



IP20



220-240V



50Hz

Cable: 1.5M. Con interruptor On/Off. Interruptores independientes.

Referencia	Potencia	Casquillo	Color	Material	Embalaje
204400045	Máx. 40W	E27 + E14	○ Blanco	Metal + Plástico	1
204400043	Máx. 40W	E27 + E14	● Negro	Metal + Plástico	1



Gohira

SERIE

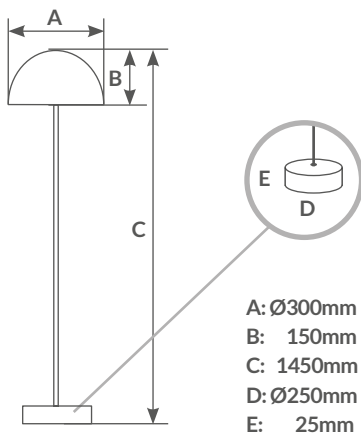

* Bombillas no incluidas.

Interior Lámparas de pie

Lámparas de pie



IP20



220-240V



50Hz

Cable: 1.8M. Con interruptor On/Off.

Referencia	Potencia	Casquillo	Color	Material	Embalaje
204400044	Máx. 40W	E27	● Antracita	Metal	1



A Redondo / Blanco



B Redondo / Níquel



C Semicircular / Blanco



D Semicircular / Níquel

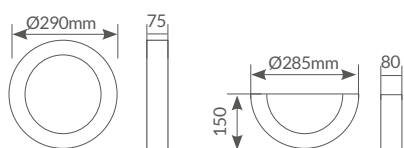

Apliques de pared



IP20



220-240V



50Hz

Uso interior.

Referencia	Artículo	Forma	Potencia	Casquillo	Color	Embalaje
000701936	A	Redonda	Máx. 60W	E27	○ Blanco	8
000701938	B	Redonda	Máx. 60W	E27	● Níquel Satín	8
000701937	C	Semicircular	Máx. 60W	E27	○ Blanco	12
000701939	D	Semicircular	Máx. 60W	E27	● Níquel Satín	12

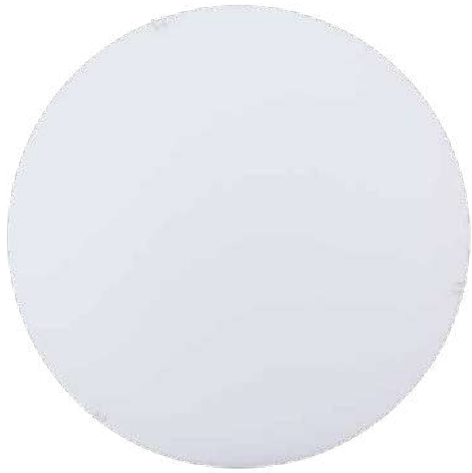

A



B

8LED
COMPATIBLE

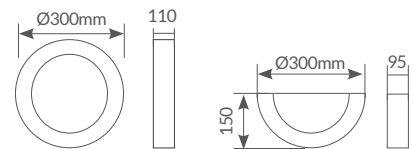

IP20



220-240V



50/60Hz

Apliques de pared

Uso interior.

Referencia	Artículo	Forma	Potencia	Casquillo	Color	Embalaje
000701994	A	Redonda	Máx. 60W	E27	○ Blanco	8
000701995	B	Semicircular	Máx. 60W	E27	○ Blanco	12

Selna
SERIE

8LED
COMPATIBLE



A Simple



B Doble

* Bombilla no incluida.

Interior Focos pared

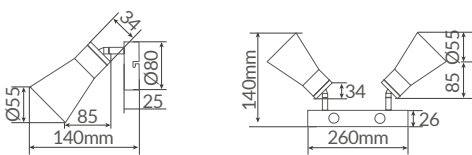

Aplicador de pared con interruptor



IP20



220-240V



50/60Hz

Color: blanco mate. Material: **metal**. Bombilla no incluida. **Brazo articulado**. Uso interior.

Referencia	Artículo	Tipo	Potencia	Casquillo	Embalaje
200000001	A	Simple	Máx. 50W	GU10	20
200000002	B	Doble	Máx. 50W	GU10	20

Kegla
SERIE

8LED
COMPATIBLE



A Simple



B Doble lineal



C Triple circular



D Triple espiral



E Cuádruple lineal

* Bombilla no incluida.

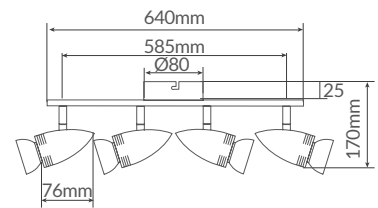
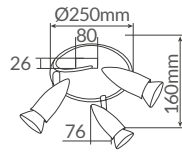
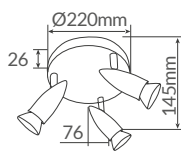
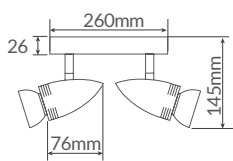
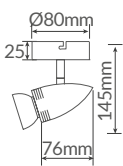

IP20



220-240V



50/60Hz

Focos de techo

Color: níquel satín. Material: metal. Bombilla no incluida. Brazo articulado. Uso interior.

Referencia	Artículo	Tipo	Potencia	Casquillo	Embalaje
202000025	A	Simple	Máx. 50W	GU10	20
202000026	B	Doble lineal	Máx. 50W	GU10	20
202000027	C	Triple circular	Máx. 50W	GU10	12
202000028	D	Triple espiral	Máx. 50W	GU10	12
202000029	E	Cuádruple lineal	Máx. 50W	GU10	8

Kaitola
SERIE

8LED
COMPATIBLE



A Simple



B Doble lineal



C Triple lineal

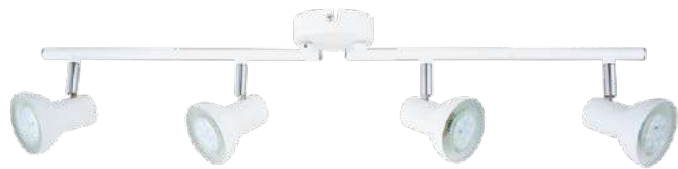

D Cuádruple lineal

* Bombilla no incluida.

Interior Focos techo

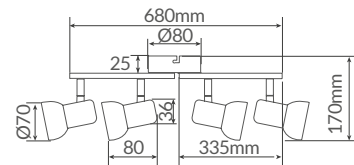
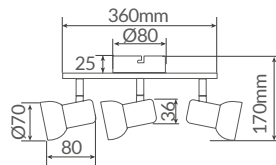
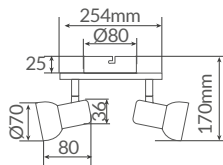
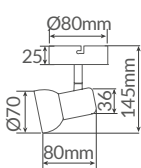

Focos de techo



IP20



220-240V



50/60Hz

Color: blanco mate. Material: **metal**. Bombilla no incluida. **Brazo articulado**. Uso interior.

Referencia	Artículo	Tipo	Potencia	Casquillo	Embalaje
202000033	A	Simple	Máx. 50W	GU10	20
202000034	B	Doble lineal	Máx. 50W	GU10	12
202000035	C	Triple lineal	Máx. 50W	GU10	8
202000036	D	Cuádruple lineal	Máx. 50W	GU10	6

Kaitola
SERIE

8LED
COMPATIBLE



A Simple



B Doble lineal



C Triple lineal



D Cuádruple lineal

* Bombilla no incluida.

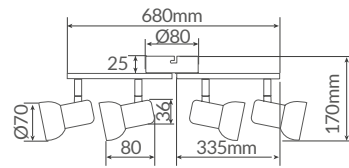
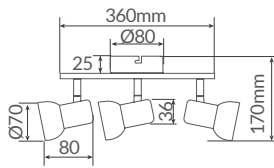
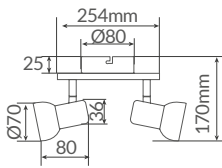
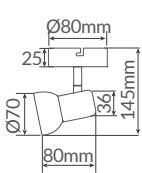

Focos de techo



IP20



220-240V



50/60Hz

Color: negro mate. Material: **metal**. Bombilla no incluida. **Brazo articulado**. Uso interior.

Referencia	Artículo	Tipo	Potencia	Casquillo	Embalaje
202000037	A	Simple	Máx. 50W	GU10	20
202000038	B	Doble lineal	Máx. 50W	GU10	12
202000039	C	Triple lineal	Máx. 50W	GU10	8
202000040	D	Cuádruple lineal	Máx. 50W	GU10	6



A Simple



B Doble lineal



C Triple circular

* Bombilla no incluida.

Interior Focos techo

8LED
COMPATIBLE

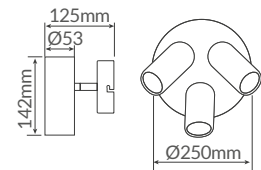
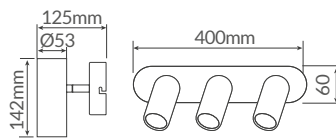
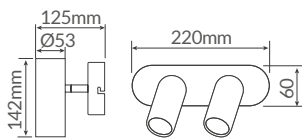
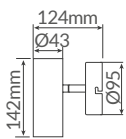

IP20



220-240V



50Hz

Focos de techo

Color: blanco mate. Material: **aluminio**. Bombilla no incluida. **Brazo articulado**. Uso interior.

Referencia	Artículo	Tipo	Potencia	Casquillo	Embalaje
000705200	A	Simple	Máx. 60W	GU10	20
000705201	B	Doble lineal	Máx. 60W	GU10	10
000705202	C	Triple circular	Máx. 60W	GU10	4



Interior Focos techo



8LED
COMPATIBLE

* Bombilla no incluida.

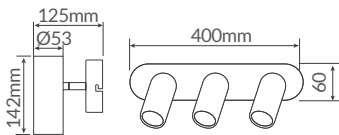

Focos de techo



IP20



220-240V



Hz

50Hz

Color: cobre mate. Material: **aluminio**. Bombilla no incluida. **Brazo articulado**. Uso interior.

Referencia	Tipo	Potencia	Casquillo	Embalaje
202000003	Triple lineal	Máx. 60W	GU10	10



A Simple



B Doble lineal



C Triple lineal



D Cuádruple lineal

* Bombilla no incluida.

Interior Focos techo

LED
COMPATIBLE

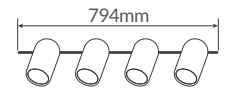
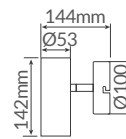
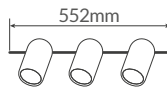
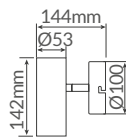
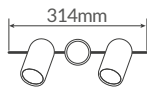
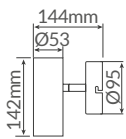
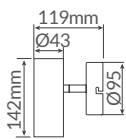

IP20



220-240V



50Hz

Focos de techo

Color: níquel satín. Material: **aluminio**. Bombilla no incluida. **Brazo articulado**. Uso interior.

Referencia	Artículo	Tipo	Potencia	Casquillo	Embalaje
000705203	A	Simple	Máx. 60W	GU10	20
000705204	B	Doble lineal	Máx. 60W	GU10	4
000705205	C	Triple lineal	Máx. 60W	GU10	4
000705206	D	Cuádruple lineal	Máx. 60W	GU10	4

Edina SERIE



A Simple



B Doble lineal



C Triple lineal



D Triple circular

* Bombilla no incluida.

8LED
COMPATIBLE

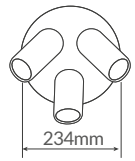
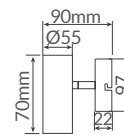
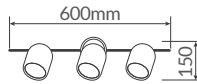
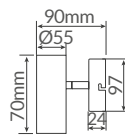
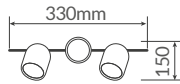
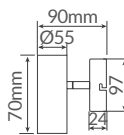
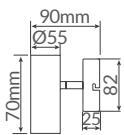

IP20



220-240V



50Hz

Focos de techo

Color: negro. Material: **hierro**. Bombilla no incluida. **Brazo articulado**. Portalámparas incluido. Uso interior.

Referencia	Artículo	Tipo	Potencia	Casquillo	Embalaje
001905356	A	Simple	Máx. 50W	GU10	36
001905358	B	Doble lineal	Máx. 50W	GU10	12
001905360	C	Triple lineal	Máx. 50W	GU10	12
001905362	D	Triple circular	Máx. 50W	GU10	12

Edina

SERIE



A Simple



B Doble lineal



C Triple lineal



D Triple circular

* Bombilla no incluida.

Interior Focos techo

LED

COMPATIBLE

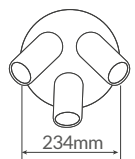
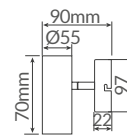
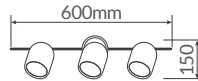
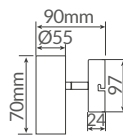
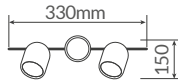
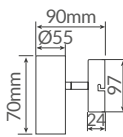
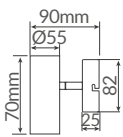

Focos de techo



IP20



220-240V



50Hz

Color: blanco. Material: **metal**. Bombilla no incluida. **Brazo articulado**. Portalámparas incluido. Uso interior.

Referencia	Artículo	Tipo	Potencia	Casquillo	Embalaje
001905355	A	Simple	Máx. 50W	GU10	36
001905357	B	Doble lineal	Máx. 50W	GU10	12
001905359	C	Triple lineal	Máx. 50W	GU10	12
001905361	D	Triple circular	Máx. 50W	GU10	12

Rintela

SERIE



A Simple

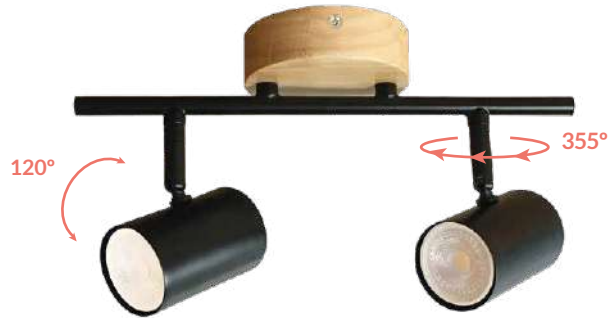

B Doble lineal

LED
COMPATIBLE

* Bombilla no incluida.



Instalación foco simple
en techo y pared

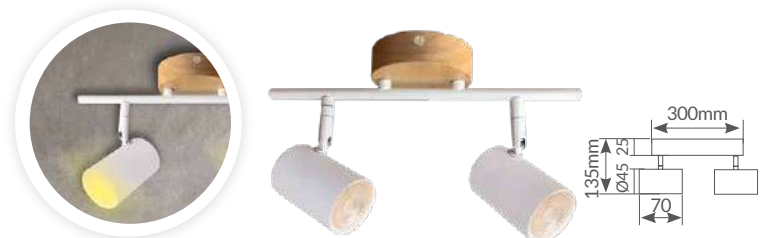

Instalación foco doble
en techo

Focos de techo



IP20



220-240V



50/60Hz

Material: **metal**, **base madera**. Bombilla no incluida. **Brazo articulado**. Portalámparas incluido. Uso interior.

Referencia	Artículo	Tipo	Color	Potencia	Casquillo	Embalaje
202000017	A	Simple	● Negro	Máx. 60W	GU10	50
202000018	A	Simple	○ Blanco	Máx. 60W	GU10	50
202000019	B	Doble lineal	● Negro	Máx. 60W	GU10	20
202000020	B	Doble lineal	○ Blanco	Máx. 60W	GU10	20

Guimara
SERIE

8LED
COMPATIBLE



A Simple



B Doble lineal



C Triple lineal



D Cuádruple lineal

* Bombilla no incluida.

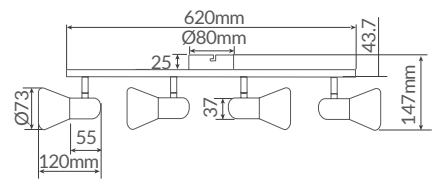
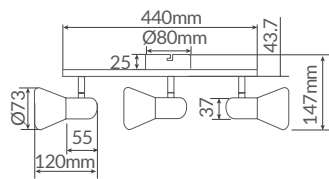
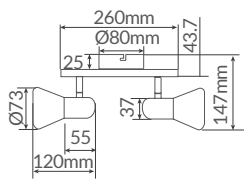
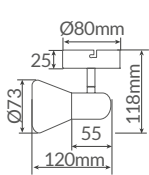

Focos de techo



IP20



220-240V



50/60Hz

Color: níquel satín. Material: **metal + cristal**. Bombilla no incluida. **Brazo articulado**. Uso interior.

Referencia	Artículo	Tipo	Potencia	Casquillo	Embalaje
202000041	A	Simple	Máx. 40W	E14	40
202000042	B	Doble lineal	Máx. 40W	E14	24
202000043	C	Triple lineal	Máx. 40W	E14	8
202000044	D	Cuádruple lineal	Máx. 40W	E14	8

Bhani
SERIE

8LED
COMPATIBLE



A

Simple



B

Doble lineal



C

Triple lineal

* Bombilla no incluida.

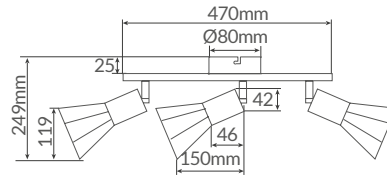
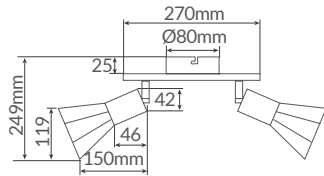
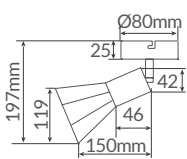

Focos de techo



IP20



220-240V



50/60Hz

Color: negro mate. Material: **metal**. Bombilla no incluida. **Brazo articulado**. Uso interior.

Referencia	Artículo	Tipo	Potencia	Casquillo	Embalaje
202000030	A	Simple	Máx. 40W	E27	20
202000031	B	Doble lineal	Máx. 40W	E27	8
202000032	C	Triple lineal	Máx. 40W	E27	8

Salmela

SERIE



A Simple



B Doble lineal

* Bombilla no incluida.

LED COMPATIBLE



Instalación foco simple en techo y pared



Instalación foco doble en techo

Focos de techo



IP20



220-240V



50/60Hz

Material: **metal**. Bombilla no incluida. **Brazo articulado**. Portalámparas incluido. Uso interior.

Referencia	Artículo	Tipo	Color	Potencia	Casquillo	Embalaje
202000021	A	Simple	● Negro	Máx. 60W	E27	50
202000022	A	Simple	○ Blanco	Máx. 60W	E27	50
202000023	B	Doble lineal	● Negro	Máx. 60W	E27	20
202000024	B	Doble lineal	○ Blanco	Máx. 60W	E27	20

Sehay

SERIE



* Bombilla no incluida.

8LED
COMPATIBLE

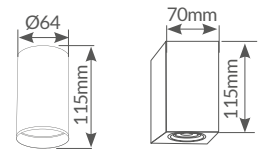

Foco redondo de techo



Instalación en techo. Color: blanco mate. Material: **aluminio.**
Para lámparas dicroicas. Bombilla no incluida. **Portalámparas GU10 incluido.**

Referencia	Artículo	Tipo	Potencia	Embalaje
20200004	A	Redondo	Máx. 10W	10/60
20200005	B	Cuadrado	Máx. 10W	10/60

Serkka

SERIE



Instalación en pared

Instalación en techo

8LED
COMPATIBLE

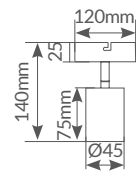
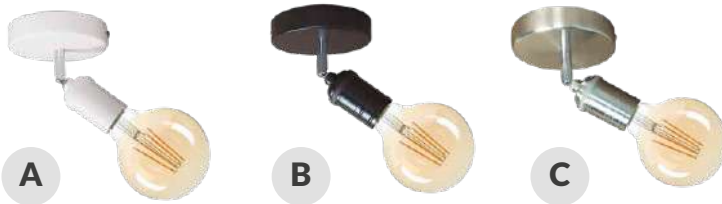

* Bombilla no incluida.

Focos de techo



IP20



220-240V



50/60Hz

Cabezal de metal. Bombilla no incluida. Brazo articulado. Portalámparas incluido. Uso interior.

Referencia	Artículo	Tipo	Color	Potencia	Casquillo	Embalaje
202000006	A	Simple	○ Blanco	Máx. 60W	E27	50
202000007	B	Simple	● Negro	Máx. 60W	E27	50
202000008	C	Simple	● Níquel Satín	Máx. 60W	E27	50

Kestila

SERIE



Instalación en pared

Instalación en techo

8LED
COMPATIBLE

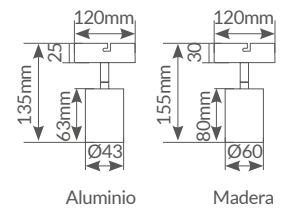
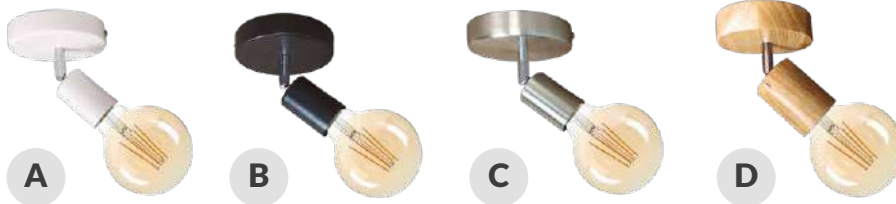

* Bombilla no incluida.



IP20



220-240V



50/60Hz

Focos de techo

Material: **metal** (202000009-10-11), **madera** (202000012).
Bombilla no incluida. **Brazo articulado**. Portalámparas incluido. Uso interior.

Referencia	Artículo	Tipo	Color	Potencia	Casquillo	Embalaje
202000009	A	Simple	○ Blanco	Máx. 60W	E27	50
202000010	B	Simple	● Negro	Máx. 60W	E27	50
202000011	C	Simple	● Níquel Satín	Máx. 60W	E27	50
202000012	D	Simple	● Madera	Máx. 60W	E27	50

Jokela
SERIE



Interior Focos techo

LED
COMPATIBLE

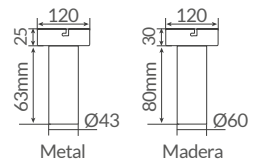

* Bombilla no incluida.



IP20



220-240V



50/60Hz

Focos de techo

Material: **metal** (202000013-14-15), **madera** (202000016). Bombilla no incluida.
Brazo articulado. Portalámparas incluido. Uso interior.

Referencia	Artículo	Tipo	Color	Potencia	Casquillo	Embalaje
202000013	A	Simple	○ Blanco	Máx. 60W	E27	50
202000014	B	Simple	● Negro	Máx. 60W	E27	50
202000015	C	Simple	● Níquel Satín	Máx. 60W	E27	50
202000016	D	Simple	● Madera	Máx. 60W	E27	50



8LED
COMPATIBLE

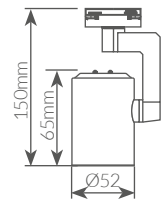

IP20



220-240V



50Hz

Foco carril monofásico

Tipo: **orientable**. Material: **plástico + metal**. Ideal para dicroicas. Bombilla no incluida. Uso interior.

Referencia	Potencia	Casquillo	Color	Embalaje
202205001	Máx. 20W	GU10	● Negro	50
202205002	Máx. 20W	GU10	○ Blanco	50



Interior Comercial

8LED
COMPATIBLE

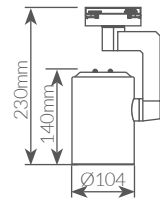

IP20



220-240V



50Hz

Foco carril **monofásico**

Tipo: **orientable**. Material: **plástico + metal**. Ideal para reflectoras R90. Bombilla no incluida. Uso interior.

Referencia	Potencia	Casquillo	Color	Embalaje
202205003	Máx. 30W	E27	● Negro	20
202205004	Máx. 30W	E27	○ Blanco	20



A



B



C



D



E

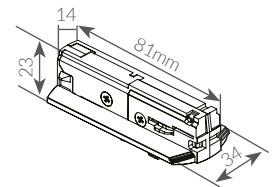
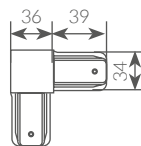
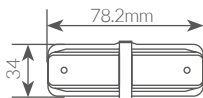
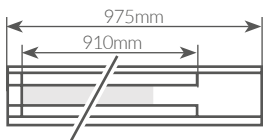

IP20



220-240V



50/60Hz

Accesorios para focos monofásicos

Para foco monofásico. Uso interior.

Referencia	Artículo	Descripción	Color	Material	Embalaje
202200001	A	Carril	● Negro	Aluminio	50
202200002	A	Carril	○ Blanco	Aluminio	50
202210001	B	Conector recto	● Negro	ABS + Hierro	100
202210002	B	Conector recto	○ Blanco	ABS + Hierro	100
202210005 ★	C	Conector L	● Negro	ABS + Hierro	10
202210006 ★	C	Conector L	○ Blanco	ABS + Hierro	10
202210003	D	Kit suspensión	● Negro	Hierro	100
202210004	D	Kit suspensión	○ Blanco	Hierro	100
202205005	E	Luminaria prensa estopa	● Negro	ABS + Hierro	250
202205006	E	Luminaria prensa estopa	○ Blanco	ABS + Hierro	250



Ubari
EMPOTRABLE



40W

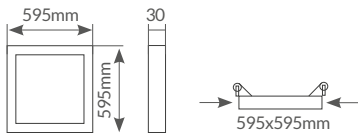
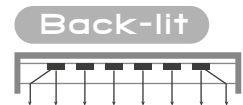

- 4200K
- 6000K
- 120°
- 100.000
- ≥80Ra
- 30.000h.
- 200-240V
- 50/60Hz

Interior Paneles LED

Panel empotrable LED

Forma: **cuadrada**. Tipo: **empotrable**. LED driver incluido. Material: **aluminio + PS**. Uso interior. IP20. **IK05**.

Referencia	Con difusor / Luminaria (360°)	Sin difusor / Fuente de luz (360°)	Luz	Color	Embalaje
203400012	40W / 4200Lm	36W / 4650Lm	4200K	○ Blanco	6
203400013	40W / 4200Lm	36W / 4650Lm	6000K	○ Blanco	6
203400031 ★	40W / 4200Lm	36W / 4400Lm	4200K	● Negro	6
203400032 ★	40W / 4200Lm	36W / 4400Lm	6000K	● Negro	6
203415002	Recambio driver 40W				

Sabha

EMPOTRABLE

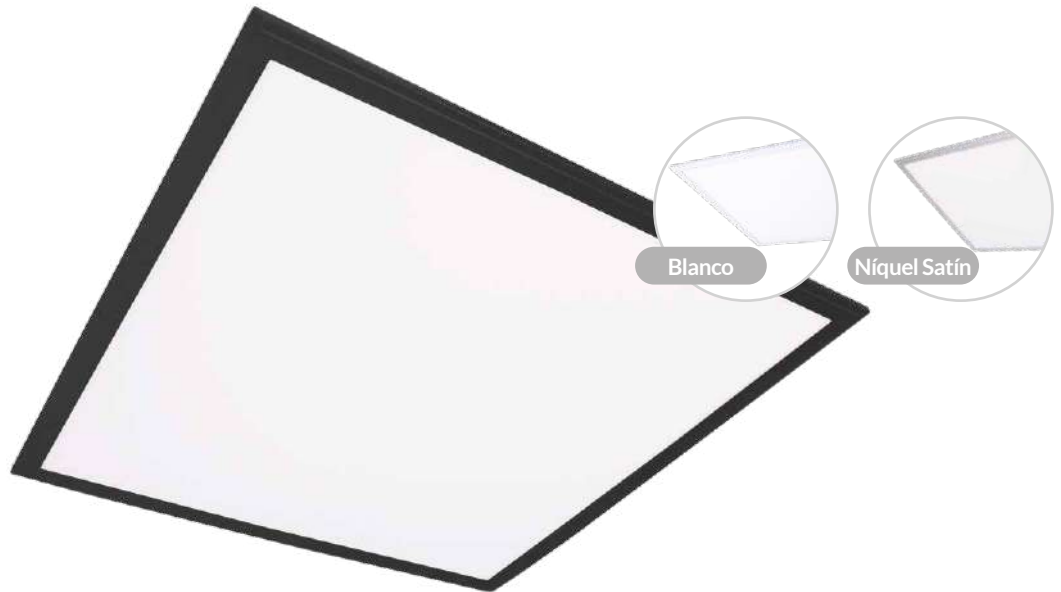

40W

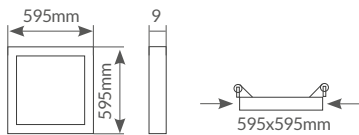
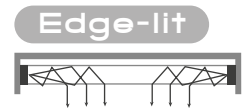

- 4200K
- 6000K
- 120°
- 100.000
- ≥80Ra
- 30.000h.
- 200-240V
- 50/60Hz

Panel empotrable ultrafino LED

Forma: **cuadrada**. LED driver incluido. Material: **aluminio + PS**. Uso interior.
 Posibilidades de instalación: **en techo sin separadores, para colgar y tipo downlight**.

Referencia	Con difusor / Luminaria (360°)	Sin difusor / Fuente de luz (360°)	Luz	Color	Embalaje
203400008	40W / 4000Lm	36W / 4650Lm	4200K	Blanco	6
203400009	40W / 4000Lm	36W / 4650Lm	6000K	Blanco	6
203400010	40W / 4000Lm	36W / 4650Lm	4200K	Níquel Satín	6
203400011	40W / 4000Lm	36W / 4650Lm	6000K	Níquel Satín	6
203400029	40W / 4000Lm	36W / 4650Lm	4200K	Negro	6
203400030	40W / 4000Lm	36W / 4650Lm	6000K	Negro	6
203415002	Recambio driver 40W				

Lubuko
EMPOTRABLE



UGR<19

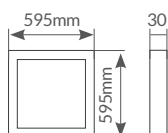

4200K



5000K



120°



100.000



≥80Ra



50.000h.



IP44



220-240V



50/60Hz

Panel empotrable LED

Forma: **cuadrada**. Tipo: **empotrable**. LED driver incluido. Material: **aluminio + PS**.
Sustituye a los paneles tradicionales. **IK05. PF 0.95. Se vende en pack de 2 unidades.**

Referencia	Con difusor / Luminaria (360°)	Sin difusor / Fuente de luz (360°)	Luz	Color	Embalaje
203400024	40W / 4800Lm	36W / 5200Lm	● 4200K	○ Blanco	4
203400025	40W / 4800Lm	36W / 5200Lm	● 5000K	○ Blanco	4
203415007	Recambio driver 40W				

Interior Paneles LED

Gilé

EMPOTRABLE

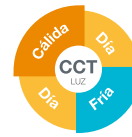

40W



UGR<19

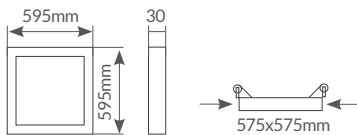
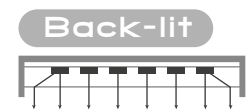

-  120°
-  100.000
-  ≥80Ra
-  30.000h.
-  220-240V
-  50/60Hz

Panel empotrable LED

Forma: **cuadrada**. Tipo: **empotrable**. LED driver incluido. Material: **aluminio + PS**. Uso interior. IP20. **IK05. PF 0.95**. Cambio de temperatura a través del interruptor.

Referencia	Con difusor / Luminaria (360°)	Sin difusor / Fuente de luz (360°)	Luz	Color	Embalaje
203400026	40W / 3600Lm	36W / 4400Lm	3000-4000-6000K	○ Blanco	6
203415002	Recambio driver 40W				

Reteta
EMPOTRABLE



40W

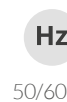
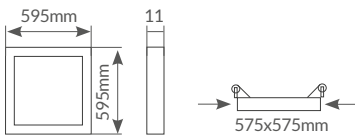

4200K

6000K

120°

100.000

≥80Ra

30.000h.

220-240V

50/60Hz

Marco empotrable panel LED

Forma: **cuadrada**. Tipo: **empotrable**. LED driver incluido. Material: **aluminio + PC**.
Sustituye a los paneles tradicionales. Uso interior. IP20. **IK05. PF 0.95**.

Referencia	Con difusor / Luminaria (360°)	Sin difusor / Fuente de luz (360°)	Luz	Color	Embalaje
203400027	40W / 4000Lm	36W / 4400Lm	● 4200K	○ Blanco	10
203400028	40W / 4000Lm	36W / 4400Lm	● 6000K	○ Blanco	10
203415002	Recambio driver 40W				

Hassi

EMPOTRABLE



Interior Paneles LED

40W 60W

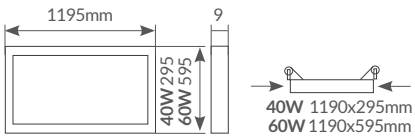

- 4200K
- 6000K
- 120°
- 100.000
- ≥80Ra
- 30.000h.
- 220-240V
- 50/60Hz

Panel empotrable rectangular LED

Forma: **rectangular**. LED driver incluido. Material: **aluminio + PS**. Uso interior.
 Posibilidades de instalación: **en techo sin separadores, para colgar y tipo downlight.**

Referencia	Con difusor / Luminaria (360°)	Sin difusor / Fuente de luz (360°)	Luz	Color	Embalaje
203400014	40W / 4000Lm	36W / 4550Lm	4200K	Níquel Satin	5
203400015	40W / 4000Lm	36W / 4550Lm	6000K	Níquel Satin	5
203415002	Recambio driver 40W				
203415001	Recambio driver 30W para paneles de 60W se utilizan 2 recambios (30W x 2)				

Luena
EMPOTRABLE

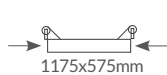
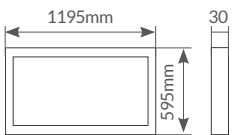

Panel empotrable LED

Forma: **rectangular**. Tipo: **empotrable**. LED driver incluido. Material: **aluminio + PS**. Uso interior. IP20. **IK05. PF 0.95**.

Referencia	Con difusor / Luminaria (360°)	Sin difusor / Fuente de luz (360°)	Luz	Color	Embalaje
203400033 ★	40W / 4000Lm	36W / 4400Lm	● 4200K	○ Blanco	6
203400034 ★	40W / 4000Lm	36W / 4400Lm	● 6000K	○ Blanco	6
203400035 ★	40W / 4000Lm	36W / 4400Lm	● 4200K	● Níquel Satín	6
203400036 ★	40W / 4000Lm	36W / 4400Lm	● 6000K	● Níquel Satín	6
203400022	60W / 6000Lm	54W / 6600Lm	● 4200K	○ Blanco	6
203400023	60W / 6000Lm	54W / 6600Lm	● 6000K	○ Blanco	6
203400037 ★	60W / 6000Lm	54W / 6600Lm	● 4200K	● Níquel Satín	6
203400038 ★	60W / 6000Lm	54W / 6600Lm	● 6000K	● Níquel Satín	6
203415001	Recambio driver 30W para paneles de 60W (30W x 2)				

Borma
SUPERFICIE

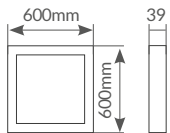
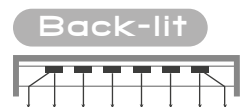

4200K



6000K



120°



100.000



≥80Ra



30.000h.



IP20



220-240V



50/60Hz

Panel superficie LED

Forma: **cuadrada**. Tipo: **superficie**. LED driver incluido. Material: **aluminio + PS**.
Sustituye a los paneles tradicionales. Uso interior. **IK05. PF 0.95**.

Referencia	Con difusor / Luminaria (360°)	Sin difusor / Fuente de luz (360°)	Luz	Color	Embalaje
203405015	40W / 4200Lm	36W / 4650Lm	● 4200K	○ Blanco	6
203405016	40W / 4200Lm	36W / 4650Lm	● 6000K	○ Blanco	6
203405043 ★	40W / 4200Lm	36W / 4650Lm	● 4200K	● Níquel Satín	6
203405044 ★	40W / 4200Lm	36W / 4650Lm	● 6000K	● Níquel Satín	6
203405025 ★	40W / 4200Lm	36W / 4650Lm	● 4200K	● Negro	6
203405026 ★	40W / 4200Lm	36W / 4650Lm	● 6000K	● Negro	6
203405002	Recambio driver 40W				

Menia
SUPERFICIE

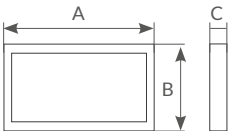

Interior Paneles LED

Panel rectangular superficie LED

Forma: **rectangular**. Tipo: **superficie**. LED driver incluido. Material: **aluminio**. Sustituye a los paneles tradicionales. Uso interior. **IK05**.

Referencia	Con difusor / Luminaria (360°)	Sin difusor / Fuente de luz (360°)	Luz	Color	Dimensión (AxBxC)	Embalaje
203405004	24W / 2160Lm	21.6W / 2630Lm	● 4200K	● Níquel Satín	600x300x38mm	5
203405006	24W / 2160Lm	21.6W / 2630Lm	● 6000K	● Níquel Satín	600x300x38mm	5
000704064	Recambio driver 24W					
203405008	36W / 3420Lm	32.4W / 3950Lm	● 4200K	● Níquel Satín	900x300x38mm	5
203405010	36W / 3420Lm	32.4W / 3950Lm	● 6000K	● Níquel Satín	900x300x38mm	5
000704066	Recambio driver 36W					
203405012	40W / 4000Lm	36W / 4450Lm	● 4200K	● Níquel Satín	1200x300x38mm	5
203405014	40W / 4000Lm	36W / 4450Lm	● 6000K	● Níquel Satín	1200x300x38mm	5
203415002	Recambio driver 40W					

Kisongo
SUPERFICIE

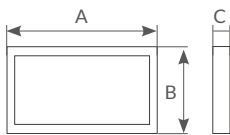
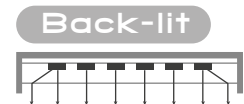

Interior Paneles LED

Panel rectangular superficie LED

Forma: **rectangular**. Tipo: **superficie**. LED driver incluido. Material: **aluminio + PS**.
Sustituye a los paneles tradicionales. Uso interior. **IK05. PF 0.95**.

Referencia	Con difusor / Luminaria (360°)	Sin difusor / Fuente de luz (360°)	Luz	Color	Dimensión (AxBxC)	Embalaje
203405017	24W / 2400Lm	21.6W / 2600Lm	● 4200K	○ Blanco	600x300x38mm	6
203405018	24W / 2400Lm	21.6W / 2600Lm	● 6000K	○ Blanco	600x300x38mm	6
203415004	Recambio driver 24W					
203405019	36W / 3600Lm	32.4W / 3900Lm	● 4200K	○ Blanco	900x300x38mm	6
203405020	36W / 3600Lm	32.4W / 3900Lm	● 6000K	○ Blanco	900x300x38mm	6
203415006	Recambio driver 36W					
203405021	40W / 4000Lm	36W / 4400Lm	● 4200K	○ Blanco	1200x300x38mm	6
203405022	40W / 4000Lm	36W / 4400Lm	● 6000K	○ Blanco	1200x300x38mm	6
203405002	Recambio driver 40W					
203405023	60W / 6000Lm	54W / 6600Lm	● 4200K	○ Blanco	1200x600x38mm	6
203405024	60W / 6000Lm	54W / 6600Lm	● 6000K	○ Blanco	1200x600x38mm	6
203415005	Recambio driver 30W para paneles de 60W (30W x 2)					

Kisongo

SUPERFICIE

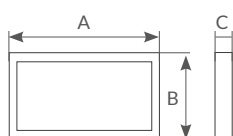

4200K



6000K



120°



100.000



≥80Ra



30.000h.



220-240V



50/60Hz

Panel rectangular superficie LED

Forma: **rectangular**. Tipo: **superficie**. LED driver incluido. Material: **aluminio + PS**.
Sustituye a los paneles tradicionales. Uso interior. **IK05. PF 0.95**.

Referencia	Con difusor / Luminaria (360°)	Sin difusor / Fuente de luz (360°)	Luz	Color	Dimensión (AxBxC)	Embalaje
203405035	24W / 2400Lm	21.6W / 2600Lm	● 4200K	● Níquel Satín	600x300x38mm	6
203405036	24W / 2400Lm	21.6W / 2600Lm	● 6000K	● Níquel Satín	600x300x38mm	6
203415004	Recambio driver 24W					
203405037	36W / 3600Lm	32.4W / 3900Lm	● 4200K	● Níquel Satín	900x300x38mm	6
203405038	36W / 3600Lm	32.4W / 3900Lm	● 6000K	● Níquel Satín	900x300x38mm	6
203415006	Recambio driver 36W					

Kisongo
SUPERFICIE

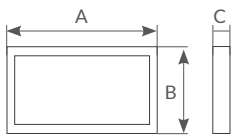
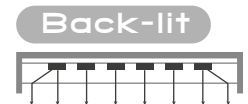

Interior Focos pared

Panel rectangular superficie LED

Forma: **rectangular**. Tipo: **superficie**. LED driver incluido. Material: **aluminio + PS**.
Sustituye a los paneles tradicionales. Uso interior. **IK05. PF 0.95**.

Referencia	Con difusor / Luminaria (360°)	Sin difusor / Fuente de luz (360°)	Luz	Color	Dimensión (AxBxC)	Embalaje
203405027	24W / 2400Lm	21.6W / 2600Lm	● 4200K	● Negro	600x300x38mm	6
203405028	24W / 2400Lm	21.6W / 2600Lm	● 6000K	● Negro	600x300x38mm	6
203415004	Recambio driver 24W					
203405029	36W / 3600Lm	32.4W / 3900Lm	● 4200K	● Negro	900x300x38mm	6
203405030	36W / 3600Lm	32.4W / 3900Lm	● 6000K	● Negro	900x300x38mm	6
203415006	Recambio driver 36W					
203405031	40W / 4000Lm	36W / 4400Lm	● 4200K	● Negro	1200x300x38mm	6
203405032	40W / 4000Lm	36W / 4400Lm	● 6000K	● Negro	1200x300x38mm	6
203405002	Recambio driver 40W					
203405033	60W / 6000Lm	54W / 6600Lm	● 4200K	● Negro	1200x600x38mm	6
203405034	60W / 6000Lm	54W / 6600Lm	● 6000K	● Negro	1200x600x38mm	6
203415005	Recambio driver 30W para paneles de 60W (30W x 2)					

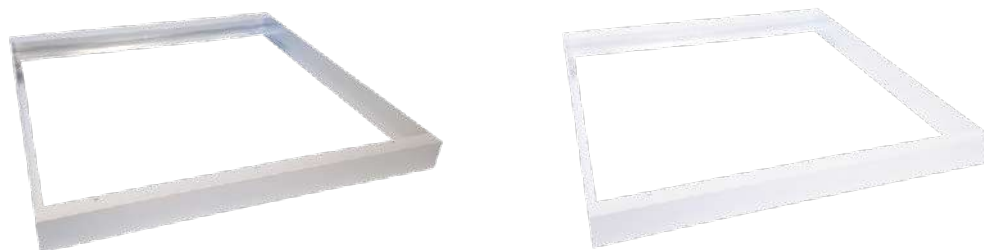

Set para superficie paneles LED

Para colgar paneles LED: Sabha. Uso interior.

Referencia	Dimensión	Color	Material	Embalaje
000704019	600x600x43mm	● Níquel Satín	Aluminio	1
000704020	600x600x43mm	○ Blanco	Aluminio	1

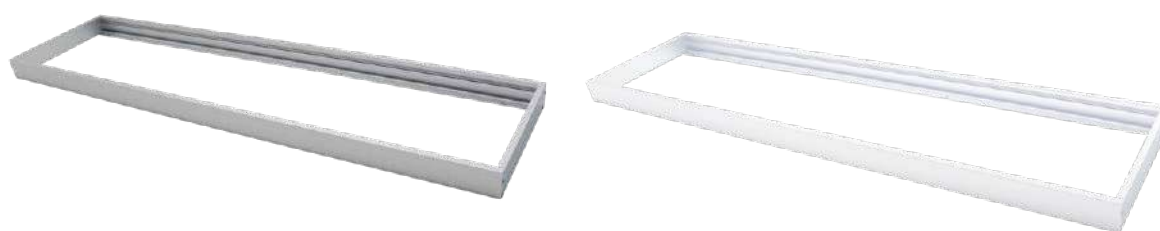

Set para superficie paneles LED

Para colgar paneles LED: Hassi. Uso interior.

Referencia	Dimensión	Color	Material	Embalaje
000704033	300x1200x43mm	● Níquel Satín	Aluminio	1
000703455	600x1200x43mm	○ Blanco	Aluminio	1



Set para colgar paneles LED

Para colgar paneles LED: Sabha y Hassi. Uso interior.

Referencia	Longitud	Embalaje
000702179	Máx. 1M	100



Montaje tipo downlight paneles LED

Para montar paneles LED tipo downlight: Sabha y Hassi. Uso interior.

Referencia	Unidades	Embalaje
000704014	Pack 4	1



Driver LIFUD regulable TRIAC para paneles LED

Para paneles LED: Sabha, Hassi, Luena, Gilé, Ubari, Reteta y Lubuko. Uso interior.

Referencia	Potencia	Voltaje salida	Voltaje entrada	Embalaje
203410001	40W	33-40V	220-240V	1



Set para emergencias paneles LED

Para colgar paneles LED: Hassi. Uso interior. IP20.

Referencia	Potencia	Función	Voltaje	Embalaje
000704042	42W	Emergencia	220-240V	25



Lokutu
REGLETA

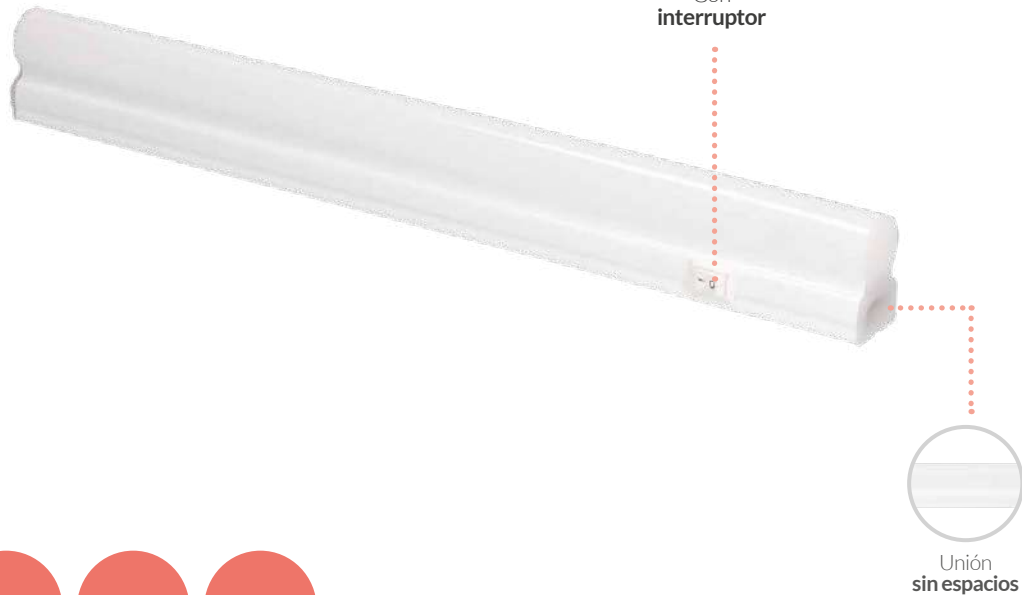

- 4W
- 8W
- 12W
- 16W

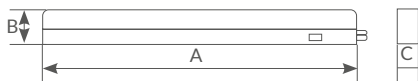

- 6500K
- 160°
- 10.000
- ≥80Ra
- 30.000h.
- 220V
- Hz

Regleta T5 LED

Con interruptor. **Interconexionables.** Cable 1.5M.
Possibilidad de unir hasta 10 regletas (203800050-51-52) y 8 regletas (203800053). Uso interior.

Referencia	Potencia	Lúmenes	Luz	Dimensión (AxBxC)	Embalaje
203800050	4W	400Lm	● 6500K	305x23x32mm	25
203800051	8W	790Lm	● 6500K	575x23x32mm	25
203800052	12W	1160Lm	● 6500K	875x23x32mm	25
203800053	16W	1600Lm	● 6500K	1179x23x32mm	25

Belo

REGLETA

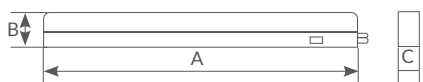
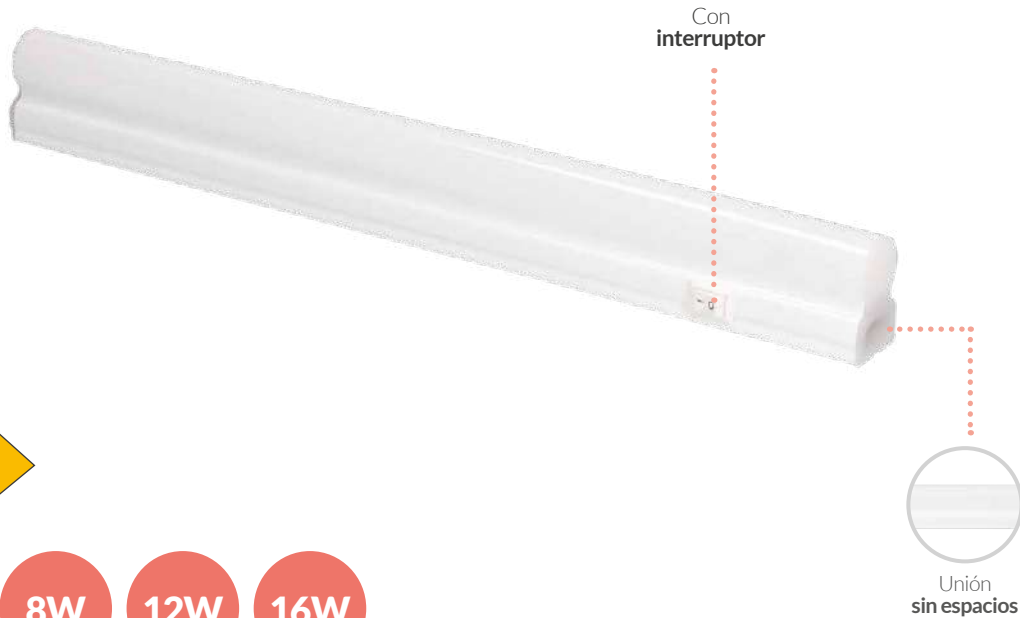

4000K



6500K



120°



10.000



≥80Ra



25.000h.



230V



50Hz

Regleta T5 LED

Con interruptor. **Interconexionables.** Cable 1.5M.
Posibilidad de unir hasta 10 regletas. Uso interior.

Referencia	Potencia	Lúmenes	Luz	Dimensión (AxBxC)	Embalaje
203800033	4W	450Lm	● 4000K	310x23x36mm	20
203800034	4W	450Lm	● 6500K	310x23x36mm	20
203800035	8W	950Lm	● 4000K	570x23x36mm	20
203800036	8W	950Lm	● 6500K	570x23x36mm	20
203800037	12W	1380Lm	● 4000K	870x23x36mm	20
203800038	12W	1380Lm	● 6500K	870x23x36mm	20
203800039	16W	1830Lm	● 4000K	1170x23x36mm	20
203800040	16W	1830Lm	● 6500K	1170x23x36mm	20

Kolari

REGLETA

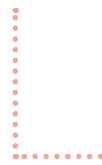

Fácil
instalación



9W

18W

24W

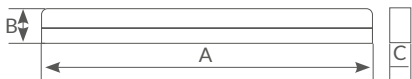

4200K



6500K



120°



≥20.000



≥80Ra



25.000h.



220-240V



50Hz

Regleta electrónica T8 LED

Uso interior.

Referencia	Con difusor / Luminaria (360°)	Sin difusor / Fuente de luz (360°)	Luz	Dimensión (AxBxC)	Embalaje
203800027	9W / 850Lm	9W / 950Lm	● 4200K	600x39.2x27.7mm	20
203800028	9W / 850Lm	9W / 950Lm	● 6500K	600x39.2x27.7mm	20
203800029	18W / 1700Lm	18W / 1900Lm	● 4200K	1200x39.2x27.7mm	20
203800030	18W / 1700Lm	18W / 1900Lm	● 6500K	1200x39.2x27.7mm	20
203800031	24W / 2300Lm	24W / 2600Lm	● 4200K	1500x39.2x27.7mm	20
203800032	24W / 2300Lm	24W / 2600Lm	● 6500K	1500x39.2x27.7mm	20

Nalheri

REGLETA

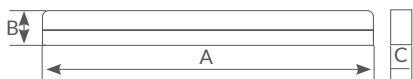
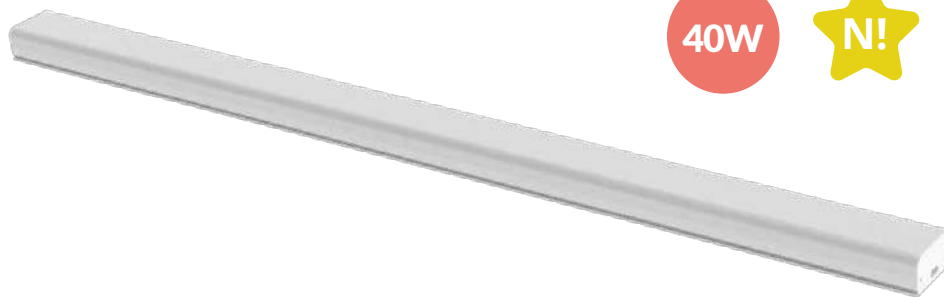

5700K



120°



≥20.000



≥80Ra



30.000h.



220-240V



50/60Hz

Regleta LED

Con interruptor. **Interconexionables.** Cable 100mm.
Possibilidad de unir hasta 10 regletas. Uso interior. IK08. PF ≥0.9.

Referencia	Potencia	Lúmenes	Luz	Dimensión (AxBxC)	Embalaje
203800072	40W	4400Lm	● 5700K	1200x40x70mm	20



Bame
REGLETA



18W

36W



18W



36W

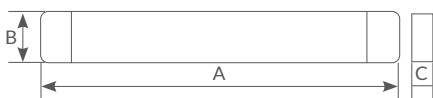

4000K



6000K



110°



>15.000



≥80Ra



25.000h.



170-250V



50/60Hz

Regleta LED

Matetia: **plástico**. Cable 150mm. Uso interior. IP20. IK08.

Referencia	Con difusor / Luminaria (360°)	Sin difusor / Fuente de luz (360°)	Luz	Dimensión (AxBxC)	Embalaje
203800068	18W/ 1700Lm	18W/ 1950Lm	● 4000K	600x75x25mm	20
203800069	18W/ 1700Lm	18W/ 1950Lm	● 6000K	600x75x25mm	20
203800070	36W/ 3700Lm	36W/ 4000Lm	● 4000K	1200x75x25mm	20
203800071	36W/ 3700Lm	36W/ 4000Lm	● 6000K	1200x75x25mm	20

Kenge

REGLETA



25W

35W

48W



Fácil instalación

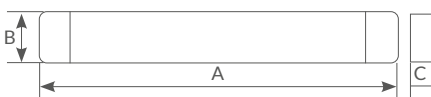

4200K



6500K



110°



≥15.000



≥80Ra



25.000h.



220-240V



50Hz

Regleta techo LED

Fijación en techo. Sin cable, fácil conexionado. Material: **PMMA + aluminio.** Uso interior.

Referencia	Con difusor / Luminaria (360°)	Sin difusor / Fuente de luz (360°)	Luz	Dimensión (AxBxC)	Embalaje
203800054	25W / 2400Lm	25W / 2700Lm	● 4200K	613x120x31mm	12
203800055	25W / 2400Lm	25W / 2700Lm	● 6500K	613x120x31mm	12
203800056	35W / 3200Lm	35W / 3800Lm	● 4200K	913x120x31mm	6
203800057	35W / 3200Lm	35W / 3800Lm	● 6500K	913x120x31mm	6
203800058	48W / 4700Lm	48W / 5200Lm	● 4200K	1213x120x31mm	6
203800059	48W / 4700Lm	48W / 5200Lm	● 6500K	1213x120x31mm	6



Tilani
APLIQUE



4.5W



Caja conexión externa **IP44**.

*Se vende por separado



Para instalación en **pared**.



Para instalación en **armarios**.



Para colocar en espejos de **hasta 8mm**.

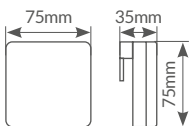

4000K



6500K



110°



>15.000



≥80Ra



25.000h.



IP44



220-240V



50/60Hz

Aplique baño LED

Montaje en **pared y sobre el borde del espejo**. Ideal para baños u otras estancias. Accesorios de instalación incluidos. Material: **PC**. Cable: 300mm.

Referencia	Con difusor / Luminaria (360°)	Sin difusor / Fuente de luz (360°)	Luz	Embalaje
203800062	4.5W / 385Lm	4.5W / 500Lm	● 4000K	100
203800063	4.5W / 385Lm	4.5W / 500Lm	● 6500K	100
203805001	Bolsa 5 unidades conectores IP44 para apliques de baño			



Inada
APLIQUE



4.5W



Caja conexión externa **IP44**.

*Se vende por separado



Para instalación en **pared**.



Para instalación en **armarios**.



Para colocar en espejos de **hasta 8mm**.

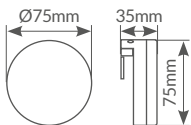

4000K



6500K



110°



>15.000



≥80Ra



25.000h.



IP44



220-240V



50/60Hz

Aplique baño LED

Montaje en **pared y sobre el borde del espejo**. Ideal para baños u otras estancias. Accesorios de intaslación incluidos. Material: **PC**. Cable: 300mm.

Referencia	Con difusor / Luminaria (360°)	Sin difusor / Fuente de luz (360°)	Luz	Embalaje
203800064	4.5W / 385Lm	4.5W / 500Lm	● 4000K	100
203800065	4.5W / 385Lm	4.5W / 500Lm	● 6500K	100
203805001	Bolsa 5 unidades conectores IP44 para apliques de baño			



Nakur
APLIQUE



Caja conexión externa **IP44**.

*Se vende por separado



Para instalación en **pared**.



Para colocar en espejos de **hasta 7mm**.

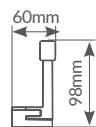
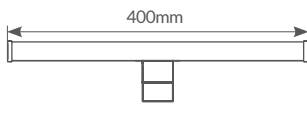

4000K



6500K



110°



>15.000



≥80Ra



25.000h.



IP44



220-240V



50/60Hz

Aplique baño LED

Montaje en **pared y sobre el borde del espejo**. Ideal para baños u otras estancias.
Accesorios de intaslación incluidos. Material: **PC**. Cable: 300mm.

Referencia	Con difusor / Luminaria (360°)	Sin difusor / Fuente de luz (360°)	Luz	Embalaje
203800066	6W / 570Lm	6W / 800Lm	● 4000K	20
203800067	6W / 570Lm	6W / 800Lm	● 6500K	20
203805001	Bolsa 5 unidades conectores IP44 para apliques de baño			

Amnes

APLIQUE



5W



Caja conexión externa **IP44**.



Para instalación en **armarios**.



Para colocar en espejos de **hasta 7mm**.

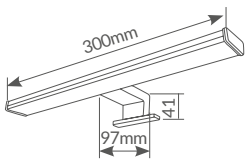

6500K



100°



>15.000



≥80Ra



20.000h.



IP44



230V



50/60Hz

Aplique baño LED

Montaje en **armarios y espejos**. Material: **PC**.
Cable: 300mm. Ideal para baños u otras estancias. **IK04**.

Referencia	Con difusor / Luminaria (360°)	Sin difusor / Fuente de luz (360°)	Luz	Embalaje
203800046	5W / 350Lm	5W / 550Lm	● 6500K	20

Sund
APLIQUE



8W



Caja conexión externa IP44.



Para instalación en pared.

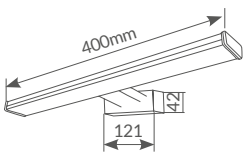

6500K



110°



>15.000



≥80Ra



20.000h.



IP44



220-240V



50/60Hz

Aplique baño LED

Montaje en **pared**. Ideal para baños u otras estancias. Material: **aluminio + PC**. Cable: 100mm. **IK04**.

Referencia	Con difusor / Luminaria (360°)	Sin difusor / Fuente de luz (360°)	Luz	Embalaje
203800045	8W/640Lm	8W/900Lm	● 6500K	20

Laksa

APLIQUE



Caja conexión externa **IP44**.

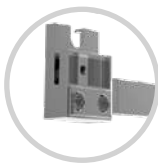

Para instalación en **pared**.



Para instalación en **armarios**.



Para colocar en espejos de **hasta 7mm**.

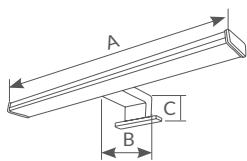

4000K



6500K



110°



>15.000



≥80Ra



25.000h.



220-240V



50/60Hz

Aplicque baño LED

Montaje en **armarios, paredes y espejos**. Ideal para baños u otras estancias. Incluye interruptor.
Material: **aluminio + PC**. Cable: 300mm. **IK04**.

Referencia	Con difusor / Luminaria (360°)	Sin difusor / Fuente de luz (360°)	Luz	Dimensión (AxBxC)	Embalaje
203800041	8W / 640Lm	7.4W / 900Lm	● 4000K	400x112x44mm	20
203800042	8W / 640Lm	7.4W / 900Lm	● 6500K	400x112x44mm	20
203800043	12W / 960Lm	11W / 1350Lm	● 4000K	600x106x42mm	20
203800044	12W / 960Lm	11W / 1350Lm	● 6500K	600x112x44mm	20

Sioux
PANTALLAS



18W

36W

45W



Fácil
instalación

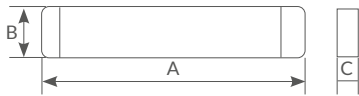

6500K



20.000



≥80Ra



30.000h.



IP65



220-240V



50/60Hz

Pantalla estanca LED

Tipo: **superficie**. **Fijación en techo**. Material: **PC**. Incluye 2 clips, 2 tornillos y 2 tacos.
Sin cable, fácil conexionado. **Protección contra rayos UV**. Uso interior y exterior. **IK8**.

Referencia	Con difusor / Luminaria (360°)	Sin difusor / Fuente de luz (360°)	Luz	Dimensión (AxBxC)	Embalaje
203200008	18W / 1600Lm	18W / 1900Lm	● 6500K	700x53x35mm	20
203200009	36W / 3500Lm	36W / 4000Lm	● 6500K	1230x53x35mm	20
203200010	45W / 4300Lm	45W / 4900Lm	● 6500K	1530x53x35mm	20

Lepola

REGLETAS

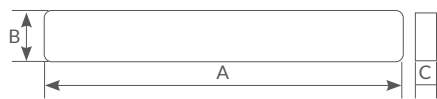

-  6500K
-  120°
-  20.000
-  ≥80Ra
-  30.000h.
-  220-240V
-  50/60Hz

Regleta techo LED

Fijación en techo. Preparado para interconectar varias entre sí. Material: **ABS + PC.** Uso exterior. **IP65.**

Referencia	Con difusor / Luminaria (360°)	Sin difusor / Fuente de luz (360°)	Luz	Máx. regletas interconectadas	Dimensión (AxBxC)	Embalaje
203820001	9W / 900Lm	9W / 1100Lm	● 6500K	27	540x60x58mm	20
203820003	18W / 1800Lm	18W / 2400Lm	● 6500K	13	1140x60x58mm	15
203820005	24W / 2400Lm	24W / 3200Lm	● 6500K	10	1440x60x58mm	12

Tupala

REGLETAS

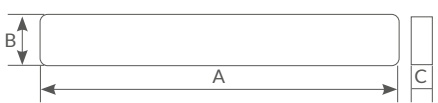

-  6500K
-  120°
-  20.000
-  ≥80Ra
-  30.000h.
-  220-240V
-  50/60Hz

Regleta techo LED

Fijación en techo. Con cable para interconectar entre sí. Material: **ABS + PC.** Uso exterior. **IP65.**

Referencia	Con difusor / Luminaria (360°)	Sin difusor / Fuente de luz (360°)	Luz	Máx. regletas interconectadas	Dimensión (AxBxC)	Embalaje
203820002	18W / 1800Lm	18W / 2400Lm	● 6500K	13	540x78x58mm	15
203820004	36W / 3600Lm	36W / 4600Lm	● 6500K	12	1140x78x58mm	8
203820006	48W / 4800Lm	48W / 6200Lm	● 6500K	9	1440x78x58mm	12

Kiowa
PANTALLAS

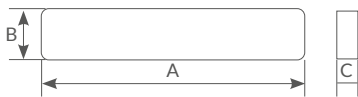
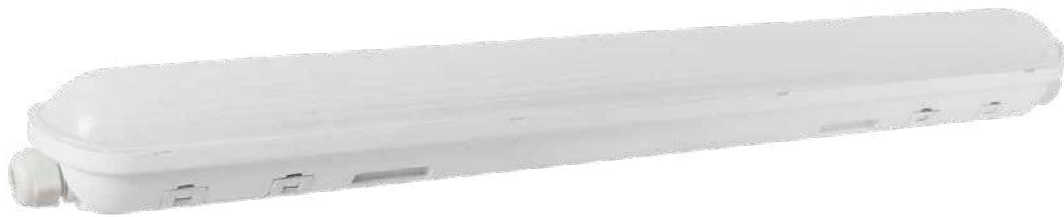

- 6500K
- 30.000
- ≥80Ra
- 50.000h.
- IP65
- 220-240V
- 50/60Hz

Pantalla estanca LED

Tipo: **superficie**. **Fijación en techo**. Material: **PC+ABS**. Incluye 2 clips, 2 tornillos y 2 tacos.
Sin cable, fácil conexionado. **Protección contra rayos UV**. Uso interior y exterior. **IK8**.

Referencia	Con difusor / Luminaria (360°)	Sin difusor / Fuente de luz (360°)	Luz	Dimensión (AxBxC)	Embalaje
203200011	12W / 1440Lm	12W / 1600Lm	6500K	590x72x61mm	20
203200012	24W / 2880Lm	24W / 3300Lm	6500K	1180x72x61mm	15
203200013	33W / 3960Lm	33W / 4600Lm	6500K	1480x72x61mm	12

Atende
REGLETAS

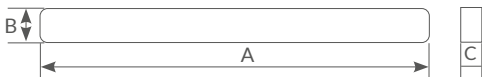

Regleta industrial para tubos LED

Para tubos LED T8. Carcasa **metálica**. Casquillo: G13.
Conexionadas en un lateral para instalar tubos de LED a 230V directo. Uso interior.

Referencia	Para tubo (cm)	Tipo de tubo	Dimensión (AxBxC)	Embalaje
203810010	1 x 60cm	T8	599x32x44mm	60
203810011	1 x 120cm	T8	1199x32x44mm	60
203810012	1 x 150cm	T8	1500x32x44mm	60



60cm

120cm

150cm

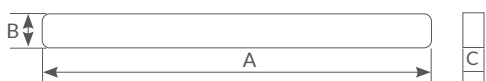

IP20



220-240V



50Hz

Regleta industrial para tubos LED

Para tubos LED T8. Carcasa **metálica**. Casquillo: G13.
Conexionadas en un lateral para instalar tubos de LED a 230V directo. Uso interior.

Referencia	Para tubo (cm)	Tipo de tubo	Dimensión (AxBxC)	Embalaje
203810005	2 x 60cm	T8	599x72x40mm	60
203810006	2 x 120cm	T8	1199x72x40mm	60
203810007	2 x 150cm	T8	1500x72x40mm	60



9W

18W

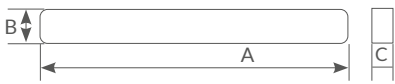

6500K



160°



15.000



≥80Ra



35.000h.



IP20



165-260V



50/60Hz

Regleta industrial con tubo LED

Fijación en techo. Material tubo: **nanoplástico.** Material regleta: **metal.** Uso interior.

Referencia	Con difusor / Luminaria (360°)	Sin difusor / Fuente de luz (360°)	Luz	Máx. regletas interconectadas	Dimensión (AxBxC)	Embalaje
203810008	9W / 810Lm	9W / 1100Lm	● 6500K	27	599x32x44mm	24
203810009	18W / 1620Lm	18W / 2400Lm	● 6500K	13	1199x32x44mm	24



A Para un tubo

60cm 120cm 150cm



B Para 2 tubos

60cm 120cm 150cm



C Bolsa accesorios

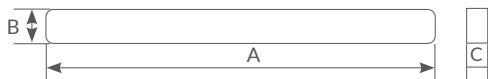

Pantalla estanca LED



IP65



220-240V



50Hz

Para tubos fluorescentes T8. Estructura **ABS** y **tapa policarbonato**.
 Conexionadas **para instalar tubos de LED a 230V directo**. Uso interno y externo.

Referencia	Artículo	Para tubo (cm)	Tipo de tubo	Dimensión (AxBxC)	Embalaje
203200014	A	1x 60cm	T8	650x80x90mm	10
203200015	A	1x 120cm	T8	1250x80x90mm	8
203200016	A	1x 150cm	T8	1550x80x90mm	8
203200017	B	2x 60cm	T8	650x150x90mm	6
203200018	B	2x 120cm	T8	1250x150x90mm	6
203200019	B	2x 150cm	T8	1550x150x90mm	4
203215007	C	Bolsa 10 clips, tornillos y enganches			

* Consulta el conexionado en el apartado info técnica.



Nuka

CON PINZA

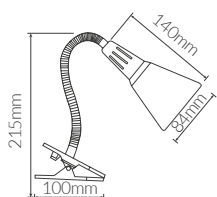

Interior Flexos



Hz

220-240V 50Hz

Flexo con pinza

Compatible con **LED** y **bajo consumo**. Con cable e interruptor.
Con **pinza de sujeción**. **Acabado mate**. Material: **metal**. Fácil montaje.

Referencia	Potencia	Casquillo	Color	Embalaje
204200000	Máx. 40W	E14	○ Blanco	20
204200001	Máx. 40W	E14	● Negro	20
204200002	Máx. 40W	E14	● Rosa	20
204200003	Máx. 40W	E14	● Amarillo	20

Saidu
CON PINZA

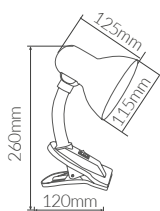

Interior Flexos

Flexo con pinza

220-240V 50Hz

Compatible con **LED** y **bajo consumo**. Con cable e interruptor.
Con **pinza de sujeción**. Material: **metal**. Fácil montaje.

Referencia	Potencia	Casquillo	Color	Embalaje
204200031	Máx. 40W	E27	● Gris	12
204200032	Máx. 40W	E27	○ Blanco	12
204200033	Máx. 40W	E27	● Negro	12
204200034	Máx. 40W	E27	● Rojo	12



Bell

SOMBREMESA

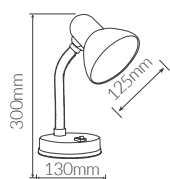

Interior Flexos

Flexo sobremesa

220-240V 50Hz

Compatible con **LED** y **bajo consumo**. Con cable e interruptor.
Material: **metal**. Fácil montaje.

Referencia	Potencia	Casquillo	Color	Embalaje
001900413	Máx. 40W	E27	○ Blanco	12
001900414	Máx. 40W	E27	● Negro	12
001900415	Máx. 40W	E27	● Gris	12
001900416	Máx. 40W	E27	● Turquesa	12
001900417	Máx. 40W	E27	● Azul	12
001900418	Máx. 40W	E27	● Rojo	12

Simbu

SOMBREMESA

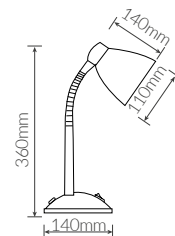

220-240V 50Hz

Flexo sobremesa

Compatible con **LED** y **bajo consumo**. Con cable e interruptor en la base.
Acabado mate. Material: **metal**. Fácil montaje.

Referencia	Potencia	Casquillo	Color	Embalaje
204200022	Máx. 40W	E14	● Gris antracita	12
204200023	Máx. 40W	E14	● Amarillo	12

Nenet

SOMBREMESA

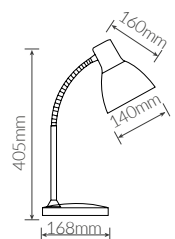

220-240V 50Hz

Flexo sobremesa

Compatible con **LED** y **bajo consumo**. Con cable e interruptor en la base.
Acabado mate. Material: **metal**. Fácil montaje.

Referencia	Potencia	Casquillo	Color	Embalaje
204200024	Máx. 40W	E27	○ Blanco	6
204200025	Máx. 40W	E27	● Negro	6
204200026	Máx. 40W	E27	● Gris	6

Nuba

SOMBREMESA

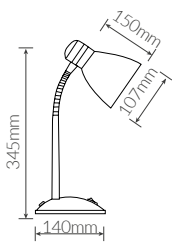

Flexo sobremesa



 220-240V 50Hz

Compatible con **LED** y **bajo consumo**. Con cable e interruptor en la base.
Acabado mate. Material: **metal**. Fácil montaje.

Referencia	Potencia	Casquillo	Color	Embalaje
204200017	Máx. 40W	E27	○ Blanco	12
204200018	Máx. 40W	E27	● Negro	12
204200019	Máx. 40W	E27	● Gris	12
204200020	Máx. 40W	E27	● Verde	12
204200021	Máx. 40W	E27	● Rosa	12

Focus

SOMBREMESA

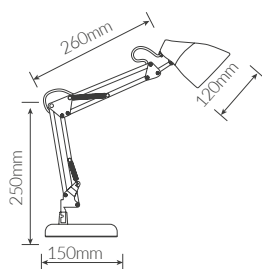

Flexo sobremesa



220-240V



50Hz

Compatible con **LED** y **bajo consumo**.
Con cable e interruptor en el cabezal. Material: **metal**. Fácil montaje.

Referencia	Potencia	Casquillo	Color	Embalaje
001801664	Máx. 40W	E27	○ Blanco	6
001801665	Máx. 40W	E27	● Negro	6



Tradition

SOMBREMESA

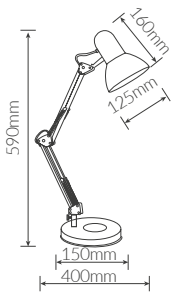

220-240V 50Hz

Flexo sobremesa

Compatible con **LED** y **bajo consumo**.
Con cable e interruptor en el cabezal. Material: **metal**. Fácil montaje.

Referencia	Potencia	Casquillo	Color	Embalaje
001900423	Máx. 40W	E27	○ Blanco	6
001900424	Máx. 40W	E27	● Negro	6
001900425	Máx. 40W	E27	● Rojo	6

Nahua

SOMBREMESA

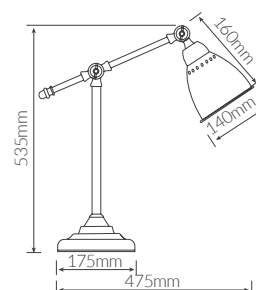

220-240V

50Hz

Flexo sobremesa

Compatible con **LED** y **bajo consumo**. Con cable e interruptor.
Acabado brillo. Material: **metal**. Fácil montaje.

Referencia	Potencia	Casquillo	Color	Embalaje
204200004	Máx. 40W	E27	● Níquel	4
204200005	Máx. 40W	E27	● Bronce	4

Himba

SOMBREMESA

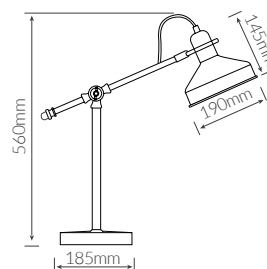

220-240V

50Hz

Flexo sobremesa

Compatible con **LED** y **bajo consumo**.
 Con cable e interruptor. Material: **metal**. Fácil montaje.

Referencia	Potencia	Casquillo	Color	Embalaje
204200006	Máx. 40W	E27	● Gris	1
204200007	Máx. 40W	E27	● Verde	1

Dinka

SOMBREMESA

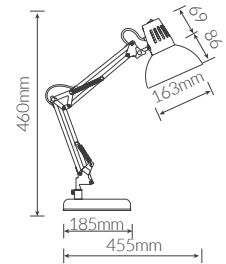

220-240V 50Hz

Flexo sobremesa

Compatible con **LED** y **bajo consumo**. Con cable e interruptor en el cabezal.
Material: **metal**. Fácil montaje.

Referencia	Potencia	Casquillo	Color	Embalaje
204200008	Máx. 40W	E27	○ Blanco	6
204200009	Máx. 40W	E27	● Negro	6
204200010	Máx. 40W	E27	● Gris	6

Mursi

SOMBREMESA

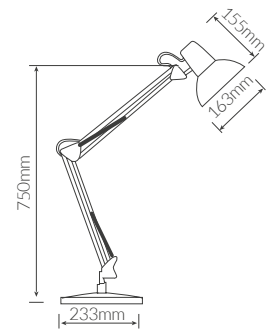

220-240V 50Hz

Flexo sobremesa

Compatible con **LED** y **bajo consumo**. Con cable e interruptor en el cabezal.
Acabado mate. Material: **metal**. Fácil montaje.

Referencia	Potencia	Casquillo	Color	Embalaje
204200013	Máx. 40W	E27	● Gris	1

Surma

SOMBREMESA

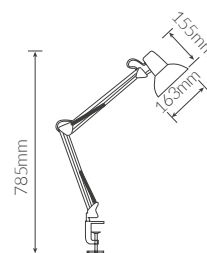

Flexo sobremesa



220-240V



50Hz

Compatible con **LED** y **bajo consumo**. Con cable e interruptor en el cabezal.
Material: **metal**. Con sujeción para mesa. Fácil montaje.

Referencia	Potencia	Casquillo	Color	Embalaje
204200014	Máx. 40W	E27	○ Blanco	6
204200015	Máx. 40W	E27	● Negro	6
204200016	Máx. 40W	E27	● Gris	6

Clip SOMBREMESA

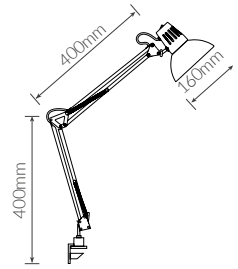

220-240V



50Hz

Flexo sobremesa

Compatible con **LED** y **bajo consumo**.
Con sujeción para mesa. Material: **metal**. Fácil montaje.

Referencia	Potencia	Casquillo	Color	Embalaje
001900396	Máx. 40W	E27	○ Blanco	12
001900397	Máx. 40W	E27	● Negro	12
001900398	Máx. 40W	E27	● Rojo	12

Zulu PARED

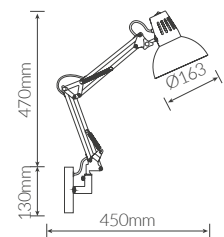

220-240V



50Hz

Flexo pared

Compatible con **LED** y **bajo consumo**. Con cable e interruptor en el cabezal.
Material: **metal**. Instalación en pared. Fácil montaje.

Referencia	Potencia	Casquillo	Color	Embalaje
204200027	Máx. 40W	E27	○ Blanco	12
204200028	Máx. 40W	E27	● Negro	12

Hamu

SOMBREMESA

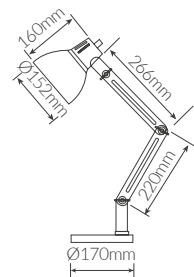

Hz

220-240V 50/60Hz

Flexo sobremesa

Compatible con **LED** y **bajo consumo**. Con cable e interruptor.
 Con **3 reguladores** para modificar la **inclinación**.
 Material: **cuerpo de madera**. Fácil montaje. Cable: 1.6M.

Referencia	Potencia	Casquillo	Color	Embalaje
204200029	Máx. 11W	E27	○ Blanco	6
204200030	Máx. 11W	E27	● Negro	6

Susua

SOMBREMESA



EPISTAR LED CHIP

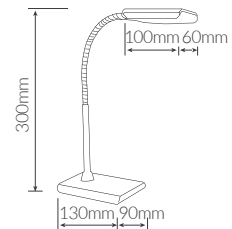

Flexo sobremesa



5000K



120°



10.000



≥80Ra



25.000h.



IP20



220-240V



50/60Hz

Orientable. Material: **ABS + metal.** Fácil montaje.

Referencia	Con difusor / Luminaria	Sin difusor / Fuente de luz (360°)	Luz	Color	Embalaje
204205005	6W/400Lm	6.6W/455Lm	● 5000K	○ Blanco	8
204205006	6W/400Lm	6.6W/455Lm	● 5000K	● Negro	8
204205002	6W/400Lm	6.6W/455Lm	● 5000K	● Gris	8

Mawai

SOMBREMESA

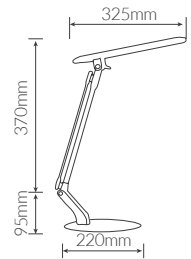

Flexo LED sobremesa

- 6000K
- 120°
- 10.000
- ≥80Ra
- 20.000h.
- IP20
- 100-240V
- 50Hz

Orientable. Material: **ABS + metal.** Cable con **interruptor.** Color: gris. Fácil montaje.

Referencia	Con difusor / Luminaria	Sin difusor / Fuente de luz (360°)	Luz	Embalaje
vv	5W / 307Lm	4W / 390Lm	6000K	6

Karoi

SOMBREMESA



Con batería
1200mAh

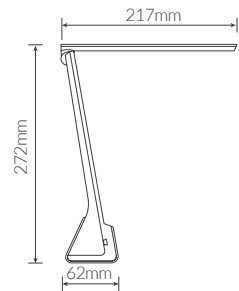

Flexo LED sobremesa

- 4000K
- 120°
- 10.000
- ≥80Ra
- 25.000h.
- IP20
- 220-240V
- 50Hz

Orientable. Con **3 niveles de intensidad:** intensidad **baja** (3h. autonomía), intensidad **media** (2.5h. autonomía), intensidad **máxima** (1.5h. autonomía). Con batería 1200mAh. Cable USB 1M.

Referencia	Potencia	Lúmenes	Luz	Embalaje
204205007	4W	200Lm	4000K	24



Rasele

SOMBREMESA



*Sugerencia de presentación.

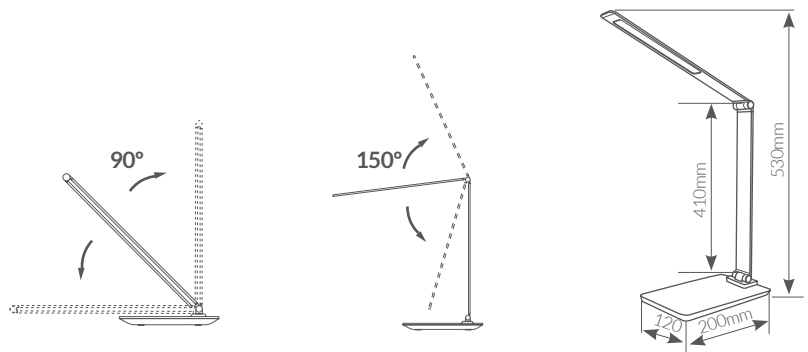

Flexo LED sobremesa

- 
120°
- 
10.000
- 
≥80Ra
- 
25.000h.
- 
IP20
- 
220-240V
- 
50/60Hz





Orientable 150°. Regulable en temperatura e intensidad. 5 niveles de intensidad. Botón táctil. Material ABS.
Función memoria. Incluye temporizador eco: se apaga después de 4h de funcionamiento. **Puerto USB para cargar dispositivos.**

Referencia	Con difusor / Luminaria	Sin difusor / Fuente de luz (360°)	Luz	Color	Embalaje
204205010	10W / 675Lm	8W / 820Lm	CCT	● Gris	8

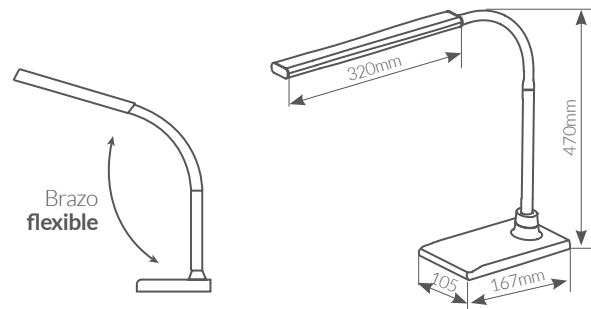
Limba

SOMBREMESA



-  120°
-  10.000
-  ≥80Ra
-  25.000h.
-  IP20
-  220-240V
-  50/60Hz

Flexo LED **sobremesa**

Orientable. Regulable en temperatura e intensidad. 3 niveles de intensidad. Botón táctil. Material ABS.
Función memoria. Incluye interruptor en la base.

Referencia	Con difusor / Luminaria	Sin difusor / Fuente de luz (360°)	Luz	Color	Embalaje
204205008	7W / 400Lm	6W / 600Lm	CCT	○ Blanco	8
204205009	7W / 400Lm	6W / 600Lm	CCT	● Negro	8
204295003	Recambio driver 6W para flexo Limba ref. 204205008 - 09				



Batua

SOMBREMESA



Flexo LED sobremesa

- 5000K
- 120°
- 10.000
- ≥80Ra
- 25.000h.
- IP20
- 220-240V
- 50Hz

Orientable 150°. Regulable en 3 intensidades.
Pantalla LED que muestra la **hora, la temperatura y el día.**
 Con **alarma y calendario.** Incluye una pila CR2032 (3V).
 Diseño elegante, ideal para oficinas.

Referencia	Con difusor / Luminaria	Sin difusor / Fuente de luz (360°)	Luz	Embalaje
204205001	7W / 260Lm	5W / 282Lm	● 5000K	8

Baliko

LÁMP. AUMENTO

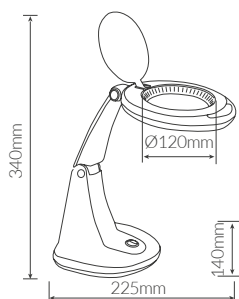

6500K



120°



10.000



≥80Ra



25.000h.



IP20



220-240V



50Hz

Lámpara LED lente 3 aumentos

Incorpora **visera abatible** para resguardarla del polvo.
Brazo regulable. Diámetro lupa: Ø120mm. LED SMD.
Visión óptica: 3D.

Referencia	Con difusor / Luminaria	Sin difusor / Fuente de luz (360°)	Luz	Color	Embalaje
204205014	6W / 450Lm	6W / 500Lm	● 6500K	○ Blanco	8

Mongu

LÁMP. AUMENTO

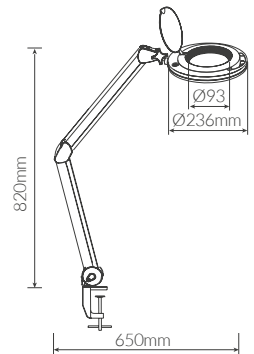

6500K



120°



10.000



≥80Ra



25.000h.



IP20



220-240V



50Hz

Lámpara LED lente 3 aumentos

Incorpora **visera abatible** para resguardarla del polvo.

Brazo regulable. Diámetro lupa: Ø93mm.

LED SMD. **Visión óptica: 3D.**

Referencia	Con difusor / Luminaria	Sin difusor / Fuente de luz (360°)	Luz	Color	Embalaje
204205015	8W / 650Lm	8W / 720Lm	● 6500K	○ Blanco	4

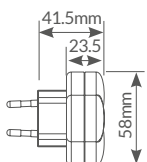

Luz de noche de neón



230V

Tipo: **neón**. Ideal para habitaciones, garajes, escaleras, etc. Blíster.

Referencia	Potencia	Luz	Embalaje
001303394	1W	2000K	10/100

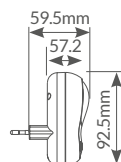

Luz de noche LED + Interruptor



230V

Ideal para habitaciones, garajes, escaleras, etc. Blíster.

Referencia	Potencia	Embalaje
001303395	1W	10/100

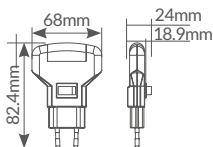

Luz de noche LED + Interruptor



230V

Ideal para habitaciones, garajes, escaleras, etc. Blíster.

Referencia	Potencia	Embalaje
001300034	1W	10/100

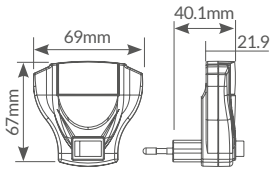

Luz de noche LED ángulo recto + Interruptor

Ideal para habitaciones, garajes, escaleras, etc. Blíster.

Referencia	Potencia	Embalaje
001301230	1W	10/100

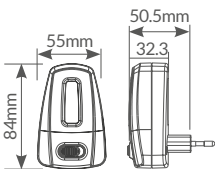

Luz de noche LED + Interruptor

Tipo: **neón**. Ideal para habitaciones, garajes, escaleras, etc. Vida: 6.000h. Blíster.

Referencia	Potencia	Luz	Embalaje
202805000	1W	● 6400K	10/100

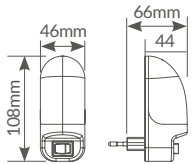

230V

Luz de noche LED + Interruptor

Ideal para habitaciones, garajes, escaleras, etc. Blíster.

Referencia	Potencia	Embalaje
001301229	1W	10/100

Interior Luces de noche



Sensor movimiento & crepuscular



Luz indirecta

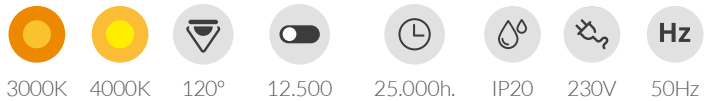
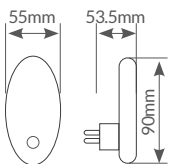

Luz de noche LED indirecta con sensor crepuscular + movimiento

Material: PC. Sensor crepuscular y de movimiento. Se enciende a los >20lux. Ángulo de detección: 110°. Tiempo encendido: 20'. Uso interior. Ideal para habitaciones, garajes, escaleras, etc. Blíster.

Referencia	Potencia	Lúmenes	Luz	Embalaje
202805005	0.65W	10Lm	● 3000K	10/80
202805006	0.65W	10Lm	● 4000K	10/80

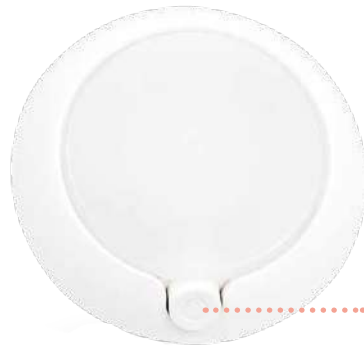

con Sensor
Sensor crepuscular

Botón ON/OFF

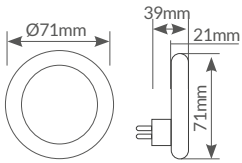

- 3000K
- 4000K
- 120°
- 12.500
- 25.000h.
- IP20
- 230V
- 50Hz

Luz de noche LED con sensor crepuscular

Material: **PC. Sensor crepuscular.** Se enciende a los >20lux.
Botón On/Off. Uso interior. Ideal para **habitaciones, garajes, escaleras,** etc. Blíster.

Referencia	Potencia	Lúmenes	Luz	Embalaje
202805001	0.28W	3Lm	3000K	80
202805002	0.28W	3Lm	4000K	80



con Sensor
Sensor crepuscular

Luz indirecta

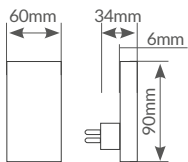

- 3000K
- 4000K
- 120°
- 12.500
- 25.000h.
- IP20
- 230V
- 50Hz

Luz de noche LED indirecta con sensor crepuscular

Material: **PC. Sensor crepuscular.** Se enciende a los >20lux.
Uso interior. Ideal para **habitaciones, garajes, escaleras,** etc. Blíster.

Referencia	Potencia	Lúmenes	Luz	Embalaje
202805003	0.28W	3Lm	3000K	10/80
202805004	0.28W	3Lm	4000K	10/80



con Sensor **Sensor movimiento crepuscular**

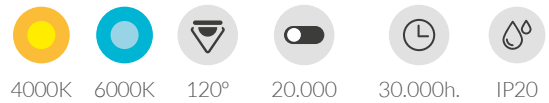
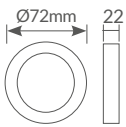

Luz de armario LED con **sensor de movimiento crepuscular**

Material: **PC. Sensor de movimiento crepuscular. Distancia de detección 3.5M. Ángulo de detección: 100°.**
 Tiempo de encendido: 30'. Uso interior. Utiliza 3 pilas AAA (no incluidas). Cinta adhesiva 3M.

Referencia	Potencia	Lúmenes	Luz	Embalaje
203000004	0.5W	35Lm	● 4000K	50
203000005	0.5W	35Lm	● 6000K	50

con Sensor **Sensor movimiento & crepuscular**

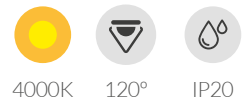
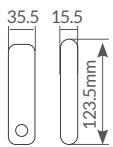

Luz de armario **LED con sensor crepuscular + movimiento**

Material: **ABS. Sensor crepuscular y de movimiento. Se enciende a los >20lux. Tiempo de encendido: 20'. Ángulo de detección: 110°. Botón On/Off.** Uso interior. Cinta adhesiva 3M (incluida). Utiliza 4 pilas AAA (no incluidas). Blíster.

Referencia	Potencia	Lúmenes	Luz	Embalaje
203000001	0.8W	40Lm	● 4000K	10/80

Intensidad regulable

Botón ON/OFF

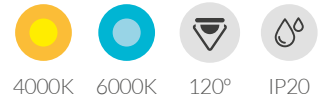
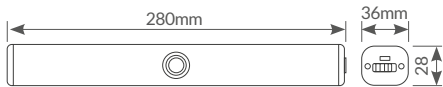

Luz de armario LED regulable

Material: **PC, ABS y aluminio**. Botón On/Off. **Intensidad regulable**. **Cargador USB**.
Autonomía: 3.5h (100%), 4h. (50%), 6h. (25%). Color: blanco.
Con imán, gancho para colgar y cinta adhesiva 3M. Batería 3000mAh 3.7V. Uso interior.

Referencia	Potencia	Lúmenes	Luz	Embalaje
203005001	4W	320Lm	● 4000K	40
203005002	4W	320Lm	● 6000K	40

Sensor giratorio 90°



Sensor movimiento & crepuscular

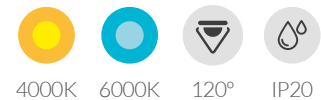
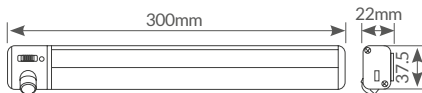

Luz de armario LED con sensor crepuscular + movimiento

Material: **PC, ABS y aluminio**. **Sensor crepuscular y de movimiento**. **Ángulo de detección: 90°**.
Con 3 modos: On / Off / Automático. Tiempo de encendido: 30'. **Cargador USB**. **Sensor giratorio 90°**.
Con imán y cinta adhesiva 3M. Batería 1800mAh 3.7V. Uso interior.

Referencia	Potencia	Lúmenes	Luz	Embalaje
203000002	2.5W	200Lm	● 4000K	40
203000003	2.5W	200Lm	● 6000K	40



con Sensor **Sensor movimiento & crepuscular**

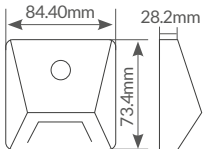

Baliza escalera LED con sensor crepuscular + movimiento

4000K 120° IP54

Material: **ABS. Sensor crepuscular y de movimiento.** Se enciende a los >20lux. Tiempo de encendido: 20'. **Ángulo de detección:** 110°. Uso interior. Cinta adhesiva 3M (incluida). Utiliza 3 pilas AAA (no incluidas). Blíster.

Referencia	Potencia	Lúmenes	Luz	Embalaje
202800002	0.25W	10Lm	● 4000K	20/80

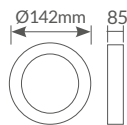

Puslight LED redondo

Ideal para habitaciones, garajes, escaleras, etc. Pilas no incluidas. Blíster.

Referencia	Pilas	Embalaje
001300514	4x AA	36/72

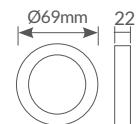

Pushlight LED COB redondo

Tipo LED: **COB.** Luz: blanca. Montaje: adhesivo. Pilas no incluidas. Blíster.

Referencia	Lúmenes	Pila	Embalaje
203005000	80Lm	3xAAA	100



Luz de armario LED + Interruptor

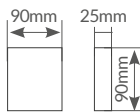

Luz de armario LED + Interruptor

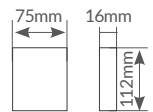

Display 12 unidades.

Pilas incluidas. Montaje: a tornillos y/o adhesivo. Ideal como luz de noche. Para armarios.

Display 12 unidades. Tipo LED: COB.

Montaje: a tornillos y/o adhesivo. Pilas incluidas.

Referencia	Potencia	Lúmenes	Pila	Embalaje
203005005	3W	180Lm	3xAAA	12/48

Referencia	Potencia	Lúmenes	Pila	Embalaje
203005004	1W	180Lm	4xAAA	12/48



Sensor movimiento

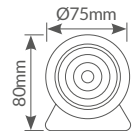

Luz LED COB + sensor movimiento

Display 6 unidades.

Con imán base. Material: ABS. Modos: ON / OFF / Auto. Montaje con tornillos y/o cinta adhesiva de 3cm (cinta incluida).

Incluye 3 pilas alcalinas AAA. Distancia detección: 4M. Tiempo de encendido: 25 seg. Ángulo detección: 180°.

Ángulo rotación: 360°. Se enciende cuando hay menos de 15lux en la estancia.

Referencia	Potencia	Lúmenes	Pila	Embalaje
001303231	2W	120Lm	3xAAA	6/54



A



B



C



D

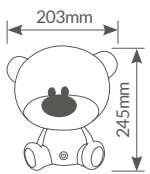

Profundidad: 203mm

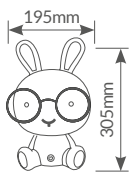

Profundidad: 165mm

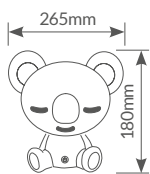

Profundidad: 255mm

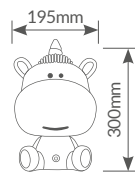

Profundidad: 180mm



4000K



20.000h.



IP20



100-240V



50/60Hz

Luz de noche infantil LED

3 modos de intensidad. Botón táctil. Cable USB 1M (incluido).

Material: ABS + PP. Enchufe 5V-(0.5-1A) (No incluido). Voltaje entrada DC 5V. Ideal como luz de noche.

Referencia	Artículo	Modelo	Potencia	Lúmenes	Color	Embalaje
202805008	A	Osito	2.5W	50/70/120Lm	● Azul	12
202805009	B	Conejito	2.5W	50/70/120Lm	● Rosa	12
202805010	C	Koala	2.5W	50/70/120Lm	● Azul	12
202805011	D	Unicornio	2.5W	50/70/120Lm	● Rosa	12



A



B



C



D



E



Luz de noche **infantil LED recargable**

3 modos de intensidad. Botón táctil. Cable USB 1M (incluido). **Material:** ABS + PP.
Recargable. Funciona con **corriente AC** y/o **batería recargable 1200mAh (incluida)**. Enchufe 5V-(0.5-1A) (No incluido).
 Voltaje entrada DC 5V. Ideal como luz de noche.

Referencia	Artículo	Modelo	Potencia	Lúmenes	Embalaje
202800006	A	Ovejita	2.5W	70 (RGB) / 70-120Lm (4000K)	12
202800007	B	Panda	2.5W	70 (RGB) / 70-120Lm (4000K)	12
202800008	C	Koala	2.5W	70 (RGB) / 70-120Lm (4000K)	12
202800009	D	Conejito	2.5W	70 (RGB) / 70-120Lm (4000K)	12
202800010	E	Osito	2.5W	70 (RGB) / 70-120Lm (4000K)	12



Exterior

Iluminación

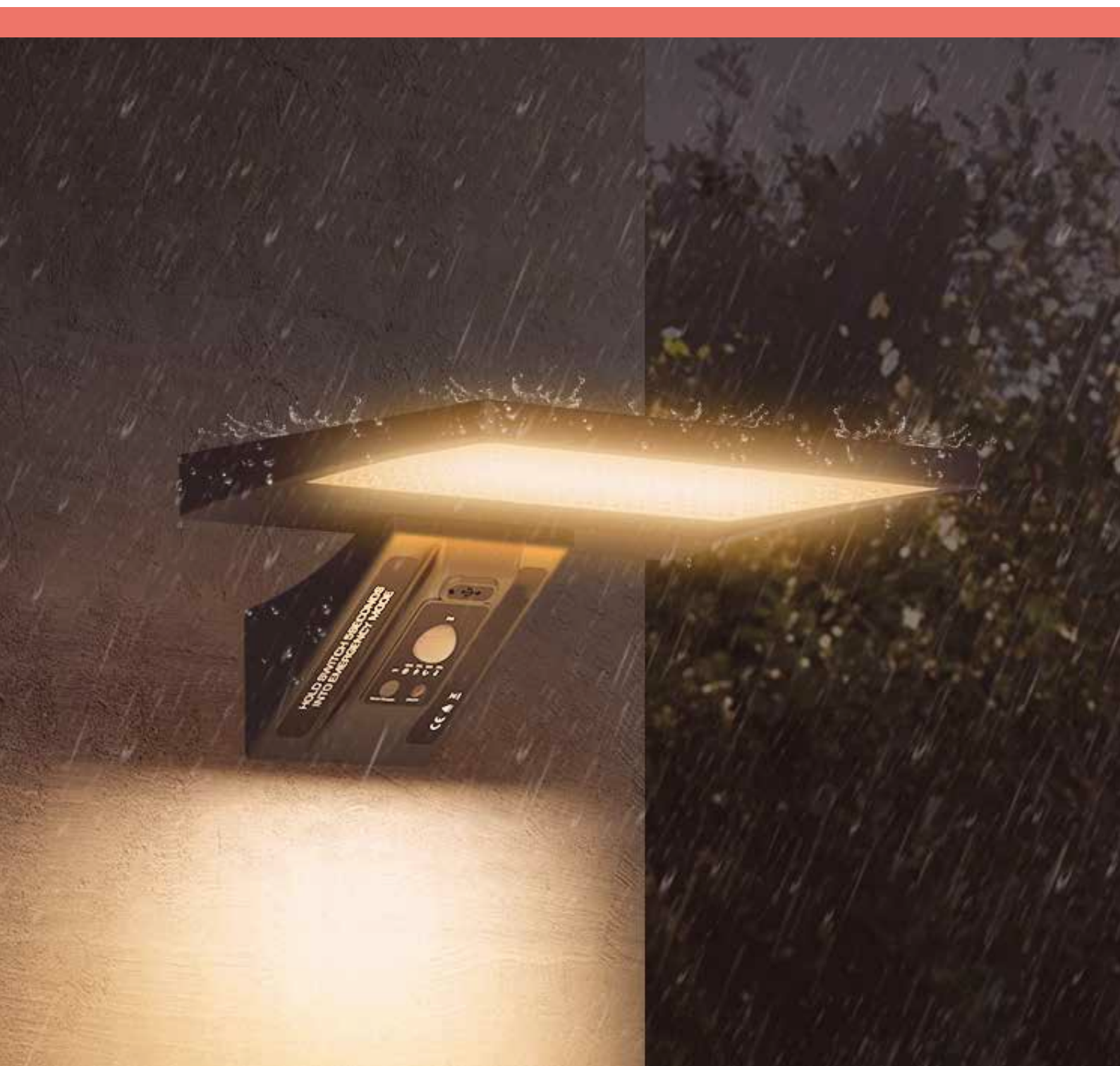

Kumira

PROYECTOR

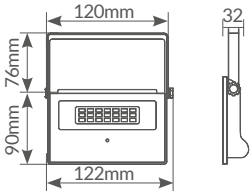

Posibilidad de colocar con estaca*

*Se vende por separado

Exterior Solar

Mini proyector solar LED con sensor

- 6500K
- 120°
- ≥80Ra
- 12.500h.
- IP65

Material: **aluminio + vidrio**. Color: **negro**. Autonomía: máx. 10-12h. Botón On/Off.
Tiempo de carga: 5-8h. **Área detección:** <5M. **Ángulo de detección:** 120°. Se apaga a los >120-130lux.
 Se enciende a los <10lux. **Altura de instalación:** <3M. **Batería:** 2.000mAh Li-Ion DC 3.7V. **Panel solar:** 6V.
 Panel monocristal 5.5V. Uso exterior. **IK08**.

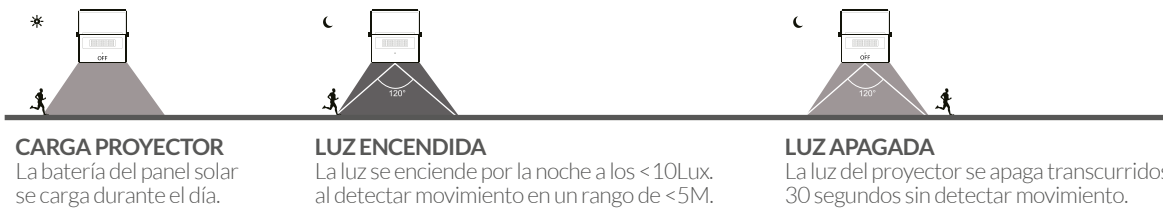

Referencia	Potencia	Panel	Lúmenes	Luz	Embalaje
202615011	7W ≈ 60W	1.4W	860Lm	● 6500K	40
202625001	Estaca para proyector solar ref. 202615011				

Kumira

PROYECTOR

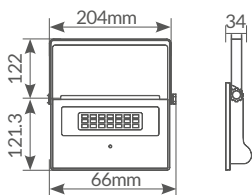

Posibilidad de colocar con estaca*

*Se vende por separado

Proyector solar LED con sensor

- 6500K
- 120°
- ≥80Ra
- 12.500h.
- IP65

Material: **aluminio + vidrio**. Color: **negro**. **Autonomía:** máx. 10-12h. Botón On/Off.

Tiempo de carga: 6-8h. **Área detección:** 6-8M. **Ángulo de detección:** 120°. Se apaga a los >120-130lux.

Se enciende a los <10lux. **Altura de instalación:** 4-6M. **Batería:** 2x2.600mAh Li-Ion DC 3.7V. **Panel solar:** 5.5V.

Panel monocristal. Uso exterior. **IK08**.

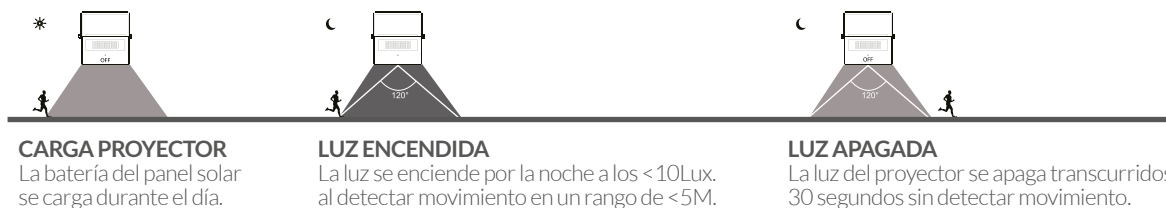

Referencia	Potencia	Panel	Lúmenes	Luz	Embalaje
202615020	15W	4W	1800Lm	● 6500K	16
202625001	Estaca para proyector solar ref. 202615011				

Rozale

PROYECTOR



Exterior Solar

10W
1300Lm

30W
4800Lm

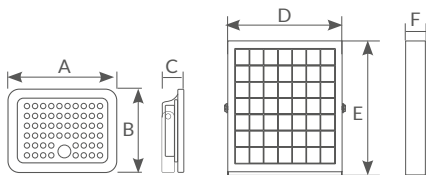

- 6000K
- 120°/60°
- ≥80Ra
- 30.000h.
- IP65

Proyector solar LED con sensor

Material: **ABS + PC**. 2 modos. Sensor de **movimiento**. Color: **negro**. **Autonomía**: hasta **60h.** (Modo A), **>10h.** (Modo B). **Temporizador**: 3-5-8h. **Tiempo de carga**: 4-6h. **Incluye mando a distancia** (utiliza 2 pilas AAA incluidas). Instalación en techo o en pared. **Distancia detección**: 6-8M. **Batería 10W**: Li-Ion 18650 / 3.600mAh / 3.7V (reemplazable). **Batería 30W**: LifePO4 battery 32.700 / 6000mAh / 6.4V (reemplazable). **Panel solar**: 6V. Panel monocristal. Cable: **5M**. Uso exterior. **IK08**.

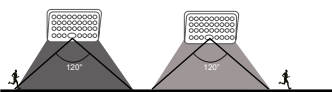

MODO A
LUZ AL 100%. Se enciende al anochecer al 100% cuando detectar movimiento, sino detecta presencia, a los 60 segundos la intensidad de la luz disminuye a un 10%.

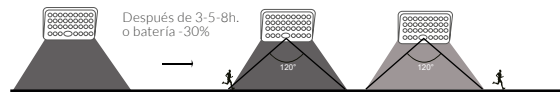

MODO B
TEMPORIZADOR. Se enciende automáticamente al anochecer y permanecerá encendido 3-5-8h. según las horas que se hayan seleccionado. Transcurrido ese tiempo o cuando la batería sea <30%, el proyector pasará al modo A.

Referencia	Potencia	Panel	Lúmenes	Luz	Dimensión (AxBxC)	Panel (DxExF)	Embalaje
202615007	10W	4.5W	1500Lm	● 6000K	152.7x143.8x32.3mm	202.1x220.9x24mm	12
202615008	30W	12.5W	4800Lm	● 6000K	199.7x189.9x49mm	254.2x350x41.8mm	8



Edara

PROYECTOR

2.5W ≈
50W

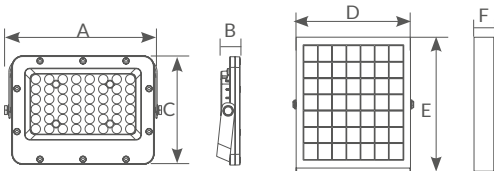

6500K



90°



≥80Ra



30.000h.



IP65

Proyector solar LED

Material: **aluminio**. Color: **gris**. **Autonomía**: máx. 7h. en días lluviosos. **Temporizador**: 3-5-8h.
Tiempo de carga: 5-8h. **Incluye mando a distancia** (utiliza 1 pila CR2032 incluida). Instalación en techo o en pared.
Batería: 5.000mAh / 3.2V. **Panel solar**: 6V. Panel monocristal. Cable: **1M**. Uso exterior. **IK08**.

Referencia	Potencia	Panel	Lúmenes	Luz	Dimensión (AxBxC)	Panel (DxFxE)	Embalaje
202615009	2.5W ≈50W	6W	420Lm	● 6500K	176.8x21.7x122mm	180x17x220mm	1

Samon
PROYECTOR



Exterior Solar



5W ≈ 30W 7W ≈ 60W

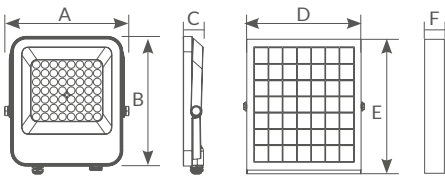

- 6500K
- 90°
- ≥70Ra
- 35.000h.
- IP65

Proyector solar LED

Material: **aluminio**. Color: **gris**. **Autonomía**: máx. 7h. en días lluviosos. **Temporizador**: 3-5-8h.
Tiempo de carga: 5-8h. **Incluye mando a distancia** (utiliza 1 pila CR2032 incluida). Instalación en techo o en pared.
Batería 30W: 10.000mAh. **Batería 60W**: 20.000mAh. **Panel solar**: 6V. Panel monocristal. Cable: **1M**. Uso exterior. **IK08**.

Referencia	Potencia	Panel	Lúmenes	Luz	Dimensión (AxBxC)	Panel (DxExF)	Embalaje
202615000	5W ≈ 30W	15W	720Lm	● 6500K	233x180x41.5mm	350x290x17mm	1
202615001	7W ≈ 60W	25W	1400Lm	● 6500K	278x220x41.5mm	450x350x17mm	1
202620003	Batería recambio para proyector 202615000						
202620004	Batería recambio para proyector 202615001						
202615002	Cable 1M para proyector solar						

Miloha

PROYECTOR



Más eficientes más sostenibles

Tiempo	Lm (3/6/8W)	Descarga
Inicial	400 / 900 / 1400Lm	100%
1h.	320 / 720 / 1120Lm	80%
3h.	200 / 450 / 700Lm	50%
6h.	120 / 270 / 420Lm	30%*
9h.	80 / 180 / 280Lm	20%*
12h.	160 / 360 / 560Lm	40%**

*Horas que la gente duerme

**Mayor intensidad cuando la gente se levanta

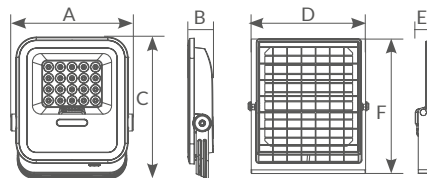

Proyector solar LED con sensor



Material: **ABS + cristal.** Autonomía: máx. 7días. Temporizador: 3-5-8h.

Encendido automático al anochecer. Intensidad regulable. Botón On/Off.

Tiempo de carga: 5-8h. Incluye mando a distancia (utiliza 1 pila CR2032 incluida). Instalación en techo o en pared.

Batería LiFePO4 reemplazable: 5.000mAh (3W) / 10.000mAh (6W) / 15.000mAh (8W).

Panel solar: 5V. Panel monocristal. Cable: 3M. Uso exterior. IK07.

Referencia	Potencia	Panel	Lúmenes	Luz	Dimensión (AxBxC)	Panel (DxExF)	Embalaje
202615015	3W ≈ 50W	6W	400Lm	● 6500K	219x46x253mm	210x17x200mm	10
202615016	6W ≈ 100W	10W	900Lm	● 6500K	243x46x282mm	300x17x205mm	10
202615017	8W ≈ 150W	15W	1400Lm	● 6500K	270x49x306mm	390x17x235mm	5
202615018	Cable (2x0.5mm) 2M para proyector solar Miloha ref. 202615015 - 16						
202615019	Cable (2x0.75mm) 2M para proyector solar Miloha ref. 202615017/202615017						



Con sensor de **movimiento** & modo luz constante

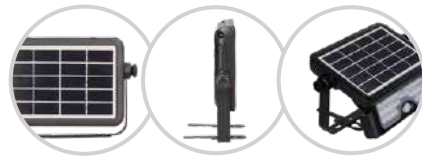

Instalación en pared

Proyector portátil

Varias posiciones

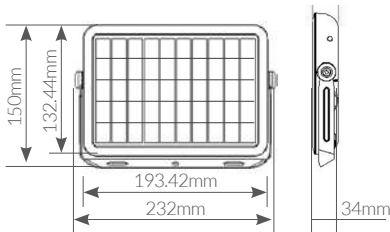

Proyector solar LED **multifunción con sensor**

Material: **ABS + PC + aluminio**. 2 modos: modo sensor de **movimiento** y modo **luz constante**. Color: **negro**. Uso exterior.
Ángulo de detección: 120°. **Radio de detección:** 6M. Batería Li-ion 18650 Li-Ion / 3.7V / 3000mAh (reemplazable).
Tiempo de carga: 8h. **Altura de instalación:** 4M. **Panel solar:** 2.3Wp monocristalino. **Protección contra rayos UV. IK8.**

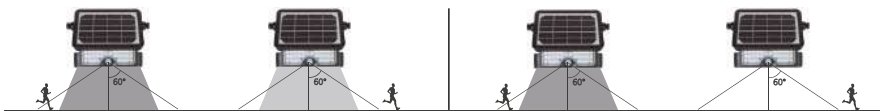

MODO SENSOR

A. BATERÍA >30%. Máximo brillo posible al detectar presencia, si no detecta presencia, brillo mínimo.

B. BATERÍA <30%. Máximo brillo posible al detectar presencia, si no detecta presencia, estará apagado.



MODO LUZ CONSTANTE

Presionar el botón de encendido durante 3 segundos y el proyector estará siempre encendido.

Referencia	Potencia	Lúmenes	Luz	Embalaje
200210000	5W	500Lm	● 4000K	18
200210001	5W	500Lm	● 6500K	18

Cela

FOCO PROYECTOR

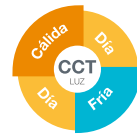

Con sensor de movimiento & crepuscular

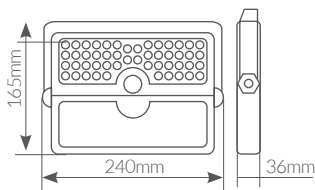
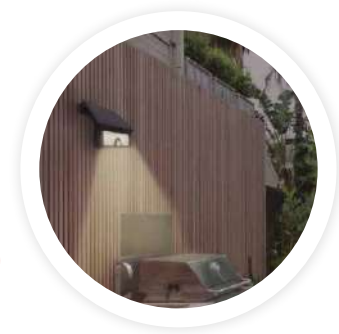

Instalación en pared

Proyector portátil

Varias posiciones



120°



50.000



≥80Ra



30.000h



IP65

Foco proyector solar LED con sensor

Material: **ABS + PC**. 3 modos: modo sensor de **movimiento** y modo **nocturno fijo** y **nocturno en movimiento**.

Cambio de tonalidad de luz a través de un botón. Color: **negro**. Uso exterior.

Ángulo de detección: 120°. **Radio de detección:** ≤6M. Batería Li-ion 18650 Li-Ion / 2.5-4.2V / 2200mAh (reemplazable).

Tiempo de carga: 6-8h. **Altura de instalación:** 3-5M. **Panel solar:** 5.5Wp monocristalino. **Protección contra rayos UV.** IK8.

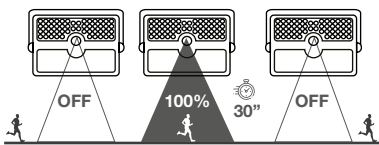

Modo A. Movimiento.

Luz apagada, cuando detecta presencia se enciende al 100%, si no detecta presencia a los 30 segundos la luz del foco se apaga automáticamente.

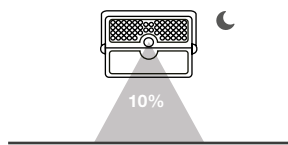

Modo B. Nocturno fijo.

Cuando anochece la luz se enciende al 10% automáticamente. Se mantiene así durante toda la noche.

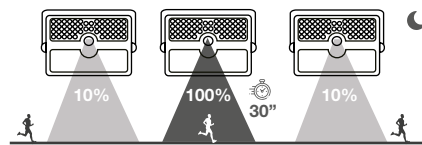

Modo C. Nocturno movimiento.

Cuando anochece la luz se enciende al 10% automáticamente, cuando detecta presencia se enciende al 100%, y a los 30 segundos vuelve al 10%.

Referencia	Potencia	Lúmenes	Luz	Embalaje
200210024	6W	600Lm	3000K-4200K-6000K	20



Lebon
APLIQUE



Exterior Solar

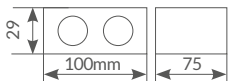

-  Luz cálida
-  120°
-  12.500
-  12.500h
-  IP44

Aplique solar LED con sensor crepuscular

Con 4 luces LED. 2 direcciones. Sensor crepuscular. Material: **ABS**. Color: **negro**. Botón On/Off. **Distancia de alumbrado:** 3M. Batería Ni-MH 600mAh. **Autonomía:** Máx. 10h. **Tiempo de carga:** mín. 6h. **Altura de instalación:** <3M. **Panel solar:** 2V / 120mAh. **Protección contra rayos UV.** IK06.

Referencia	Potencia	Lúmenes	Luz	Embalaje
200210023	4x0.25W	5Lm	 Luz cálida	8/32

Jankia

APLIQUE

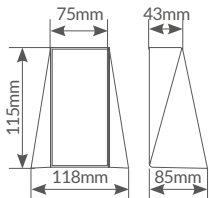

4200K



6500K



30°



15.000



≥80Ra



12.500h



IP54

Aplique solar LED

Material: **ABS**. Color: **negro**. Uso exterior. Botón On/Off.

Batería Li-ion 18650 Li-Ion / 3.7V / 1500mAh (no reemplazable). **Autonomía:** 10-12h. Se enciende a los <30lux.

Se apaga a los >120-130lux. **Tiempo de carga:** 5-8h. **Altura de instalación:** <3M. **Panel solar:** 1.3W / 6W monocristalino.

Protección contra rayos UV. IK06.

Referencia	Potencia	Lúmenes	Luz	Embalaje
200210021	2x2W	70Lm	● 4200K	30
200210022	2x2W	70Lm	● 6500K	30



Egoda

APLIQUE

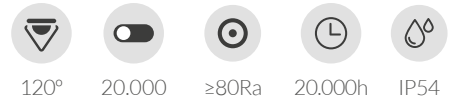
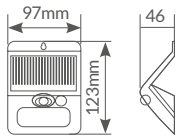

Aplique solar LED con sensor

Material: **ABS + PC**. 3 modos. Sensor de **movimiento** y **crepuscular**. Uso exterior.
Ángulo de detección: 120° **Área de detección:** 6M. Batería Li-ion 18650 / 3.7V 1200mAh.
Tiempo de carga: 6-8h. Encendido a los <30lux. Apagado a los >30lux. Botón On/Off.
Autonomía: 6-10h. / 150 detecciones (Modo A) / 6-8h. / sin detecciones (Modo B) / 4-8h. / 75 detecciones (Modo C).

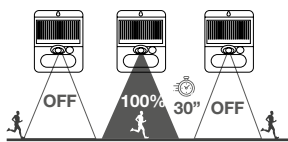

MODO A. Luz apagada, cuando detecta presencia se enciende al 100%, si no detecta presencia a los 30 segundos la luz se apaga automáticamente.

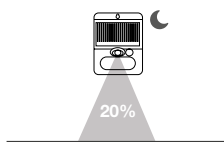

MODO B. Cuando anochece la luz se enciende al 20% automáticamente. Se mantiene así durante toda la noche.

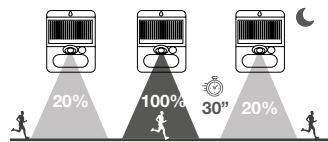

MODO C. Cuando anochece la luz se enciende al 20% automáticamente, cuando detecta presencia se enciende al 100%, y a los 30 segundos vuelve al 20%.

Referencia	Potencia	Lúmenes	Luz	Color	Embalaje
200210026	3W	350Lm	3000K-4000K-6500K	● Negro	48
200210027	3W	350Lm	3000K-4000K-6500K	○ Blanco	48

Kolam

APLIQUE



Opción carga
USB Tipo C

Con luz
trasera

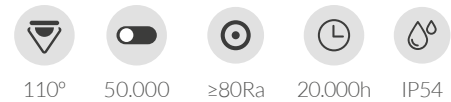
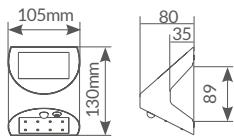

Aplicue solar LED con sensor

Material: **ABS + PC**. 2 modos. Sensor de **movimiento** y **crepuscular**. Uso exterior.

Ángulo de detección: 120°. **Área de detección:** 5M. Batería Li-ion 18650 / 3.7V 1200mAh.

Tiempo de carga: 10-13h. (Solar) / 2-2.5h. (USB). Encendido a los <10lux. Apagado a los >20lux. Botón On/Off.

Autonomía: 20h. / 120 detecciones (Modo A) / 7h. / 60 detecciones (Modo B). **Protección contra rayos UV.**

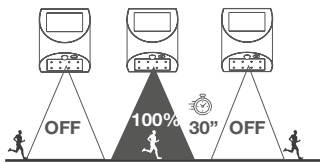

MODO A. Luz frontal apagada. Cuando detecta movimiento se enciende al 100%, a los 30 segundos se apaga. Luz trasera se enciende automáticamente desde el anochecer hasta el amanecer.

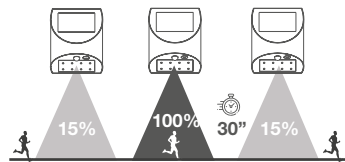

MODO B. Luz encendida al 15%. Cuando detecta movimiento se enciende al 100%, a los 30 segundos vuelve al 15%. Luz trasera se enciende automáticamente desde el anochecer hasta el amanecer.

Referencia	Potencia	Lúmenes	Luz	Color	Embalaje
200210028	3W	300Lm	● 4000K	● Negro	40
200210029	3W	300Lm	● 6000K	● Negro	40
200210030	3W	300Lm	● 4000K	○ Blanco	40
200210031	3W	300Lm	● 6000K	○ Blanco	40

Lukulu

APLIQUE

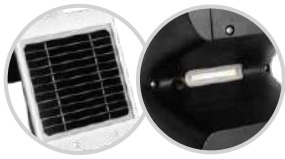

Luz trasera & frontal

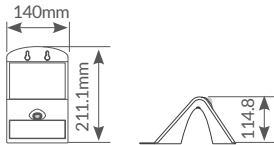

Exterior Solar

Aplique solar LED con sensor

- 3000K
- 6000K
- 90°
- 5.000
- ≥80Ra
- 30.000h
- IP65

Material: **ABS + PC, anti UV**. 2 modos. Sensor de **movimiento** y **crepuscular**. Uso exterior.
Ángulo de detección: 120°. **Radio de detección:** 3M. Batería Li-ion 18650 / 3.7V 2000mAh(reemplazables).
Tiempo de carga: 12h. **Protección contra rayos UV**. Encendido a los <30lux.
Autonomía: 35h. (Modo A) / 30h. (Modo B).

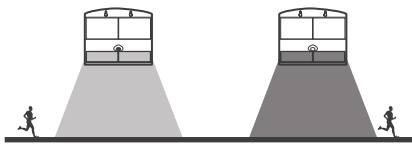

MODO A

Batería +30%. Luz tenue y cuando detecta movimiento se enciende al 100% durante 20 segundos.

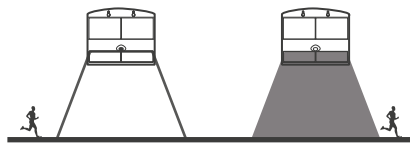

MODO B

Batería -30%. Luz apagada y cuando detecta movimiento se enciende al 100% durante 20 segundos.

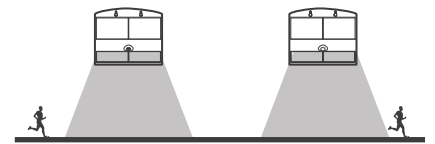

MODO B

Fijo. Luz fija siempre encendida al 50%.

Referencia	Potencia	Lúmenes	Luz	Color	Embalaje
200210010	4W	500Lm	3000K	<input type="radio"/> Blanco	20
200210011	4W	500Lm	6000K	<input type="radio"/> Blanco	20
200210012	4W	500Lm	3000K	<input checked="" type="radio"/> Negro	20
200210013	4W	500Lm	6000K	<input checked="" type="radio"/> Negro	20



Siltala
APLIQUE

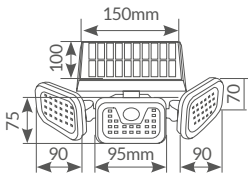

Aplique solar LED
orientable con sensor

- 6500K
- 270°
- 10.000
- ≥80Ra
- 20.000h
- IP44

Material: **ABS + PC, anti UV**. 3 modos. Sensor de **movimiento** y **crepuscular**. Uso exterior.
Ángulo de detección: 120°. **Radio de detección:** 5-8M. Batería Li-ion 18650 / 3.7V 1600mAh(reemplazables).
Tiempo de carga: 8h. **Protección contra rayos UV**. Encendido a los <30lux.
Autonomía: 3-4h. (Modo A) / 6-8h. (Modo B), 5-6h. (Modo C).

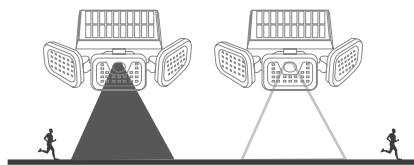

MODO A

Movimiento. 100% cuando detecta movimiento durante 30 segundos.

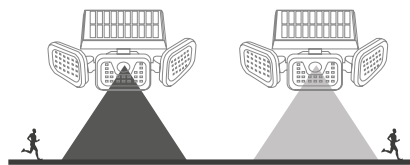

MODO B

Movimiento. 100% cuando detecta movimiento durante 30 segundos, luego cambia al 30%.

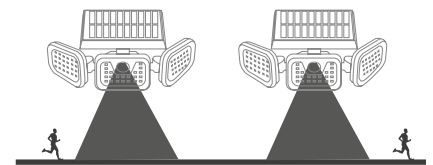

MODO C

ON. Siempre encendida al 50%. El sensor de movimiento está inactivo.

Referencia	Potencia	Lúmenes	Luz	Color	Embalaje
200210020	5.92W	350Lm	6500K	Negro	12

Exterior Solar

Meloy

APLIQUE

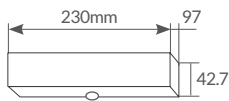

Exterior Solar

Aplique solar LED con sensor crepuscular y movimiento

Material: **ABS + PC**. 2 modos. Sensor de **movimiento** y **crepuscular**. Uso exterior.
Ángulo de detección: 120°. **Área de detección:** ≤6M. Batería Li-ion 18650 / 3000mAh / 3.7V (reemplazables).
Tiempo de carga: 8-10h. **Protección contra rayos UV.**



Imagen 1



Imagen 2

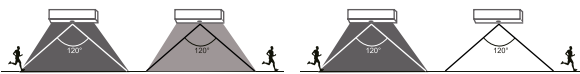

Imagen 3

MODO A. Modo sensor. Cuando la energía de la batería es superior al 30%, el aplique se enciende automáticamente por la noche y cambia al 100% cuando detecta movimiento en el rango <6M, luego se atenúa al 5% transcurridos 20 segundos sin movimiento. (Imagen 1).

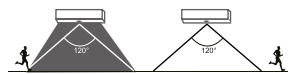
Cuando la energía de la batería es inferior al 30%, el aplique se enciende automáticamente por la noche y se enciende al 100% cuando detecta movimiento en un rango de <6M y luego se apaga después de 20 segundos sin movimiento. (Imagen 2).

MODO B. Mantener el modo de iluminación. El aplique se enciende automáticamente por la noche y se mantiene al 50%, después de 5 horas o cuando la energía de la batería sea inferior al 30%, el aplique cambia al modo de ahorro de energía.

El aplique cambia automáticamente al 100% cuando detecta movimiento en el rango <6M, luego se apaga transcurridos 20 segundos sin movimiento. (Imagen 3).

Referencia	Potencia	Lúmenes	Luz	Embalaje
200210008	6W	800Lm	● 4000K	10
200210009	6W	800Lm	● 6500K	10

Ganda

APLIQUE



3W 5W 8W



CHARGING
USB

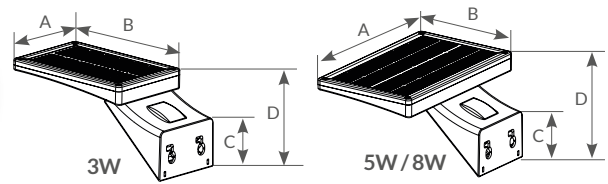
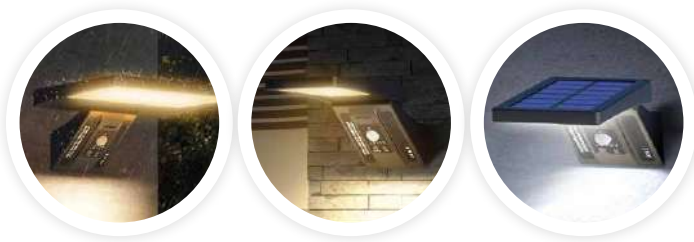

Aplicador solar LED con sensor crepuscular y movimiento

- 140°x90°
- 10.000
- ≥80Ra
- 35.000h
- IP65

Material: **ABS + PC + AL**. 4 modos. Sensor de **movimiento** y **crepuscular**. **Temperatura regulable**: 3000K-4200K-6000K.
Ángulo de detección: 100-120°. **Área de detección**: ≤10M. Batería Li-ion 18650 / 1500mAh (3W) / 2600mAh (5W) / 5200mAh (8W) 3.7V (reemplazables). **Tiempo de carga**: solar 6-8h. / USB 4-6h. Altura instalación: <4M. Autonomía: 24-36h (Modo A), 12-24h. (Modo B y C), 5h. (Modo emergencia) **Protección contra rayos UV**. Uso exterior.



MODO A. El aplicador se enciende automáticamente por la noche y se enciende al 100% cuando detecta movimiento en un rango de <10M y luego se apaga después de 15 segundos sin detectar movimiento.



MODO B. El aplicador se enciende automáticamente por la noche y se enciende al 100% cuando detecta movimiento en un rango de <10M y luego se atenúa al transcurrir 15 segundos sin detectar movimiento.



MODO C. El aplicador se encenderá automáticamente por la noche con luz tenue. (sensor de movimiento apagado).



MODO EMERGENCIA. Presionar el botón ON/OFF durante 5 segundos, y el aplicador estará siempre encendido hasta que la batería se descargue. Presionar el botón 5 segundos nuevamente para volver al modo normal.

Referencia	Potencia	Lúmenes	Luz	Dimensión (AxBxC)	Panel	Embalaje
200210017	3W	360Lm	3000K-4200K-6000K	102x213x98mm	83x138mm	40
200210018	5W	600Lm	3000K-4200K-6000K	207x183x98mm	187x108mm	32
200210019	8W	1000Lm	3000K-4200K-6000K	240x215x98mm	220x140mm	20



Tombua

APLIQUE

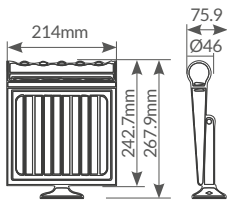

Exterior Solar

Aplique solar LED con sensor crepuscular y movimiento

Material: **ABS + PC**. 2 modos. Sensor de **movimiento** y **crepuscular**. Uso exterior.

Ángulo de detección: 120°. **Radio de detección:** 8M. Batería Li-ion 18650 / 4000mAh / 3.7V (reemplazables).

Encendido a los <30lux. Apagado a los >30lux. **Autonomía: 5h.** (Luz 100%) / **3-5 noches** (Modo A), **2-3 noches.** (Modo B). **Tiempo de carga:** 5- 6h. **Protección contra rayos UV.** Botón On/Off.

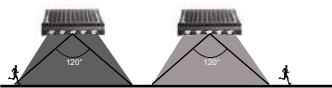

MODO 1
A. BATERÍA >30%. Se enciende al 100% al detectar presencia, sino detecta presencia, brillo al 5%.



B. BATERÍA <30%. Se enciende al 100% al detectar presencia, sino detecta presencia, estará apagado.

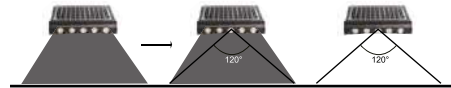

MODO 2
Se enciende al 100%, después de 5 horas o cuando la batería está <30% cambia a modo ahorro de batería.

Referencia	Potencia	Lúmenes	Luz	Dimensión (AxBxC)	Embalaje
200210014	8W	950Lm	● 4000K	193.7x52.7x492.5mm	20
200210015	8W	950Lm	● 6500K	193.7x52.7x492.5mm	20

Bajura

FAROLA

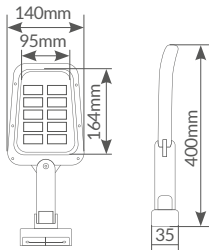

-  6500K
-  120°
-  50.000
-  ≥70Ra
-  8.000h
-  IP54

Exterior Solar

Farola solar LED con sensor crepuscular y movimiento

Material: **ABS + PC**. 2 modos. Sensor de **movimiento** y **crepuscular**. Uso exterior.
Ángulo de detección: 120°. **Área de detección:** 6-8M. Batería Li-ion 18650 / 3000mAh / 3.7V (reemplazables).
Tiempo de carga: solar 8h. **Protección contra rayos UV.**

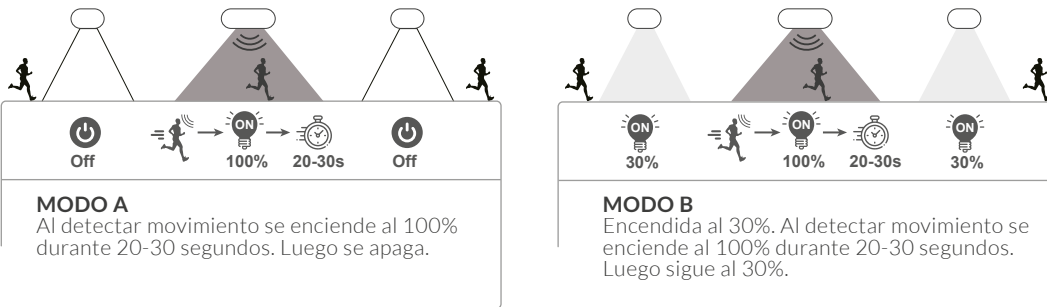

Referencia	Potencia	Lúmenes	Luz	Dimensión (AxBxC)	Embalaje
200210025	14W	500Lm	● 6500K	140x35x400mm	20

Ornes
FAROLA



Exterior Solar

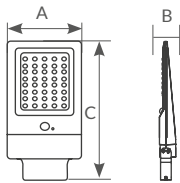

- 4000K
- 6000K
- 140°x70°
- 5.000
- ≥80Ra
- 30.000h
- IP65

Farola solar LED con sensor crepuscular y movimiento

Material: **ABS + PC**. 2 modos. Sensor de **movimiento** y **crepuscular**. Uso exterior.
Ángulo de detección: 120°. **Área de detección:** 3-8M. Batería Li-ion 18650 / 6000mAh / 3.7V (reemplazables).
Tiempo de carga: 6h. **Protección contra rayos UV.**

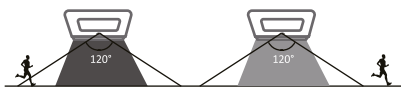

MODO 1
Las primeras 5 horas de iluminación: se enciende automáticamente al 100% cuando detecta movimiento en el rango de <8M y luego cambia a luz tenue cuando transcurren 20 segundos sin movimiento.

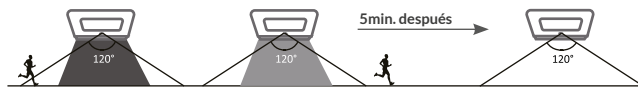

MODO 2
Después de 5h de iluminación o cuando la capacidad de la batería es inferior al 30%: se enciende automáticamente al 100% cuando detecta movimiento en el rango de <8M y luego cambia a luz tenue cuando transcurren 20 segundos sin movimiento, luego se apaga después de 5 minutos.

Referencia	Potencia	Lúmenes	Luz	Dimensión (AxBxC)	Embalaje
201635001	8W	850Lm	4000K	193.7x52.7x492.5mm	10
201635002	8W	850Lm	6000K	193.7x52.7x492.5mm	10
201635003	15W	1600Lm	4000K	231.9x58x492.5mm	10
201635004	15W	1600Lm	6000K	231.9x58x492.5mm	10

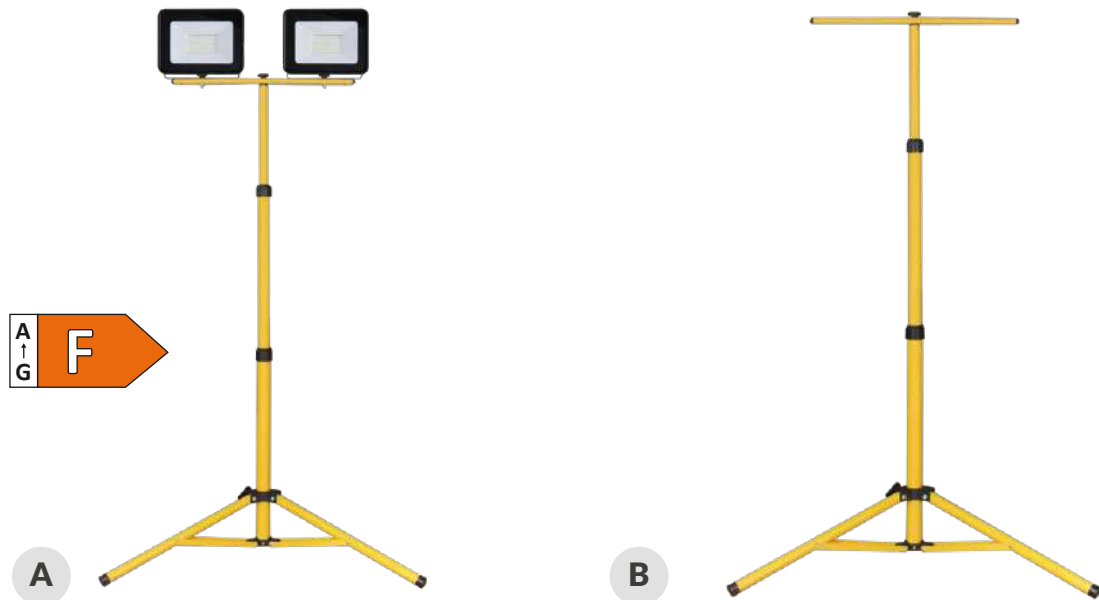

6500K



120°



100.000



≥80Ra



25.000h.



IP65



220-240V



50/60Hz

Doble foco 60W LED + trípode

Con **trípode telescópico**. Material: **aluminio**. Color: amarillo. Fácil conexión. Longitud cable: **3M**. Sección cable: 3x1.0mm². **IK08**.

Referencia	Artículo	Potencia	Lúmenes	Luz	Dimensión (AxBxC)	Embalaje
202605005	A	2 x 30W	2 x 2690lm	● 6500K	155x24x125mm	50

Trípode telescópico



IP44

Trípode telescópico ideal para colocar 2 focos LED o halógenos. Plegado compacto 160x640. Incluye caja de conexión de cables. Elige tu foco en las siguientes páginas.

Referencia	Artículo	Para	Altura	Dimensión (AxBxC)	Embalaje
202605000	B	2 focos	1.55M (Máx.)	770x1550mm	30

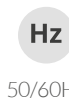
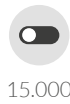
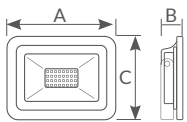
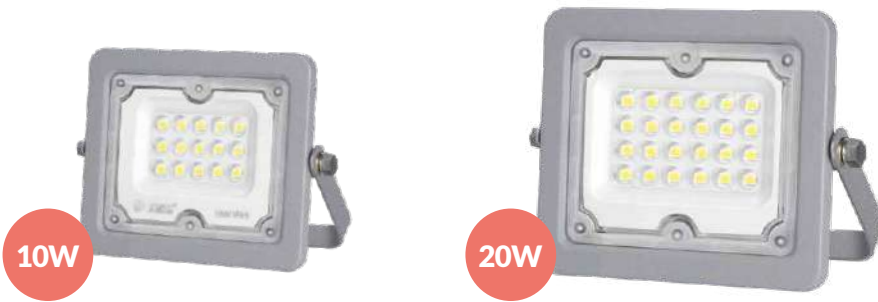

Proyector aluminio LED

Material: **aluminio**. Color: **gris**. Con cable **H05RN-F** 3G 0.75mm². Longitud cable: 30cm. Uso exterior. **IK08**.

Referencia	Potencia	Lúmenes útiles (90°)	Lúmenes nominales (360°)	Luz	Dimensión (AxBxC)	Embalaje
202600058	10W	840Lm	900Lm	● 6500K	107.3x15.5x84mm	50
202600059	20W	1800Lm	2000Lm	● 6500K	121x18.5x101.1mm	20
202600060	30W	2600Lm	3000Lm	● 6500K	167x18.5x127.6mm	20
202600061	50W	4800Lm	5000Lm	● 6500K	213x18.5x163mm	20
202600063	150W	14.300Lm	15.000Lm	● 6500K	331x25.8x230mm	5



10W / 20W / 30W



50W

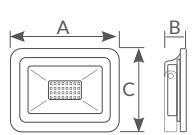

- 3000K
- 4000K
- 6500K
- 90°
- 15.000
- ≥80Ra
- 30.000h.
- IP65
- 220-240V
- 50/60Hz

Proyector aluminio LED

Material: **aluminio**. Color: **negro**. Con cable **H05RN-F** 3G 0.75mm². Longitud cable: 30cm. Uso exterior. **IK08**.

Referencia	Potencia	Lúmenes útiles (90°)	Lúmenes nominales (360°)	Luz	Dimensión (AxBxC)	Embalaje
202600077	10W	840Lm	900Lm	4000K	107.3x15.5x84mm	50
202600078	10W	840Lm	900Lm	6500K	107.3x15.5x84mm	50
202600079	20W	1800Lm	2000Lm	4000K	121x18.5x101.1mm	20
202600094	30W	2600Lm	3000Lm	3000K	167x18.5x127.6mm	20
202600081	30W	2600Lm	3000Lm	4000K	167x18.5x127.6mm	20
202600082	30W	2600Lm	3000Lm	6500K	167x18.5x127.6mm	20
202600083	50W	4800Lm	5000Lm	3000K	213x18.5x163mm	20
202600085	50W	4800Lm	5000Lm	6500K	213x18.5x163mm	20

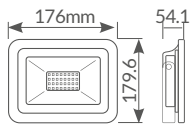

4000K



6500K



90°



15.000



≥80Ra



30.000h.



IP65



220-240V



50/60Hz

Proyector aluminio LED con sensor

Material: **aluminio**. Uso exterior. Con **sensor PIR**. **Ángulo de detección:** 120°.

Tiempo encendido: de 10±3seg. hasta 7±2min. (reg.). **Distancia máx. detección:** 8M. **Altura instalación:** 1.8-2.5M.

Luz ambiental: 3-2000lux (reg.). **Detec. velocidad mov.:** 0.6-1.5M/s. Con cable **H05RN-F 3G 0.75mm²**.

Longitud cable: 30cm. **IK08**.

Referencia	Potencia	Lúmenes útiles (90°)	Lúmenes nominales (360°)	Luz	Color	Embalaje
202610009	20W	1800Lm	2000Lm	● 4000K	● Negro	20
202610010	20W	1800Lm	2000Lm	● 6500K	● Negro	20

Belinta

SERIE

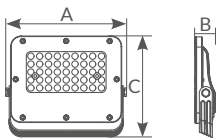

Proyector aluminio LED

Material: **aluminio + PC**. Color: **negro**. Con cable **H05RN-F 3G 0.75mm²**. Longitud cable: 30cm. Uso exterior. **IK07. PF >0.9**.

Referencia	Potencia	Lúmenes útiles (90°)	Lúmenes nominales (360°)	Luz	Dimensión (AxBxC)	Embalaje
202600118	30W	2600Lm	3000Lm	● 3000K	167x28x140mm	20
202600119	30W	2600Lm	3000Lm	● 4000K	167x28x140mm	20
202600120	30W	2600Lm	3000Lm	● 6500K	167x28x140mm	20
202600121	50W	4800Lm	5000Lm	● 3000K	202x31x166mm	20
202600122	50W	4800Lm	5000Lm	● 4000K	202x31x166mm	20
202600123	50W	4800Lm	5000Lm	● 6500K	202x31x166mm	20

Belinta

SERIE



100W



150W



200W

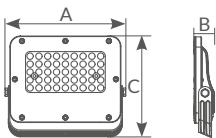

- 4000K
- 6500K
- 90°
- 15.000
- ≥80Ra
- 30.000h.
- IP65
- 220-240V
- 50/60Hz

Proyector aluminio LED

Material: **aluminio + PC**. Color: **negro**. Con cable **H05RN-F 3G 1mm²**. Longitud cable: 30cm. Uso exterior. **IK07. PF >0.9**.

Referencia	Potencia	Lúmenes útiles (90°)	Lúmenes nominales (360°)	Luz	Dimensión (AxBxC)	Embalaje
202600124	100W	9600Lm	10.000Lm	4000K	262x34x221mm	20
202600125	100W	9600Lm	10.000Lm	6500K	262x34x221mm	20
202600126	150W	14.300Lm	15.000Lm	4000K	300x38x256mm	10
202600127	150W	14.300Lm	15.000Lm	6500K	300x38x256mm	10
202600128	200W	20.000Lm	22.000Lm	4000K	345x38x283mm	10
202600129	200W	20.000Lm	22.000Lm	6500K	345x38x283mm	10

Belinta

SERIE



30W



50W

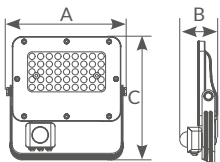

Proyector aluminio LED

Material: aluminio + PC.. Con sensor PIR. Ángulo de detección: 120°.

Tiempo encendido: de 10±3seg. hasta 7±2min. (reg.). Distancia máx. detección: 8M. Altura instalación: 1.8-2.5M.

Luz ambiental: 3-2000lux (reg.). Detec. velocidad mov.: 0.6-1.5M/s. Con cable H05RN-F 3G 0.75mm².

Longitud cable: 30cm. Uso exterior. IK07. PF >0.9.

Referencia	Potencia	Lúmenes útiles (90°)	Lúmenes nominales (360°)	Luz	Dimensión (AxBxC)	Embalaje
202610014	30W	2600Lm	3000Lm	● 4000K	170x54x175mm	20
202610015	30W	2600Lm	3000Lm	● 6500K	170x54x175mm	20
202610016	50W	4800Lm	5000Lm	● 4000K	203x54x200mm	20
202610017	50W	4800Lm	5000Lm	● 6500K	203x54x200mm	20

Sulevai

SERIE



Exterior Proyectores



Antideslumbramiento

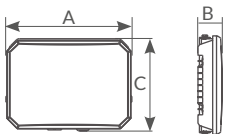

4000K



6500K



120°



15.000



≥80Ra



35.000h.



IP65



110-265V



50/60Hz

Proyector aluminio LED

Material: aluminio + plástico. Difusor antideslumbramiento. Color: negro.
Con cable H05RN-F 3x0.75mm². Longitud cable: 30cm. Uso exterior. IK07.

Referencia	Potencia	Lúmenes	Luz	Dimensión (AxBxC)	Embalaje
202600114	30W	3600Lm	● 4000K	140.5x33.2x100mm	20
202600115	30W	3600Lm	● 6500K	140.5x33.2x100mm	20
202600116	50W	6000Lm	● 4000K	180.2x37.2x135.2mm	5
202600117	50W	6000Lm	● 6500K	180.2x37.2x135.2mm	5

Liwale
SERIE

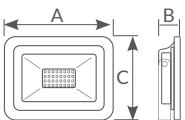

4000K

5700K

110°

20.000

≥70Ra

30.000h.

IP65

100-240V

50/60Hz

Proyector aluminio LED

Material: **aluminio + cristal**. Cristal **antideslumbramiento**. Color: **negro**.
Con cable **H05RN-F 3x1.0mm²**. Longitud cable: 1M. Uso exterior. **PF>0.9. IK06**.

Referencia	Potencia	Lúmenes útiles (110°)	Lúmenes nominales (360°)	Luz	Dimensión (AxBxC)	Embalaje
202600106	50W	5740Lm	6750Lm	● 4000K	183.5x34x169mm	10
202600107	50W	5740Lm	6750Lm	● 5700K	183.5x34x169mm	10
202600108	100W	11.480Lm	13.500Lm	● 4000K	253.5x40x242.5mm	4
202600109	100W	11.480Lm	13.500Lm	● 5700K	253.5x40x242.5mm	4
202600110	150W	17.220 Lm	20.250 Lm	● 4000K	328.5x43x295mm	4
202600111	150W	17.220 Lm	20.250 Lm	● 5700K	328.5x43x295mm	4
202600112	200W	22.960Lm	27.000Lm	● 4000K	402.5x44x349.5mm	2
202600113	200W	22.960Lm	27.000Lm	● 5700K	402.5x44x349.5mm	2

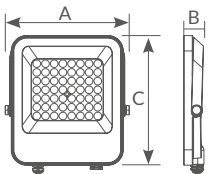

Proyector aluminio **ultrafino** LED

Material: **aluminio + PC**. Color: **blanco**. Longitud cable: 300mm. Tipo cable: H05RN-F3G 0.75mm². Uso exterior.

Referencia	Potencia	Lúmenes útiles (90°)	Lúmenes nominales (360°)	Luz	Dimensión (AxBxC)	Embalaje
202600092	30W	2850Lm	3300Lm	● 3000K	178x29x197.2mm	20
202600065	30W	2850Lm	3300Lm	● 4000K	178x29x197.2mm	20
202600066	30W	2850Lm	3300Lm	● 6500K	178x29x197.2mm	20
202600093	50W	4700Lm	5500Lm	● 3000K	204.5x29x227.9mm	20
202600069	50W	4700Lm	5500Lm	● 4000K	204.5x29x227.9mm	20
202600070	50W	4700Lm	5500Lm	● 6500K	204.5x29x227.9mm	20

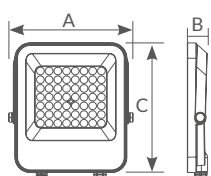

- 4000K
- 6500K
- 90°
- ≥15.000
- ≥80Ra
- 30.000h.
- IP65
- 220-240V
- 50Hz

Proyector aluminio **ultrafino** LED

Material: **aluminio + PC**. Color: **gris**. Longitud cable: 300mm. Tipo cable: H05RN-F3G 0.75mm². Uso exterior.

Referencia	Potencia	Lúmenes útiles (90°)	Lúmenes nominales (360°)	Luz	Dimensión (AxBxC)	Embalaje
202600067	30W	2850Lm	3300Lm	4000K	178x29x197mm	20
202600068	30W	2850Lm	3300Lm	6500K	178x29x197mm	20
202600071	50W	4700Lm	5500Lm	4000K	204.5x29x227.9mm	20
202600072	50W	4700Lm	5500Lm	6500K	204.5x29x227.9mm	20
202600074	100W	9500Lm	11.000Lm	6500K	272x32x309mm	10
202600075	150W	14.200Lm	16.500Lm	6500K	253x31x284.3mm	5
202600076	200W	18.900Lm	22000Lm	6500K	297x32.5x338mm	5

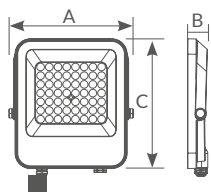

- 6500K
- 90°
- ≥15.000
- ≥80Ra
- 30.000h.
- IP65
- 220-240V
- 50Hz

Proyector aluminio ultrafino LED con sensor

Material: **aluminio + PC**. Color: **gris**. Uso exterior. Con **sensor PIR**. **Ángulo de detección:** 120°. **Tiempo encendido:** 7±2min.(reg.). **Distancia máx. detección:** 10M. **Altura instalación:** 1.8-2.5M. **Luz ambiental:** 3-2000lux (reg.). **Detec. velocidad mov.:** 0.6-1.5M/s. Cable H05RN-F 3Gx1mm² incluido.

Referencia	Potencia	Lúmenes útiles (90°)	Lúmenes nominales (360°)	Luz	Dimensión (AxBxC)	Embalaje
202610007	30W	2850Lm	3300Lm	● 6500K	160x29x291.2mm	20
202610008	50W	4700Lm	5500Lm	● 6500K	187.1x29x322mm	20

Tandur

SERIE

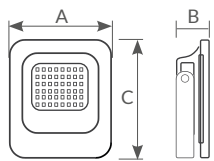

6500K



120°



15.000



≥80Ra



30.000h.



IP65



220-240V



50/60Hz

Proyector aluminio LED

Material: **aluminio**. Color: **negro**. Con cable **H05RN-F 3G 0.75mm²**. Longitud cable: 30cm. Uso exterior. **IK08**.

Referencia	Potencia	Lúmenes	Luz	Dimensión (AxBxC)	Embalaje
202600095	10W	1000Lm	● 6500K	111x22.5x97.5mm	50
202600096	20W	2000Lm	● 6500K	121x23x131mm	20
202600097	30W	3000Lm	● 6500K	136x32x170mm	20
202600098	50W	5000Lm	● 6500K	183x32x205mm	20



Tandur

SERIE

Exterior Proyectores

100W



150W



200W

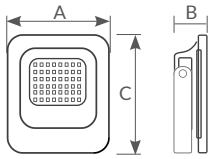

- 6500K
- 90°
- 15.000
- ≥80Ra
- 30.000h.
- IP65
- 220-240V
- 50/60Hz

Proyector aluminio LED

Material: **aluminio**. Color: **negro**. Con cable **H05RN-F** 3x1.0mm². Longitud cable: 30cm. Uso exterior. **IK08**.

Referencia	Potencia	Lúmenes	Luz	Dimensión (AxBxC)	Embalaje
202600099	100W	9400Lm	● 6500K	217x33x234mm	10
202600100	150W	15.000Lm	● 6500K	277x33x239mm	5
202600101	200W	18.500Lm	● 6500K	284x33x318mm	5

Mondir

PROYECTOR SENSOR



Exterior Proyectores

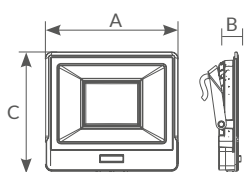

6500K



110°



20.000



≥80Ra



25.000h.



IP65



220-240V



50/60Hz

Proyector LED con sensor

Material: aluminio. Color: negro. Con sensor PIR. Ángulo de detección: 120°.

Tiempo encendido: 10 segundos hasta 7min.(reg.). Distancia máx. detección: 10M. Altura instalación: 1.8-2.5M.

Luz ambiental: <10-2000lux (reg.). Detec. velocidad mov.: 0.6-1.5M/s. Cable H05RN-F 3Gx1mm² 300mm incluido. IK06.

Referencia	Potencia	Lúmenes útiles (120°)	Lúmenes nominales (360°)	Luz	Dimensión (AxBxC)	Embalaje
202610011	10W	735Lm	830Lm	● 6500K	113x55x133mm	40
202610012	30W	2510Lm	2950Lm	● 6500K	143x56x177mm	20
202610013	50W	4280Lm	5200Lm	● 6500K	178x57x195mm	20

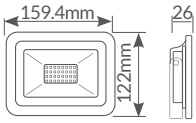

- RGB
- 120°
- ≥15.000
- ≥80Ra
- 35.000h.
- IP65
- 185-265V
- 50Hz

Proyector aluminio LED RGB

Material: **aluminio**. Color: **gris**. Uso exterior.

Referencia	Potencia	Lúmenes	Luz	Embalaje
202600043	30W	3300Lm	RGB	20

Kintore PROYECTOR

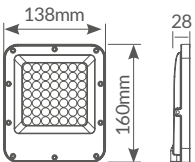

- RGB
- 90°
- 15.000
- ≥80Ra
- 30.000h.
- IP65
- 220-240V
- 50/60Hz

Proyector aluminio LED RGB

Material: **aluminio + PC**. Color: **negro**. Intensidad regulable. Con memoria del último estado de color. Con cable **H05RN-F 3x1mm²**. Longitud cable: 30cm. Uso exterior.

Referencia	Potencia	Luz	Cambios de color	Embalaje
202600130	30W	RGB	Hasta 16 cambios	20

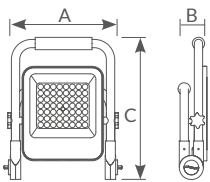

- 
6500K
- 
90°
- 
≥15.000
- 
≥80Ra
- 
30.000h.
- 
IP65
- 
220-240V
- 
50Hz

Proyector aluminio LED + soporte móvil

Material: **aluminio**. Color: **gris**. Soporte **abatible**. Cable H05RN-F3G 1mm². Cable: **1.5M**. Uso exterior.

Referencia	Potencia	Lúmenes	Luz	Dimensión (AxBxC)	Embalaje
202605007	30W	2850Lm	● 6500K	217.5x57x280mm	10
202605008	50W	4700Lm	● 6500K	244.5x59x324mm	5

Sampaya

PROYECTOR

Exterior Proyectores



Modo de emergencia

5W ≈ 30W

8W ≈ 50W



Abatible

CHARGING
USB

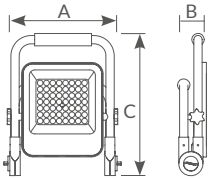

6500K



90°



≥80Ra



35.000h.



IP65

Proyector LED con batería

Material: **aluminio**. Color: **amarillo**.

Tiempo de carga: 5-6 horas. **4 modos**: alta, media, baja y emergencia.

Cable de carga **USB 1M** (incluido). Batería Panasonic. DC3.7V. Uso exterior. **IK08**.

Referencia	Potencia	Lúmenes	Luz	Batería	Dimensión (AxBxC)	Embalaje
202605001	5W ≈ 30W	1022Lm	● 6500K	6000mAh	160.6x29x186mm	1
202605002	8W ≈ 50W	1435Lm	● 6500K	12.000mAh	187.1x29x217mm	1
202620002	Batería recambio para proyector 202605002					

Battali

PROYECTOR



10W

20W

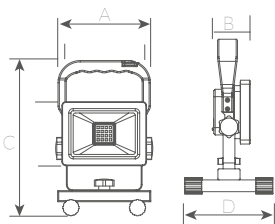

6500K



110°



≥80Ra



20.000h.



IP54

Proyector LED con batería

Material: **acero + plástico**. Color: **amarillo y negro**.

Tiempo de carga: 2-4 horas. **2 modos:** alta y media intensidad

Cable de carga USB 1M (incluido). Batería Li-Ion 18650. DC5V. Uso exterior. **IK08**.

Referencia	Potencia	Lúmenes útiles (90°)	Lúmenes nominales (360°)	Luz	Batería	Dimensión (AxBxCxD)	Embalaje
202605009	10W	1000Lm	1100Lm	● 6500K	2.200mAh	132x52x210x120mm	20
202605010	20W	2000Lm	2200Lm	● 6500K	4.400mAh	132x66x210x120mm	20



Decoración de interior

Tipo portátil o para colgar



Estaca para jardín

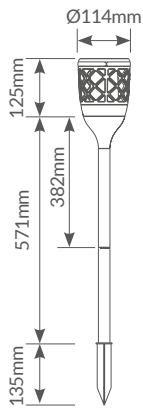

Incluye: farolillo, base y estaca con dos niveles de altura.



Carga solar



Carga por USB



Estaca LED efecto fuego solar recargable & USB

Material: **ABS + PC, anti UV**. Autonomía: modo A 3 noches / modo B 4 horas. Carga **micro USB**: 1A / 5V. Panel solar que funciona con una pila Li-Ion 1865/3.7V/1200mAh. **Tiempo de carga solar**: 12h. **Tiempo de carga USB**: 2h. Incluye: farolillo, base, estaca con 2 niveles de altura. **IP65**.

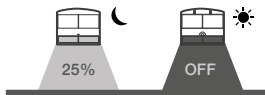

MODO A / EXTERIOR

Se enciende automáticamente al anochecer (<30lux), se mantiene al 25%, y se apaga al amanecer (>150lux). Este modo se aplicará cuando el producto esté en exteriores.



MODO B / EXTERIOR E INTERIOR

Se enciende automáticamente al anochecer (<30lux), se mantiene al 100%, y se apaga al amanecer (>400lux). Este modo se aplicará cuando el producto esté en interiores o exteriores.

Referencia	Potencia	Luz	Embalaje
201210000	2W	● 1500K	24

Bouquet

ESTACA JARDÍN

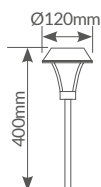

Estaca jardín solar LED



Display 12 unidades.

Material: **plástico**. Pila recargable AA 1.2V / 100mAh Ni-MH. **Tiempo de carga:** 6-8h.

Referencia	Panel solar	Luz	Color	Embalaje
000705365	40x40mm	● 8000-8500K	● Negro	12

Palakot

ESTACA JARDÍN

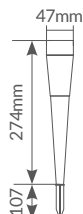

Estaca jardín solar LED



Display 24 unidades.

Material: **plástico**. Pila recargable AAA 1.2V / 100mAh Ni-MH. **Tiempo de carga:** 6-8h.

Referencia	Panel solar	Luz	Color	Embalaje
201210019	30x30mm	● 6300-6900K	● Negro	24

Banki

ESTACA JARDÍN

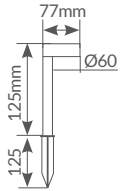

IP44

Estaca jardín solar LED luz indirecta

Display 12 unidades.

Material: plástico. Pila recargable AAA 1.2V / 100mAh Ni-MH. Tiempo de carga: 6-8h.

Luz indirecta hacia el suelo. Ideal para iluminar caminos, pasos,...

Referencia	Panel solar	Luz	Color	Embalaje
201210017	35x35mm	● 2800-3200K	● Negro	12

Bukka

ESTACA JARDÍN

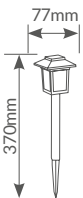

IP44

Estaca jardín solar LED

Display 12 unidades.

Material: plástico. Efecto llama. Pila recargable AAA 1.2V / 200mAh Ni-MH. Tiempo de carga: 6-8h.

Referencia	Panel solar	Luz	Color	Embalaje
201210007	34x34mm	● 1600K	● Negro	12

Tuni

ESTACA JARDÍN

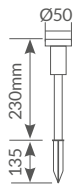

IP44

Estaca jardín solar LED

Display 24 unidades.

Material: **plástico**. Textura efecto piedra. Pila recargable AAA 1.2V / 100mAh Ni-MH. Tiempo de carga: 6-8h.

Referencia	Panel solar	Luz	Color	Embalaje
201210015	30x30mm	● 6000-8500K	● Gris	24

Suna

ESTACA JARDÍN

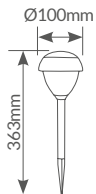

IP44

Estaca jardín solar LED

Display 12 unidades.

Material: **plástico + acero inox**. Pila recargable AAA 1.2V / 300mAh Ni-MH. Tiempo de carga: 6-8h.

Referencia	Panel solar	Luz	Color	Embalaje
201210006	34x34mm	● 10.000K	● Níquel Satín	12

Righa

ESTACA JARDÍN

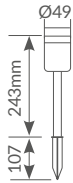

Estaca jardín solar LED

Display 24 unidades.

Material: **plástico + acero inox**. Pila recargable botón 1.2V / 40mAh Ni-MH. **Tiempo de carga:** 6-8h.

Referencia	Panel solar	Luz	Color	Embalaje
201210018	25x25mm	● 2700-3300K	● Níquel Satín	24

Antorcha

ESTACA JARDÍN

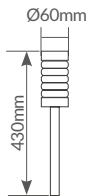

Estaca jardín solar LED

Display 12 unidades.

Material: **crystal + acero inox**. Pila recargable AAA 1.2V / 100mAh Ni-MH. **Tiempo de carga:** 6-8h.

Referencia	Panel solar	Luz	Color	Embalaje
000705366	34x34mm	● 6000-6500K	● Níquel Satín	12

Nuwara

ESTACA JARDÍN

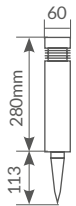

Estaca jardín solar LED

Display 12 unidades.

Material: **plástico**. Pila recargable AA 1.2V / 200mAh Ni-MH. **Tiempo de carga:** 6-8h.

Referencia	Panel solar	Luz	Color	Embalaje
201210020	39x39mm	● 6000-6500K	● Negro	12

Niali

ESTACA JARDÍN

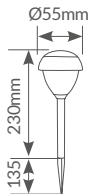

Estaca jardín solar LED

Display 24 unidades.

Material: **plástico + acero inox**. Efecto llama. Pila recargable AAA 1.2V / 200mAh Ni-MH. **Tiempo de carga:** 6-8h.

Referencia	Panel solar	Luz	Color	Embalaje
201210014	30x30mm	● 1600-1800K	● Níquel Satín	24



Kodala

ESTACA JARDÍN

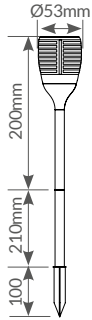

IP44

Estaca jardín solar LED

Display 12 unidades.

Material: **plástico. Efecto llama.** Pila recargable 2/3AAA 1.2V / 200mAh Ni-MH. **Tiempo de carga:** 6-8h.

Referencia	Panel solar	Luz	Color	Embalaje
201210016	30x30mm	● 1600-1800K	● Negro	12

Arthar

ESTACA JARDÍN

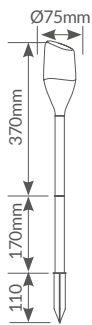

IP44

Estaca jardín solar LED

Material: **plástico. Efecto llama.** Pila recargable AA 1.2V / 600mAh Ni-MH. **Tiempo de carga:** 6-8h.

Referencia	Panel solar	Luz	Color	Embalaje
201210021	Ø55mm	● 1600-1800K	● Negro	12



Estaca jardín

Color: **negro**. Uso exterior. Sin cable.

Referencia	Artículo	Potencia	Para	Dimensión	Embalaje
000700452	A	Máx. 150W	PAR38 (x1)	Ø75x160x285mm	20
000700453	B	Máx. 2 x 150W	PAR38 (x2)	Ø75x165x325mm	15

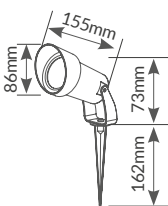

Estaca jardín

Material: **ABS + PC**. Cable: 300mm. Sección: 2x0.75mm. Bombilla no incluida. Color: **negro**. Uso exterior. **IK08**.

Referencia	Potencia	Casquillo	Embalaje
201200000	Máx. 7W Incandescencia Máx. 12W Bajo consumo / LED	GU10	20
201295001	Cristal recambio de estaca jardín 201200000		

Exterior Estacas

Silute

ESTACA JARDÍN

Tres tonalidades de luz disponibles



Luz día 4000K



Luz fría 6500K



Luz Verde



Piezas modulares para varias alturas

Instalación en pared

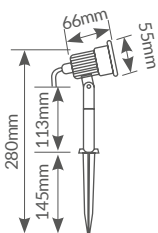

4000K



6500K



VERDE



38°



100.000



≥80Ra



20.000h.



IP65



220-240V



50/60Hz

Estaca jardín LED

Material: nylon + PC. Instalación en jardín con estaca o en pared con tornillos. Tornillos de montaje incluidos. IK06.

Referencia	Potencia	Lúmenes	Luz	Embalaje
201200001	5W	410Lm	4000K	50
201200002	5W	410Lm	6500K	50
201200003	5W	-	Verde	50



Darka

ESTACA JARDÍN

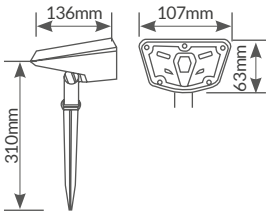

Instalación en pared
con tornillos



Colocación en jardín
con estaca



3300K



IP67

Estaca jardín solar LED regulable

Material: **ABS + PC. 2 modos de intensidad.** Pila recargable de litio 18650 / 2000mAh Ni-MH.

Autonomía: 6h. (máxima intensidad), 12h. (baja intensidad). **Tiempo de carga:** 6-8h. Panel solar: 115x82mm.

Instalación en **jardín con estaca** o **en pared con tornillos**. Tornillos de montaje incluidos.

Referencia	Potencia	Lúmenes	Luz	Embalaje
201210004	3W	60Lm	● 3300K	24

Alezu

ESTACA JARDÍN

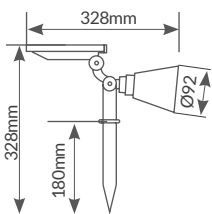

Instalación en pared con tornillos



Colocación en jardín con estaca



3300K



4200K



6500K



IPX7

Estaca jardín solar LED regulable

Material: **ABS + PC. 3 modos de intensidad.** Pila recargable de litio 18650 / 2200mAh Ni-MH.

Autonomía: 8h. (máxima intensidad), 10h. (media intensidad) 12h. (baja intensidad). **Tiempo de carga:** 6-8h.

Panel solar: 136x80mm. Instalación en **jardín con estaca** o en **pared con tornillos**. Tornillos de montaje incluidos.

Referencia	Potencia	Lúmenes	Luz	Embalaje
201210005	3W	250Lm	● 3300K	24
201210012 ★	3W	250Lm	● 4200K	24
201210013 ★	3W	250Lm	● 6500K	24

Liboi
GUIRNALDA



Interconexionables
hasta 700W

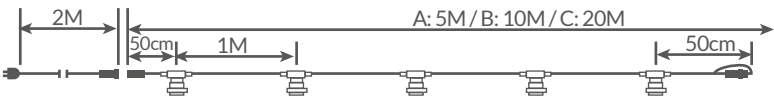

E27



IP65



220-240V



50/60Hz

Kit guirnalda decorativa

Color: **negro**. Cable redondo: H05RN-F (2x0.7mm).

Interconexionables, hasta 700W máximo. Conexión macho/hembra. Uso exterior.

Referencia	Potencia	Longitud total	Casquillo	Nº portalámparas	Embalaje
201205000	Máx. 700W	7M	E27	5	20
201205001	Máx. 700W	12M	E27	10	20
201205004 ★	Máx. 700W	22M	E27	20	20
201205002	Recambio cable enchufe 2M				
201205003	Extensible macho - hembra 50cm para guirnalda Liboi				



Helem

GUIRNALDA

Exterior Guirnalda

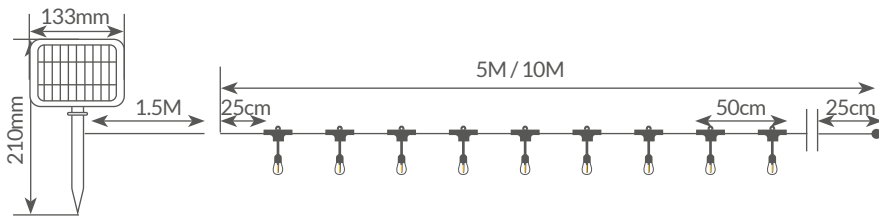

2700K



E27



IP44

Kit guirnalda **decorativa solar LED**

Color: **negro**. Con **4 niveles de intensidad**: fijo, flash lento, flash rápido y parpadeo. Panel solar: 3V.
Posibilidad de cargar mediante USB (cable no incluido). Estaca incluida. **Batería de litio** 18650 2x1800mA.
Autonomía: 12h. **Tiempo de carga**: 8-10h. Uso exterior.

Referencia	Potencia	Lúmenes	Luz	Longitud	Casquillo	Nº portalámparas	Embalaje
201210008	2W	500Lm	● 2700K	5M	E27	10	12
201210010	4W	1000Lm	● 2700K	10M	E27	20	12
201295003	Cable 1.5M para guirnalda ref. 201210008 -10						
201295002	Cable 3M para guirnalda ref. 201210008 -10						
201295004	Recambio lámpara E27 para guirnalda ref. 201210008 -10						

Tenali

GUIRNALDA

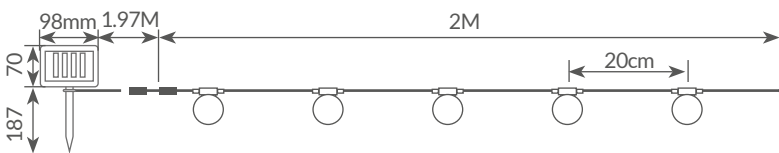

Guirnalda solar LED 2M



Modos: **On/Off. Efecto llama.** Material: **plástico.** Batería recargable **AA / 600mAh** 1.2V Ni-Mh (incluida). Panel solar 2V / 140mA. Dimensión panel solar: 80x50mm. **Autonomía:** máx. 6-8h. **Tiempo de carga:** 6-8h. Estaca incluida. Uso exterior.

Referencia	Potencia	Luz	Longitud	Nº portalámparas	Embalaje
204810003	0.06W	● 2600-2700K	2M	10	12

Exterior Guirnalda



Bagan
SERIE



*Bombilla no incluida.

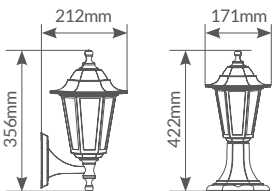

Exterior Faroles

Farol de jardín



Material: PP. Lados: 6. Uso exterior.

Referencia	Artículo	Modelo	Potencia	Casquillo	Color	Embalaje
201650002	A	Brazo reversible	Máx. 60W	E27	● Negro	6
201650003	B	Brazo reversible	Máx. 60W	E27	○ Blanco	6
201650004	C	Sobremuro	Máx. 60W	E27	● Negro	6
201650005	C	Sobremuro	Máx. 60W	E27	○ Blanco	6

Alma
SERIE



A



B



C



D

* Bombilla no incluida.

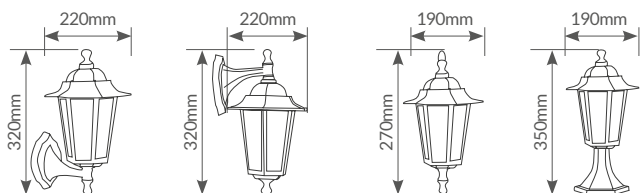

Farol de jardín



E27



IP44



220-240V



50Hz

Material: **aluminio**. Lados: 6. Uso exterior.

Referencia	Artículo	Modelo	Potencia	Casquillo	Color	Embalaje
000700070	A	Brazo abajo	Máx. 60W	E27	● Negro	6
000700071	A	Brazo abajo	Máx. 60W	E27	○ Blanco	6
000700072	B	Brazo arriba	Máx. 60W	E27	● Negro	6
000700073	B	Brazo arriba	Máx. 60W	E27	○ Blanco	6
000700074	C	Colgante	Máx. 60W	E27	● Negro	6
000700075	C	Colgante	Máx. 60W	E27	○ Blanco	6
000700076	D	Sobremuro	Máx. 60W	E27	● Negro	6
000700077	D	Sobremuro	Máx. 60W	E27	○ Blanco	6



Lenna

SERIE

Exterior Faroles



*Bombilla no incluida.

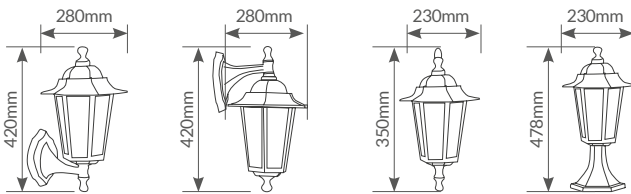

Farol de jardín



Material: **aluminio**. Lados: 6. Uso exterior.

Referencia	Artículo	Modelo	Potencia	Casquillo	Color	Embalaje
000701856	A	Brazo abajo	Máx. 60W	E27	● Negro	6
000701857	B	Brazo arriba	Máx. 60W	E27	● Negro	6
000701858	C	Colgante	Máx. 60W	E27	● Negro	6
000701859	D	Sobremuro	Máx. 60W	E27	● Negro	6

Barli
SERIE



* Bombilla no incluida.

Exterior Faroles

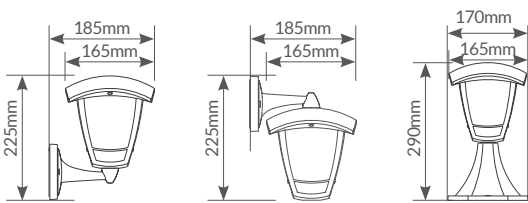

Farol de jardín



Material: **PP + PC**. Lados: 4. Uso exterior.

Referencia	Artículo	Modelo	Potencia	Casquillo	Color	Embalaje
201640001	A	Brazo abajo	Máx. 60W	E27	● Negro	12
201640002	B	Brazo arriba	Máx. 60W	E27	● Negro	12
201640003	C	Sobremuro	Máx. 60W	E27	● Negro	12



Luna SERIE

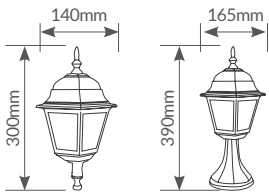

* Bombilla no incluida.

Farol de jardín



Material: **aluminio**. Lados: 4. Uso exterior.

Referencia	Artículo	Modelo	Potencia	Casquillo	Color	Embalaje
000701905	A	Colgante	Máx. 60W	E27	● Negro	6
000701906	B	Sobremuro	Máx. 60W	E27	● Negro	6

Exterior Faroles

Telina SERIE

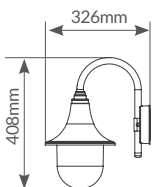

* Bombilla no incluida.

Farol de jardín brazo arriba



Material: **PP**. Tipo campana. Uso exterior.

Referencia	Modelo	Potencia	Casquillo	Color	Embalaje
201600006	Brazo arriba	Máx. 60W	E27	● Negro	6

Betka
SERIE



A



B

Brazo reversible
arriba / abajo

* Bombilla no incluida.

Exterior Faroles

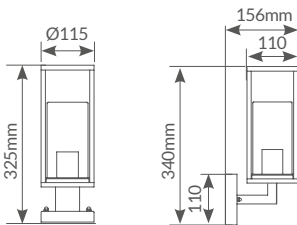

E27



IP44



220-240V



50/60Hz

Farol de jardín

Material: **aluminio + PC**. Lados: 4. Uso exterior.

Referencia	Artículo	Modelo	Potencia	Casquillo	Color	Embalaje
201645001	A	Sobremuro	Máx. 15W	E27	● Gris antracita	6
201645002	B	Brazo arriba / abajo	Máx. 15W	E27	● Gris antracita	6



Luciérnaga

SERIE

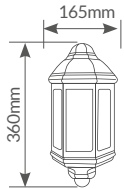

E27



IP44



220-240V



50Hz

Farol jardín de pared

Material: **aluminio**. Lados: 3. Uso exterior.

Referencia	Modelo	Potencia	Casquillo	Color	Embalaje
000701907	Pared	Máx. 60W	E27	● Negro	8

Exterior Faroles

Maro

SERIE



A



B

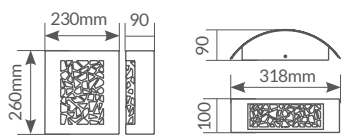

E27



IP44



220-240V



50/60Hz

Aplicador pared acero inoxidable

Material: **acero inoxidable**. Difusor: **PC**. Uso interior y exterior.

Referencia	Artículo	Potencia	Casquillo	Color	Embalaje
200200011	A	Máx. 60W	E27	● Gris antracita	12
200200012	B	Máx. 14W	E27	● Gris antracita	12

Sibe

SERIE

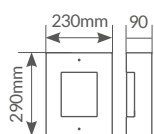
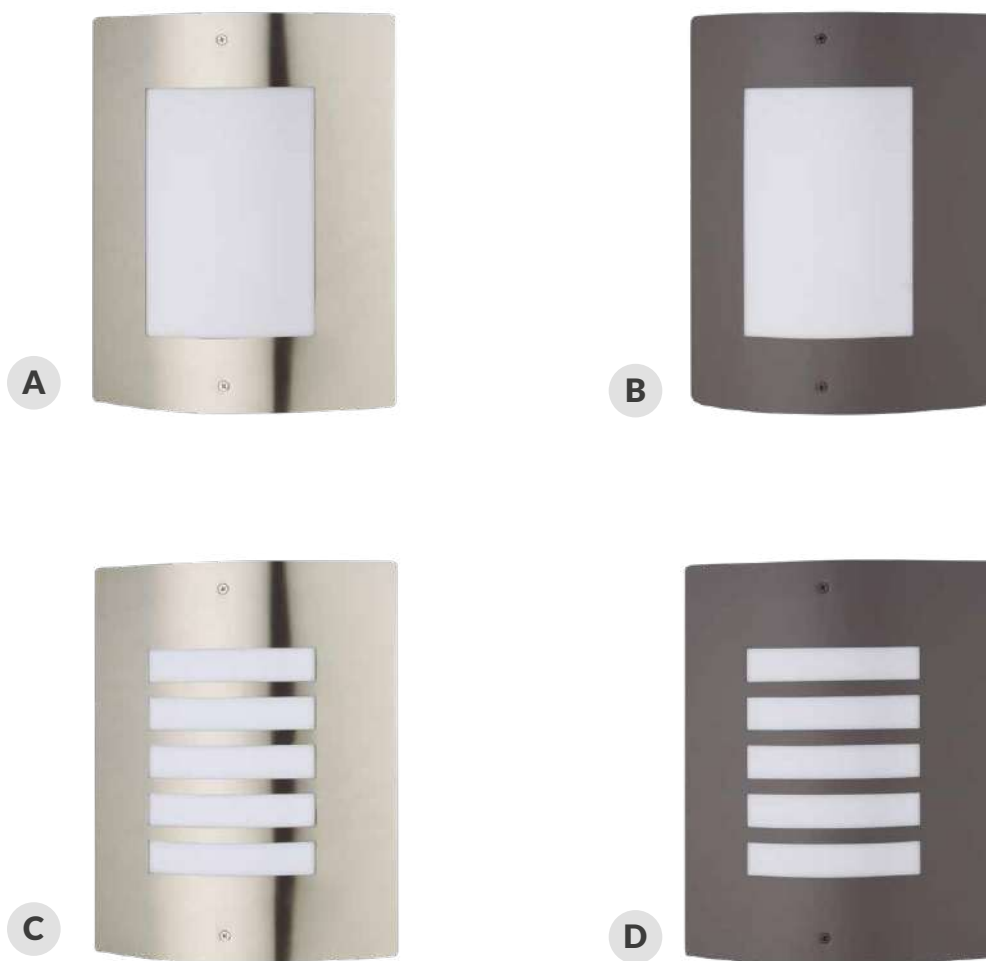

E27
 IP44
 220-240V
 50/60Hz

Aplique pared **acero inoxidable**

Material: **acero inoxidable**. Difusor: **PC**. Uso interior y exterior.

Referencia	Artículo	Potencia	Casquillo	Color	Embalaje
000701910	A	Máx. 60W	E27	● Níquel Satín	12
200200005	B	Máx. 60W	E27	● Gris antracita	12
000700081	C	Máx. 60W	E27	● Níquel Satín	12
200200006	D	Máx. 60W	E27	● Gris antracita	12

Gensi
SERIE



A



B



C



D

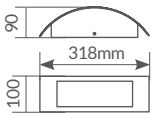

E27



IP44



220-240V



50/60Hz

Aplique pared acero inoxidable

Material: **acero inoxidable**. Difusor: **PC**. Uso interior y exterior.

Referencia	Artículo	Potencia	Casquillo	Color	Embalaje
200200007	A	Máx. 14W	E27	● Níquel Satín	12
200200008	B	Máx. 14W	E27	● Gris antracita	12
200200009	C	Máx. 14W	E27	● Níquel Satín	12
200200010	D	Máx. 14W	E27	● Gris antracita	12



A



B

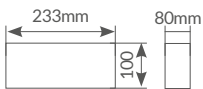

Aplique aluminio

Tipo: **empotrable**. Para todo tipo de lámparas E27. Incluye caja de empotrar.

Referencia	Artículo	Potencia	Casquillo	Color	Rejilla	Embalaje
000700791	A	Máx. 60W	E27	● Níquel Satín	No	20
000701912	B	Máx. 60W	E27	● Níquel Satín	Sí	18

Durgi
SERIE



C



D

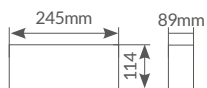

Aplique aluminio LED

Tipo: **empotrable**. Color: **níquel satín**. Incluye caja de empotrar.

Referencia	Artículo	Con difusor / Luminaria (360°)	Sin difusor / Fuente de luz (360°)	Luz	Rejilla	Embalaje
200205072	C	7W	700Lm	● 6000K	No	20
200205073	D	7W	700Lm	● 6000K	Sí	20

Befale

SERIE



A



B



C

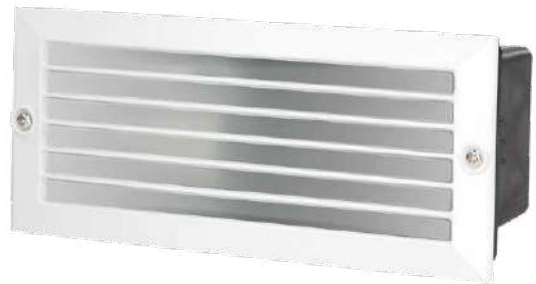

D



E27



IP44



220-240V



50/60Hz

Aplique pared

Material: **aluminio**. Difusor: **PC**. Incluye caja de empotrar. Uso interior y exterior.

Referencia	Artículo	Potencia	Casquillo	Color	Rejilla	Embalaje
200200013	A	Máx. 60W	E27	● Gris antracita	No	12
200200014	B	Máx. 60W	E27	○ Blanco	No	12
200200015	C	Máx. 60W	E27	● Gris antracita	Sí	12
200200016	D	Máx. 60W	E27	○ Blanco	Sí	12

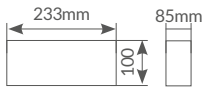

Caja de empotrar

Para referencias 000700791, 000701912, 000703405 y 000703406.

Referencia	Color	Embalaje
000701911	● Negro	50

Rejilla metálica



A



B

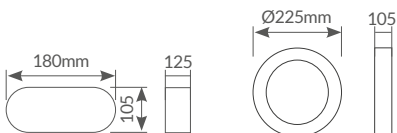

Aplique PVC

Difusor: **vidrio**. Con material aislante. Uso exterior.

Referencia	Artículo	Tipo	Potencia	Casquillo	Color	Rejilla	Embalaje
000700643	A	Ovalado	Máx. 60W	E27	○ Blanco	Sí	20
000700648	B	Redondo	Máx. 60W	E27	○ Blanco	No	12

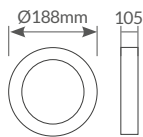
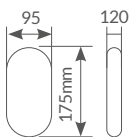

E27



IP44



220-240V



50Hz

Aplique PVC con rejilla

Difusor: **vidrio**. Con material aislante. Con rejilla de protección. Uso exterior.

Referencia	Tipo	Potencia	Casquillo	Color	Embalaje
000700152	Ovalado	Máx. 60W	E27	○ Blanco	24
000700153	Ovalado	Máx. 60W	E27	● Negro	24
000700156	Redondo	Máx. 60W	E27	○ Blanco	24
000700157	Redondo	Máx. 60W	E27	● Negro	24

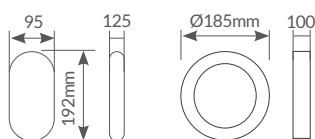

E27



IP44



220-240V



50Hz

Aplique redondo PVC

Difusor: **vidrio**. Con material aislante. Uso exterior.

Referencia	Tipo	Potencia	Casquillo	Color	Embalaje
000700644	Ovalado	Máx. 60W	E27	○ Blanco	24
000700645	Ovalado	Máx. 60W	E27	● Negro	24
000700646	Redondo	Máx. 60W	E27	○ Blanco	24
000700647	Redondo	Máx. 60W	E27	● Negro	24



A



B



C



D

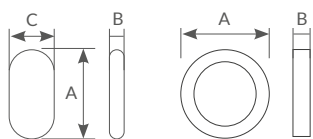

E27



IP44



220-240V



50Hz

Aplique aluminio

Difusor: **vidrio**. Material: **aluminio**. Color: **blanco**. Uso exterior.

Referencia	Artículo	Tipo	Potencia	Casquillo	Rejilla	Dimensión (AxBxC)	Embalaje
000700782	A	Ovalado	Máx. 60W	E27	Sí	210x105x110mm	20
000700783	B	Redondo	Máx. 60W	E27	Sí	Ø188x115mm	20
000700454	C	Semi-ovalado	Máx. 60W	E27	No	215x142x105mm	20
000700455	D	Semi-ovalado	Máx. 60W	E27	Sí	215x142x108mm	20

Sallo APLIQUE

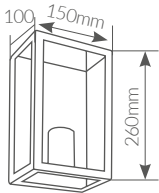

*Bombilla no incluida

Aplique de pared



IP44



110-240V



50/60Hz

Difusor **de vidrio**. Base **aluminio**. Bombilla no incluida. Uso exterior. Color: **negro**.

Referencia	Potencia máx.	Casquillo	Embalaje
200200004	14W	E27	10

Sabik APLIQUE

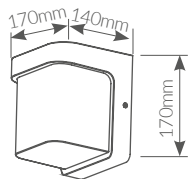

IP54



220-240V



50/60Hz

Aplique de pared

Material: **PC + ABS**. Bombilla no incluida. Uso exterior. Color: **antracita**. IK08.

Referencia	Potencia máx.	Casquillo	Embalaje
200200003	12W / Incandescencia 18W / B. Consumo & LED	E27	12

Meluco
SERIE



* Bombilla no incluida.

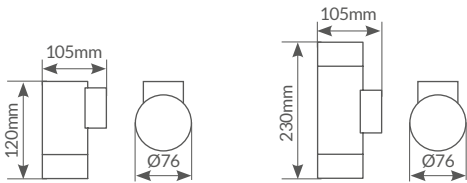

Aplique de pared

Material: **aluminio + plástico**. Bombilla no incluida. Uso exterior. IK08.

Referencia	Artículo	Potencia	Casquillo	Color	Embalaje
200200017	A	Máx. 35W	GU10	● Negro	20
200200018	B	Máx. 2x35W	2xGU10	● Negro	10



Mushie

SERIE



12W 18W

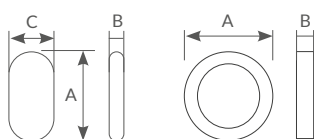

- 6500K
- 120°
- 20.000
- ≥80Ra
- 20.000h
- IP65
- 220-240V
- Hz

Aplique pared LED

Tipo: **para pared**. Color: **blanco**. Material: **plástico**.
 Incluye 15cm de cable para instalar **H03VV-F (2x0.75mm²)**. Uso exterior.

Referencia	Forma	Con difusor / Luminaria (360°)	Sin difusor / Fuente de luz (360°)	Luz	Dimensión (AxBxC)	Embalaje
200205068	Ovalada	12W / 960Lm	12W / 1320Lm	● 6500K	175x86x55mm	80
200205069	Ovalada	18W / 1440Lm	18W / 2000Lm	● 6500K	201x99x55mm	60
200205070	Redonda	12W / 960Lm	12W / 1320Lm	● 6500K	Ø145x60mm	60
200205071	Redonda	18W / 1440Lm	18W / 2000Lm	● 6500K	Ø165x60mm	40

Cercis
SERIE



Exterior Apliques

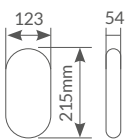

- 4200K
- 6500K
- 115°
- 15.000
- ≥80Ra
- 25.000h
- IP65
- 220-240V
- 50/60Hz

Aplique LED ovalado

Material: **PC + ABS**. Uso exterior.

Referencia	Con difusor / Luminaria (360°)	Sin difusor / Fuente de luz (360°)	Luz	Color	Embalaje
200205000	15W / 950Lm	15W / 1860Lm	4000K	<input type="radio"/> Blanco	20
200205001	15W / 950Lm	15W / 1860Lm	6500K	<input type="radio"/> Blanco	20
200205002	15W / 950Lm	15W / 1860Lm	4000K	<input checked="" type="radio"/> Negro	20
200205003	15W / 950Lm	15W / 1860Lm	6500K	<input checked="" type="radio"/> Negro	20

Oxalis

SERIE

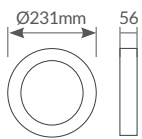

4000K



6500K



115°



15.000



≥80Ra



25.000h



IP65



220-240V



50/60Hz

Exterior Apliques

Aplique LED redondo

Material: **PC + ABS**. Uso exterior.

Referencia	Con difusor / Luminaria (360°)	Sin difusor / Fuente de luz (360°)	Luz	Color	Embalaje
200205004	15W / 950Lm	15W / 1860Lm	● 4000K	○ Blanco	20
200205005	15W / 950Lm	15W / 1860Lm	● 6500K	○ Blanco	20
200205006	15W / 950Lm	15W / 1860Lm	● 4000K	● Negro	20
200205007	15W / 950Lm	15W / 1860Lm	● 6500K	● Negro	20

Hitra

SERIE



12W

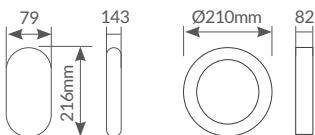

4200K



6500K



120°



200.000



≥80Ra



30.000h



IP54



220-240V



50Hz

Aplique pared LED

Material: **PC**. Color: **blanco**. Uso exterior.

Referencia	Forma	Con difusor / Luminaria (360°)	Sin difusor / Fuente de luz (360°)	Luz	Embalaje
200205039	Ovalada	12W / 840Lm	12W / 1200Lm	● 4200K	10
200205040	Ovalada	12W / 840Lm	12W / 1200Lm	● 6500K	10
200205041	Redonda	12W / 840Lm	12W / 1200Lm	● 4200K	10
200205042	Redonda	12W / 840Lm	12W / 1200Lm	● 6500K	10

Doko
SERIE



15W

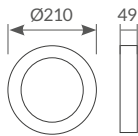
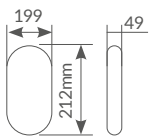

4000K



6000K



120°



100.000



≥80Ra



30.000h



IP54



220-240V



50/60Hz

Aplique pared LED

Tipo: **para pared**. Color: **blanco**. Material: **PC**. Uso exterior. **Tiempo regulable**: 10seg.±3seg. hasta 5min±1min. (Reg.). **Máx. distancia detección**: radio 9M. **Luz ambiental regulable**: <3-2000lux. **Rango de detección**: 140°. **Altura de instalación**: 1.8-2.5M.

Referencia	Forma	Con difusor / Luminaria (360°)	Sin difusor / Fuente de luz (360°)	Luz	Embalaje
200205057	Ovalada	15W / 1100Lm	13W / 1300Lm	● 4000K	20
200205058	Ovalada	15W / 1100Lm	13W / 1300Lm	● 6000K	20
200205059	Redonda	15W / 1100Lm	13W / 1300Lm	● 4000K	20
200205060	Redonda	15W / 1100Lm	13W / 1300Lm	● 6000K	20

Anthe

SERIE



A



B



C

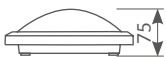
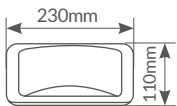

4000K



6500K



120°



100.000



≥80Ra



30.000h



IP65



220-240V



50/60Hz

Aplique pared LED

Material: **PC + ABS**. Fácil conexión. Uso exterior. Color: **antracita**. IK08.

Referencia	Artículo	Con difusor / Luminaria (360°)	Sin difusor / Fuente de luz (360°)	Luz	Embalaje
200205043	A	11W/1200Lm	11W/1390Lm	● 4000K	20
200205044	A	11W/1200Lm	11W/1390Lm	● 6500K	20
200205045	B	11W/650Lm	11W/1390Lm	● 4000K	20
200205046	B	11W/650Lm	11W/1390Lm	● 6500K	20
200205047	C	11W/350Lm	11W/1390Lm	● 4000K	20
200205048	C	11W/350Lm	11W/1390Lm	● 6500K	20

Kuito

SERIE

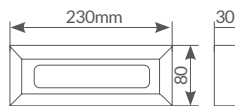
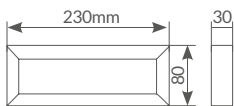

90°



100.000



≥80Ra



25.000h



IP65



220-240V



50/60Hz

Aplique pared LED

Material: **PC**. Color: **gris antracita**.

Temperatura regulable mediante botón trasero. Uso exterior.

Referencia	Artículo	Con difusor / Luminaria (360°)	Sin difusor / Fuente de luz (360°)	Luz	Embalaje
200205062	A	4W / 368Lm	4W / 446Lm	3000K - 4000K - 6000K	25
200205067	B	4W / 397Lm	4W / 444Lm	3000K - 4000K - 6000K	25

Padum

SERIE

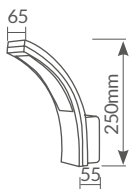

- 3000K
- 6000K
- 120°
- 100.000
- ≥80Ra
- 30.000h
- IP54
- 220-240V
- Hz

Aplique pared LED

Tipo: **para pared**. Material: **PC**. Uso exterior.

Referencia	Con difusor / Luminaria (360°)	Sin difusor / Fuente de luz (360°)	Luz	Color	Embalaje
200205049	15W/ 1200Lm	10.5W/ 1400Lm	3000K	Blanco	20
200205050	15W/ 1200Lm	10.5W/ 1400Lm	6000K	Blanco	20
200205051	15W/ 1200Lm	10.5W/ 1400Lm	3000K	Gris antracita	20
200205052	15W/ 1200Lm	10.5W/ 1400Lm	6000K	Gris antracita	20

Tegar

SERIE



Con sensor de movimiento

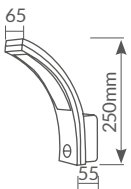

4200K



6000K



120°



100.000



≥80Ra



30.000h



IP54



220-240V



50/60Hz

Aplique pared LED con sensor

Tipo: **para pared**. Material: **PC**. Uso exterior. **Tiempo regulable**: 10seg.±3seg. hasta 5min±1min. (Reg.). **Máx. distancia detección**: radio 9M. **Luz ambiental regulable**: <3-2000lux. **Rango de detección**: 140°. **Altura de instalación**: 1.8-2.5M.

Referencia	Con difusor / Luminaria (360°)	Sin difusor / Fuente de luz (360°)	Luz	Color	Embalaje
200205053	15W / 1200Lm	10.5W / 1400Lm	● 4200K	○ Blanco	20
200205054	15W / 1200Lm	10.5W / 1400Lm	● 6000K	○ Blanco	20
200205055	15W / 1200Lm	10.5W / 1400Lm	● 4200K	● Gris antracita	20
200205056	15W / 1200Lm	10.5W / 1400Lm	● 6000K	● Gris antracita	20

Behali

LUZ EMERGENCIA



Con sensor de movimiento

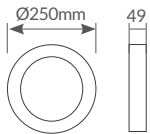

6000K



120°



100.000



≥80Ra



30.000h



IP44



110-240V



50Hz

Aplique LED emergencia + sensor movimiento





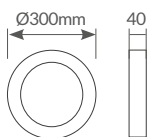

Tipo: pared / techo. Color: blanco. Material: PC. Tiempo regulable: 10seg.±3seg. hasta 5min±1min. (Reg.).
Máx. distancia detección: Pared 9M / Techo 6M. **Luz ambiental regulable:** <3-2000lux. **Rango de detección:** 160°/360°.
Altura de instalación: Pared 1.8-2.5M / Techo 2.2-4M. **Con luz de emergencia.** Potencia de emergencia: 1.2W(DC). 65Lm.
Autonomía: 5h. Batería de litio 3.7V/15000mAh. **Consumo stand-by:** 0.45W.

Referencia	Con difusor / Luminaria	Sin difusor / Fuente de luz (360°)	Luz	Embalaje
200205061	10W / 900Lm	9W / 1050Lm	● 6000K	10

Kamina



CON SENSOR



-  4000K
-  6000K
-  120°
-  100.000
-  ≥80Ra
-  50.000h
-  IP65
-  220-240V
-  50/60Hz

Plafón techo LED con sensor movimiento + crepuscular

Tipo: **techo**. Color: **blanco**. Material: **PC**. Uso exterior. **Tiempo regulable**: 10seg.±3seg. hasta 5min±1min. (Reg.).
Máx. distancia detección: 8M (radio) . **Luz ambiental regulable**: <3-2000lux.
Rango de detección: 360°. **Altura de instalación**: 2.2-4M.
Consumo stand-by: 0.5W.

Referencia	Con difusor / Luminaria	Sin difusor / Fuente de luz (360°)	Luz	Embalaje
203610007	20W / 2500Lm	19W / 2700Lm	 4000K	10
203610008	20W / 2500Lm	19W / 2700Lm	 6000K	10

Lainio

CON SENSOR



16W

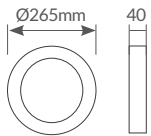

-  4000K
-  6000K
-  120°
-  100.000
-  ≥80Ra
-  50.000h
-  IP65
-  220-240V
-  Hz

Plafón LED con sensor movimiento + crepuscular + stand-by

Tipo: **pared / techo**. Color: **blanco**. Material: **PC**. Uso exterior. **Tiempo regulable:** 10seg.±3seg. hasta 12min±1min. (Reg.).
Máx. distancia detección: Pared 5-15M / Techo 2-8M (radio). **Luz ambiental regulable:** <3-2000lux.
Rango de detección: Pared 180° / Techo 360°. **Altura de instalación:** Pared 1.5-3.5M / Techo 2-4M.
Consumo stand-by: 0.9W.





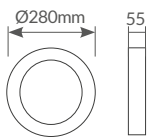

Referencia	Con difusor / Luminaria	Sin difusor / Fuente de luz (360°)	Luz	Embalaje
203610005	16W / 1300Lm	15W / 1500Lm	 4000K	10
203610006	16W / 1300Lm	15W / 1500Lm	 6000K	10

Roma
PLAFÓN





18W



-  4200K
-  6500K
-  120°
-  15.000
-  ≥80Ra
-  30.000h
-  IP54
-  220-240V
-  Hz

Plafón techo LED

Material: **PC**. LED driver incluido. Uso exterior. **IK10**.

Referencia	Con difusor / Luminaria	Sin difusor / Fuente de luz (360°)	Luz	Embalaje
203605021	18W / 1500Lm	18W / 1800Lm	 4200K	12
203605022	18W / 1500Lm	18W / 1800Lm	 6500K	12



Intra
Bañador

Exterior Bañadores

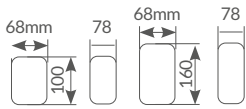
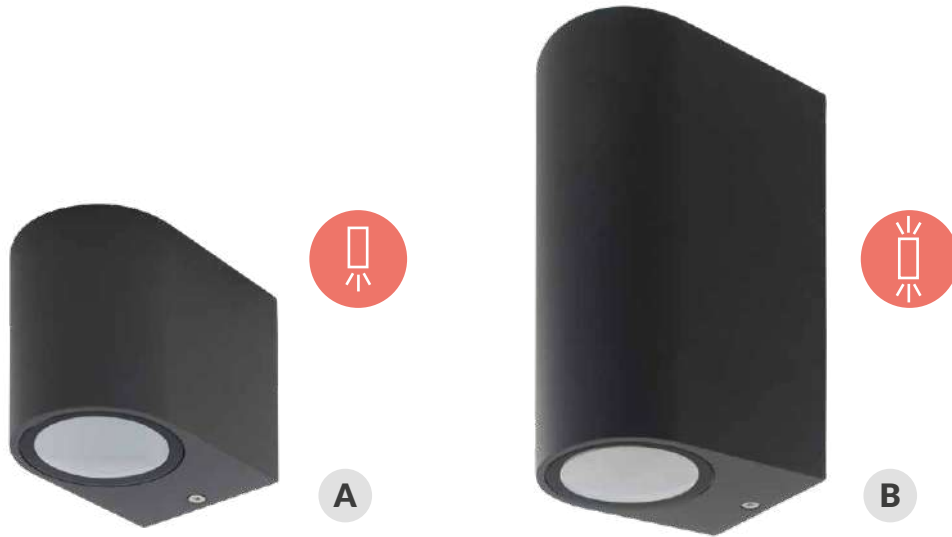

Bañador de pared

Material: **aluminio**. Bombilla no incluida. Uso exterior.

Referencia	Artículo	Potencia	Casquillo	Color	Embalaje
200200001	A	Máx. 35W	GU10	● Gris antracita	20
200200002	B	Máx. 2x35W	2xGU10	● Gris antracita	20

Feshi
Bañador

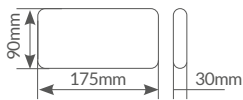
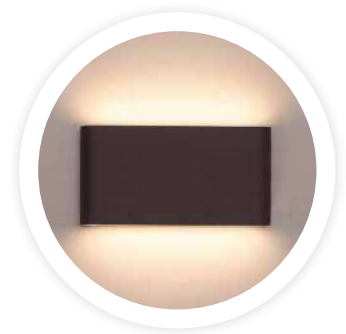

110°



10.000



≥80Ra



30.000h



IP54



220-240V



50/60Hz

Bañador de pared cuadrado

Cambio de tonalidad de luz a través de un botón. Material: **aluminio**. Color: **gris antracita**. Uso exterior.

Referencia	Con difusor / Luminaria	Sin difusor / Fuente de luz (360°)	Luz	Embalaje
200205076	10W / 700Lm	10W / 950Lm	CCT (3000-4000-6500K)	20



Pinda
BAÑADOR

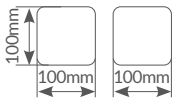
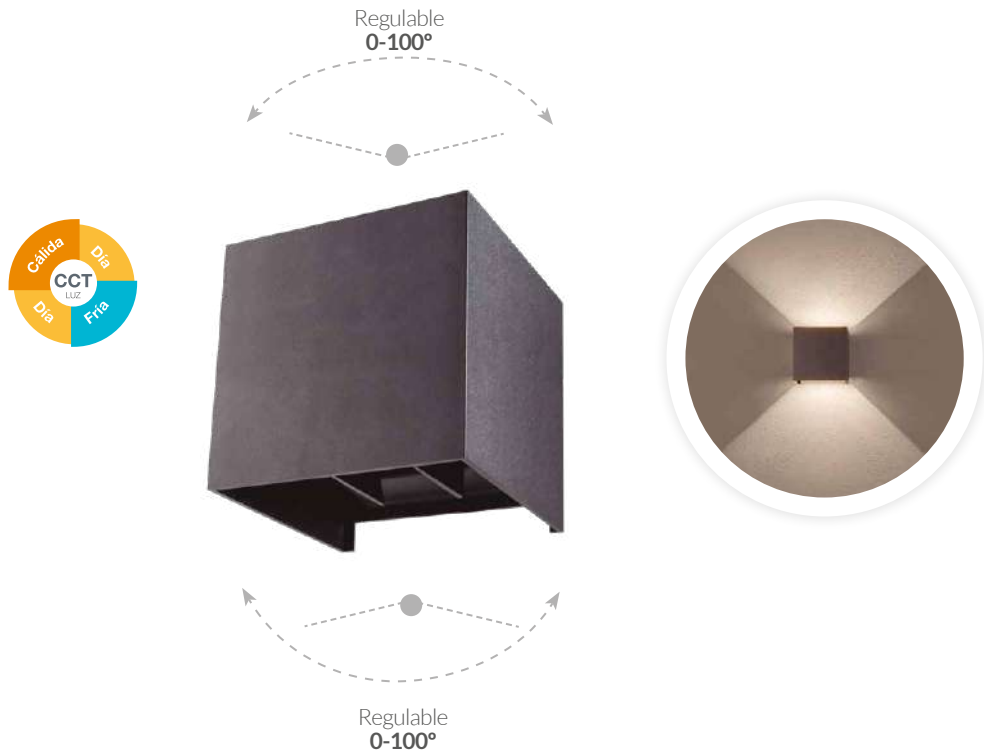

- 120°
- 10.000
- ≥80Ra
- 30.000h
- IP54
- 220-240V
- 50/60Hz

Bañador de pared cuadrado

Cambio de tonalidad de luz a través de un botón. Material: **aluminio**. Forma: **cuadrada**. Color: **gris antracita**. Uso exterior.

Referencia	Con difusor / Luminaria	Sin difusor / Fuente de luz (360°)	Luz	Embalaje
200205074	7W / 420Lm	7W / 665Lm	CCT (3000-4000-6500K)	20

Sumbe

BAÑADOR

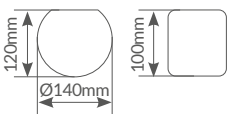

-  120°
-  10.000
-  ≥80Ra
-  30.000h
-  IP54
-  220-240V
-  50/60Hz

Bañador de pared redondo

Cambio de tonalidad de luz a través de un botón. Material: **aluminio**. Forma: **redonda**. Color: **gris antracita**. Uso exterior.

Referencia	Con difusor / Luminaria	Sin difusor / Fuente de luz (360°)	Luz	Embalaje
200205075	7W / 420Lm	7W / 665Lm	CCT (3000-4000-6500K)	20



Piscina

PROYECTOR

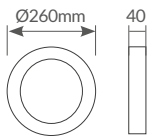

- 3000K
- 6500K
- RGB
- 120°
- ≥20.000
- ≥80Ra
- 30.000h
- IP68
- 12-15V
- Hz

Exterior Piscina

Proyector LED para piscina

Tipo: **superficie**. Material: **PC**. El proyector RGB tiene **memoria** y puede ser controlada por el interruptor. Con el mando y el controlador **se pueden controlar varias bombillas a la vez**. **Máx. distancia funcionamiento 30M** libre de obstáculos. Ideal para piscinas. Longitud cable: 2M.

Referencia	Potencia	Lúmenes	Luz	Embalaje
201400008	18W	1800Lm	3000K	10
201400009	18W	1800Lm	6500K	10
201400010	18W	-	RGB	10
000704747	Controlador RF RGB y mando para luminaria piscina			

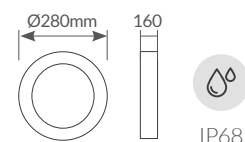

Caja estanca **empotrable**

Incluye **adaptador de silicona** para las medidas entre 7 y 8.8mm para la entrada del cable de instalación al nicho. Para las medidas de más de 8.8mm, se podrán usar prensaestopas sin necesidad de utilizar el adaptador de silicona.

Referencia	Grosor cable	Embalaje
201400001	Mínimo 7mm / Máximo 13mm	4
201495002	Kit tuercas para adaptar los recambios de la ref. 201495001	

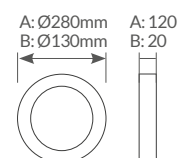

Kit recambios **para caja estanca**

Incluye adaptador de silicona para el cable de la instalación, soporte, junta tórica. Incluye adaptador de silicona para las medidas entre 7 y 8.8mm para la entrada del cable de instalación al nicho. Para las medidas de más de 8.8mm, se podrán usar prensaestopas sin necesidad de utilizar el adaptador de silicona.

Referencia	Artículo	Descripción	Accesorio	Embalaje
201495003	A	Kit recambio soporte y aro embellecedor	Para ref. 201400001	6
201495004	B	Kit recambio junta tórica	Para ref. 201400001	48







Bombilla

PROYECTOR

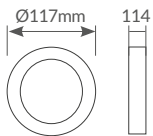

Exterior Piscina



-  3000K
-  6500K
-  RGB
-  GX53
-  120°
-  ≥20.000
-  ≥80Ra
-  30.000h
-  IP68
-  12-15V
-  Hz

Bombilla piscina LED PAR56

La bombilla RGB tiene **memoria** y puede ser controlada por el interruptor. Con el mando y el controlador **se pueden controlar varias bombillas a la vez**. Ideal para piscinas.

Referencia	Potencia	Lúmenes	Luz	Embalaje
201400002	18W	1800Lm	 3000K	12
201400003	18W	1800Lm	 6500K	12
201400004	18W	-	 RGB	12
201400005	35W	3100Lm	 3000K	12
201400006	35W	3100Lm	 6500K	12
201400007	35W	-	 RGB	12
000704747	Controlador RF RGB y mando para luminaria piscina			



Emergencia

Iluminación





Marang

LUMINARIA

0.75W

1.5W

3W



Autonomía hasta 3h.



Instalación en superficie o empotrable

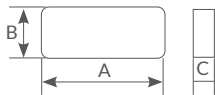

6000K



50.000



≥80Ra



30.000h.



IP20



110-260V



50/60Hz

Luminaria de emergencia

Tipo: **superficie / empotrable**. Material: **PC**. Uso interior. Corriente: AC/DC. Posibilidad de empotrar. Batería: 3.6V 1500mAh Ni-Cd de alta temperatura (reemplazable). Autonomía: 3h.

Referencia	Potencia	Lúmenes	Luz	mAh	Dimensión (AxBxC)	Embalaje
000703478	0.75W	100Lm	● 6000K	1200mAh	238x80x40mm	50
000703479	1.5W	150Lm	● 6000K	1500mAh	238x80x40mm	50
000703480	3W	300Lm	● 6000K	1800mAh	238x80x40mm	50
201095005	Recambio batería 1200 mAh para luminaria 000703478					
201095006	Recambio batería 1500 mAh para luminaria 000703479					
201095003	Recambio batería para luminaria Marang ref.000703480					

Gunza
LUMINARIA



Emergencia Luminaria emergencia

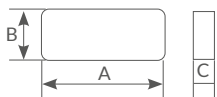

- 6000K
- 50.000
- ≥80Ra
- 30.000h.
- IP20
- 110-260V
- 50/60Hz

Luminaria de **emergencia con autotest**

Tipo: **superficie / empotrable**. Material: **PC**. Uso interior. Corriente: AC/DC. Posibilidad de empotrar.
Batería: 3.6V 2500mAh Ni-MH de alta temperatura (reemplazable). Autonomía: 3h.

Referencia	Potencia	Lúmenes	Luz	mAh	Dimensión (AxBxC)	Embalaje
201000069	3W	300Lm	6000K	2500mAh	238x80x40mm	50
201095011	Recambio batería para luminaria Gunza ref. 201000069					

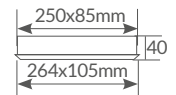

Accesorio para empotrar luminaria de emergencia

Material: **PC**. Para luminarias **Gunza** y **Marang**. **IP65**.

Referencia	Empotramiento	Embalaje
000703481	250x85mm	30

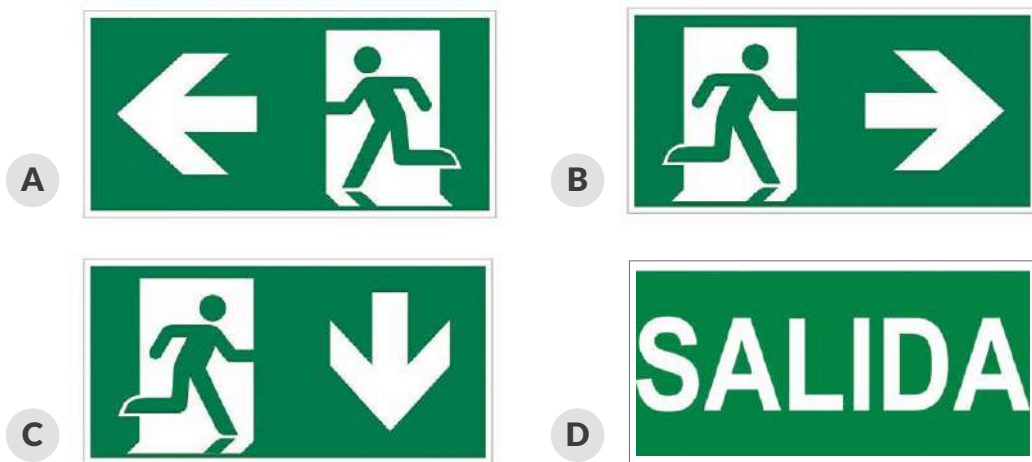

Adhesivo para luminaria de emergencia

Adhesivo para colocar sobre las luminarias de emergencia.

Referencia	Artículo	Modelo	Embalaje
201095007	A	Flecha derecha	50
201095008	B	Flecha izquierda	50
201095009	C	Flecha abajo	50
201095010	D	Salida	50



Bombillas, tubos, campanas y farolas

Iluminación





A



B



C



D



E



4200K



6400K



10.000h.



230V



50Hz

Bombilla PLC

Uso interior.

Referencia	Artículo	Potencia	Lúmenes	Casquillo	Luz	Dimensión	Embalaje
002000840	A	26W	1716Lm	G24d-3-2pin	● 6400K	Ø28x174mm	25/200
002003315	B	26W	1716Lm	G24d-4pin	● 6400K	Ø28x165mm	25/200
002000609	C	9W	583Lm	G23-2pin	● 4200K	Ø28x165mm	25/200
002000610	C	11W	897Lm	G23-2pin	● 4200K	Ø28x233mm	25/200
002001167	D	9W	583Lm	2G7	● 4200K	Ø11x145mm	25/200
002001168	D	11W	897Lm	2G7	● 4200K	Ø11x210mm	25/200
002000611	E	36W	2916Lm	2G11	● 4200K	Ø40x415mm	10/50

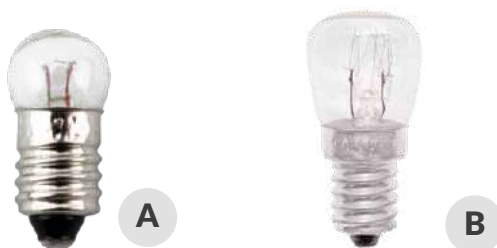

Bombilla incandescente

Uso interior.

Referencia	Artículo	Tipo	Potencia	Lúmenes	Luz	Casquillo	Voltaje	Dimensión	Embalaje
002000844	A	Mini	-	-	● 2700K	E10	4.8V	Ø10x23mm	25/2000
002000582	B	PYGMY hornos	15W	70Lm	● 2700K	E14	220-240V	Ø22x48mm	50/1000
002000583	B	PYGMY hornos	25W	90Lm	● 2700K	E14	220-240V	Ø22x48mm	50/1000



Bombilla ECO halógena lineal



R7s



360°



2.000h.



230V



50Hz

Hasta **20% de ahorro**. Uso interior.

Referencia	Potencia	Lúmenes	Casquillo	Longitud)	Embalaje
002001172	80W	1400Lm	R7s	78mm	10/1000
002001173	120W	2300Lm	R7s	78mm	10/1000
002001850	80W	1400Lm	R7s	118mm	10/500
002001851	120W	2300Lm	R7s	118mm	10/500



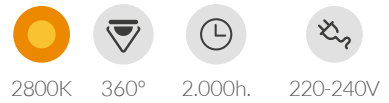

Bombilla halógena Bi-Pin

Hasta **30% de ahorro.** Uso interior.

Referencia	Potencia	Lúmenes	Casquillo	Luz	Dimensión	Embalaje
002000440	28W	350Lm	G9	● 2800K	Ø12.5x40mm	10/1000
205205003	42W	750Lm	G9	● 2800K	Ø12.5x40mm	10/1000

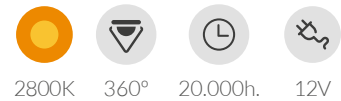

Bombilla halógena Bi-Pin

Hasta **30% de ahorro.** Uso interior.

Referencia	Potencia	Lúmenes	Casquillo	Luz	Dimensión	Embalaje
205205002	50W	830Lm	G6.35	● 2800K	Ø10x44mm	10/1000

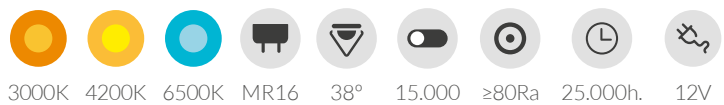

Bombilla LED **dicroica**

LED SMD. Material: **crystal**. Sustituye a las dicroicas tradicionales. Uso interior.

Referencia	Potencia	Lúmenes útiles (90°)	Lúmenes nominales (360°)	Casquillo	Luz	Dimensión	Embalaje
200621069	5.5W	445Lm	490Lm	MR16	● 3000K	Ø50x54mm	10/100
200621070	5.5W	445Lm	490Lm	MR16	● 4200K	Ø50x54mm	10/100
200621071	5.5W	445Lm	490Lm	MR16	● 6500K	Ø50x54mm	10/100

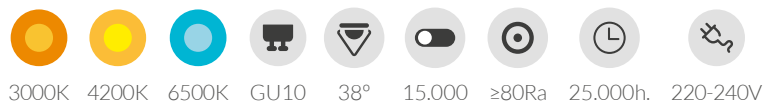

Bombilla LED **dicroica**

LED SMD. Material: **crystal**. Sustituye a las dicroicas tradicionales. Uso interior.

Referencia	Potencia	Lúmenes útiles (90°)	Lúmenes nominales (360°)	Casquillo	Luz	Dimensión	Embalaje
200621066	5W	445Lm	490Lm	GU10	● 3000K	Ø50x54mm	10/100
200621068	5W	445Lm	490Lm	GU10	● 6500K	Ø50x54mm	10/100



5W

Bombilla LED dichroica

- 3000K
- 4200K
- 6000K
- MR16
- 100°
- 15.000
- ≥80Ra
- 25.000h.
- 12V

LED SMD. Material: **aluminio + PC**. Sustituye a las dichroicas tradicionales. Uso interior.

Referencia	Potencia	Lúmenes	Casquillo	Luz	Dimensión	Embalaje
200621018	5W	500Lm	MR16	3000K	Ø50x50mm	10/100
200621019	5W	500Lm	MR16	4200K	Ø50x50mm	10/100
200621020	5W	500Lm	MR16	6000K	Ø50x50mm	10/100



3.5W

Bombilla LED dichroica

- 3000K
- 4200K
- 6000K
- GU10
- 120°
- 15.000
- ≥80Ra
- 20.000h.
- 220-240V

LED SMD. Material: **aluminio + PC**. Sustituye a las dichroicas tradicionales. Uso interior.

Referencia	Potencia	Lúmenes	Casquillo	Luz	Dimensión	Embalaje
200621006	3.5W	300Lm	GU10	3000K	Ø50x56.5mm	10/100
200621007	3.5W	300Lm	GU10	4200K	Ø50x56.5mm	10/100
200621008	3.5W	300Lm	GU10	6000K	Ø50x56.5mm	10/100



5.5W

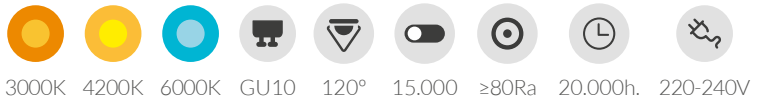

Bombilla LED dicroica

LED SMD. Material: **aluminio + PC**. Sustituye a las dicroicas tradicionales. Uso interior.

Referencia	Potencia	Lúmenes	Casquillo	Luz	Dimensión	Embalaje
200621009	5.5W	500Lm	GU10	● 3000K	Ø50x56.5mm	10/100
200621010	5.5W	500Lm	GU10	● 4200K	Ø50x56.5mm	10/100
200621011	5.5W	500Lm	GU10	● 6000K	Ø50x56.5mm	10/100



7W



Bombilla LED dicroica

LED SMD. Sustituye a las dicroicas tradicionales. Uso interior.

Referencia	Potencia	Lúmenes útiles (90°)	Lúmenes nominales (360°)	Casquillo	Luz	Dimensión	Embalaje
200621038	7W	500Lm	580Lm	GU10	● 3000K	Ø49x53mm	10/100
200621039	7W	500Lm	580Lm	GU10	● 4200K	Ø49x53mm	10/100
200621040	7W	500Lm	580Lm	GU10	● 6000K	Ø49x53mm	10/100



Bombillas, tubos y campanas Bombillas LED



Bombilla LED dicroica

- 3000K
- 4200K
- 6000K
- GU10
- 120°
- 15.000
- ≥80Ra
- 20.000h.
- 220-240V

LED SMD. Sustituye a las dicroicas tradicionales. Uso interior.

Referencia	Potencia	Lúmenes	Casquillo	Luz	Dimensión	Embalaje
200621012	7.5W	700Lm	GU10	3000K	Ø50x56.5mm	10/100
200621013	7.5W	700Lm	GU10	4200K	Ø50x56.5mm	10/100
200621014	7.5W	700Lm	GU10	6000K	Ø50x56.5mm	10/100



Bombilla LED dicroica

- 3000K
- 4200K
- 6000K
- GU10
- 120°
- 15.000
- ≥80Ra
- 20.000h.
- 220-240V

LED SMD. Sustituye a las dicroicas tradicionales. Uso interior.

Referencia	Potencia	Lúmenes	Casquillo	Luz	Dimensión	Embalaje
200621015	10W	1000Lm	GU10	3000K	Ø50x56.5mm	10/100
200621016	10W	1000Lm	GU10	4200K	Ø50x56.5mm	10/100
200621017	10W	1000Lm	GU10	6000K	Ø50x56.5mm	10/100



Bombilla LED
dicroica regulable

- 3000K
- 6000K
- GU10
- 100°
- 100.000
- ≥80Ra
- 25.000h.
- 175-265V

LED SMD. Material: **PC + aluminio**. **Regulación TRIAC**. Regulable en **intensidad**.
Sustituye a las dicroicas tradicionales. Uso interior. IK05.

Referencia	Potencia	Lúmenes	Casquillo	Luz	Dimensión	Embalaje
200621029	6W	451Lm	GU10	3000K	Ø50x55mm	10/100
200621030	6W	451Lm	GU10	6000K	Ø50x55mm	10/100



Bombilla LED
dicroica regulable

- 3000K
- 6000K
- GU10
- 100°
- 100.000
- ≥80Ra
- 25.000h.
- 175-265V

LED SMD. Material: **PC + aluminio**. Regulable **por interruptor** en **3 intensidades: 100%, 50 % y 30%**.
No necesita regulador. Sustituye a las dicroicas tradicionales. Uso interior.

Referencia	Potencia	Lúmenes	Casquillo	Luz	Dimensión	Embalaje
200621031	6W	500Lm	GU10	3000K	Ø50x55mm	10/100
200621032	6W	500Lm	GU10	6000K	Ø50x55mm	10/100



2W

Bombilla LED ultrabrillo

- 3000K
- MR11
- 45°
- 15.000
- ≥80Ra
- 25.000h.
- 12V

LED SMD. Sustituye a las dicroicas tradicionales. Uso interior.

Referencia	Potencia	Lúmenes útiles (90°)	Lúmenes nominales (360°)	Casquillo	Luz	Dimensión	Embalaje
200621027	2W	220Lm	251Lm	MR11	● 3000K	Ø35x35mm	10/200



2W

Bombilla LED ultrabrillo

- 3000K
- GU10
- 38°
- 15.000
- ≥80Ra
- 25.000h.
- IP20
- 220-240V

LED SMD. Material: **aluminio + PC**. Sustituye a las dicroicas tradicionales. Uso interior. **IK8**.

Referencia	Potencia	Lúmenes útiles (90°)	Lúmenes nominales (360°)	Casquillo	Luz	Dimensión	Embalaje
200621028	2W	180Lm	212Lm	GU10	● 3000K	Ø35x50mm	10/100



Bombilla LED
esférica decorativa



LED SMD. Tipo: decorativa. **IP20**. Uso interior.

Referencia	Potencia	Casquillo	Luz	Dimensión	Embalaje
200605005	1W	E27	● Azul	Ø45x65mm	10/100
200605006	1W	E27	● Rojo	Ø45x65mm	10/100
200605007	1W	E27	● Amarillo	Ø45x65mm	10/100
200605008	1W	E27	● Verde	Ø45x65mm	10/100



Bombilla LED
estándar decorativa



LED SMD. Tipo: decorativa. **IP20**. Uso interior.

Referencia	Potencia	Casquillo	Luz	Dimensión	Embalaje
200605009	1W	E27	● Azul	Ø60x105mm	10/100
200605010	1W	E27	● Rojo	Ø60x105mm	10/100
200605011	1W	E27	● Amarillo	Ø60x105mm	10/100
200605012	1W	E27	● Verde	Ø60x105mm	10/100



8.5W

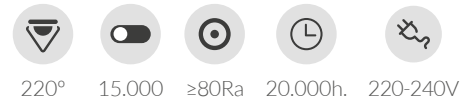

Bombilla LED estándar RGB + CCT

Regulable en intensidad luminosa y temperatura regulable. Modo noche.
 Posibilidad de regular de forma gradual con memoria del último estado de color.
 Con mando a distancia (máx. 5M). Se pueden controlar varias bombillas con el mismo mando. Uso interior. IP20.

Referencia	Potencia	Lúmenes	Casquillo	Luz	Dimensión	Embalaje
200601069	8.5W	806Lm	E27	● RGB + CCT	Ø60x110mm	10/100

Starlight
SERIE

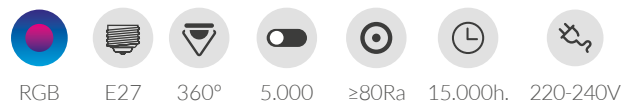

Bombilla LED decorativa

Decorativa. Uso interior.

Referencia	Artículo	Tipo	Potencia	Lúmenes	Casquillo	Luz	Dimensión	Embalaje
002004843	A	Globo G95	2W	50Lm	E27	● RGB	Ø95x127mm	50
002004844	B	Globo G125	2W	50Lm	E27	● RGB	Ø125x170mm	12



- 6000K
- E27
- 360°
- 12.500
- ≥80Ra
- 25.000h.
- 220-240V

Bombilla LED 3U

Uso interior.

Referencia	Potencia	Lúmenes	Casquillo	Luz	Dimensión	Embalaje
200606009	12W	1200Lm	E27	● 6000K	Ø42x163mm	10/100



- 3000K
- GU10
- 36°
- 15.000
- ≥80Ra
- 30.000h.
- 85-255V

Bombilla LED AR111

Uso interior.

Referencia	Potencia	Lúmenes útiles (90°)	Lúmenes nominales (360°)	Casquillo	Luz	Dimensión	Embalaje
200646000	12W	954Lm	1000Lm	GU10	● 3000K	Ø111x54mm	10/40



Bombillas, tubos y campanas Bombillas LED



- 4200K
- GX53
- 120°
- 15.000
- ≥80Ra
- 25.000h.
- 170-250V

Bombilla LED tipo pastilla

Uso interior.

Referencia	Potencia	Lúmenes	Casquillo	Luz	Dimensión	Embalaje
200665001	7W	700Lm	GX53	● 4200K	Ø75x29mm	10/100



- 4200K
- 6000K
- E14
- 360°
- 30.000
- ≥80Ra
- 15.000h.
- 220-240V

Bombilla pebetera LED E14

Ideal para sustituir en frigoríficos, flexos,... Uso interior.

Referencia	Potencia	Lúmenes	Casquillo	Luz	Dimensión	Embalaje
200625003 ★	2W	200Lm	E14	● 4200K	Ø22x50mm	20/500
200625001	2W	200Lm	E14	● 6000K	Ø22x50mm	20/500

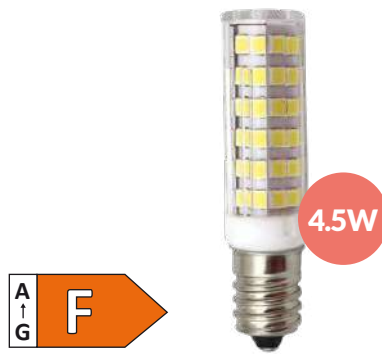

Bombilla tubular LED E14

-  3000K
-  6000K
-  E14
-  360°
-  30.000
-  ≥80Ra
-  15.000h.
-  220-240V

Ideal para sustituir en frigoríficos, flexos, campanas extractoras ... Uso interior.

Referencia	Potencia	Lúmenes	Casquillo	Luz	Dimensión	Embalaje
200645001	4.5W	460Lm	E14	 3000K	15.5x64mm	20/500
200645002	4.5W	460Lm	E14	 6000K	15.5x64mm	20/500

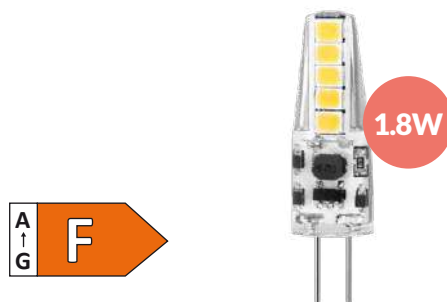

Bombilla LED SMD

-  3000K
-  G4
-  270°
-  12.500
-  ≥80Ra
-  20.000h.
-  AC/DC 12V

Uso interior.

Referencia	Potencia	Lúmenes	Casquillo	Luz	Dimensión	Embalaje
200675020	1.8W	185Lm	G4	 3000K	Ø10x37mm	20/200





Bombilla LED SMD

- 3000K
- G4
- 330°
- 15.000
- ≥80Ra
- 15.000h.
- 220-240V

Uso interior.

Referencia	Potencia	Lúmenes	Casquillo	Luz	Dimensión	Embalaje
200675042	1.5W	160Lm	G4	3000K	Ø11x38mm	20/200



Bombilla LED SMD

- 3000K
- 6000K
- G4
- 270°
- 12.500
- ≥80Ra
- 20.000h.
- AC/DC 12V

Uso interior.

Referencia	Potencia	Lúmenes	Casquillo	Luz	Dimensión	Embalaje
200675021	2.2W	240Lm	G4	3000K	Ø13x37mm	20/200
200675022	2.2W	240Lm	G4	6000K	Ø13x37mm	20/200



3W



- 3000K
- 4200K
- 6000K
- G9
- 360°
- 30.000
- ≥80Ra
- 15.000h.
- 220-240V

Bombilla LED G9

Ideal para sustituir en frigoríficos, flexos, campanas extractoras ... Uso interior.

Referencia	Potencia	Lúmenes	Casquillo	Luz	Dimensión	Embalaje
200675027	3W	360Lm	G9	3000K	17x50mm	20/500
200675028	3W	360Lm	G9	4200K	17x50mm	20/500
200675029	3W	360Lm	G9	6000K	17x50mm	20/500



4.8W



- 330°
- 15.000h.
- 220-240V

Bombilla LED G9

Uso interior. Dim.: Ø19x56mm.

Referencia	Potencia	Lúmenes	Luz	Embalaje
200675032	4.8W	530Lm	3000K	20/500
200675033	4.8W	530Lm	6000K	20/500

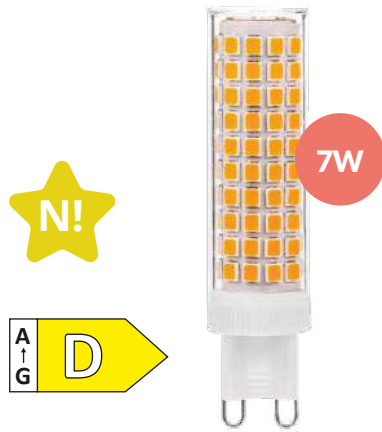

Bombilla LED G9

Uso interior. Dim.: Ø18.5x75mm.

Referencia	Potencia	Lúmenes	Luz	Embalaje
200675043	7W	1000Lm	● 3000K	20/200
200675044	7W	1000Lm	● 6000K	20/200

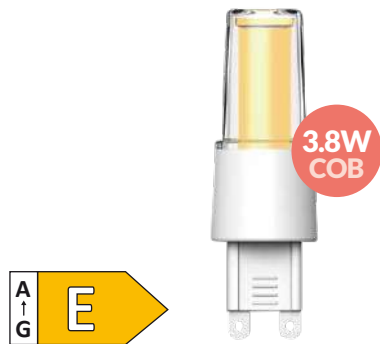

Bombilla LED G9

Uso interior.

Referencia	Potencia	Lúmenes	Casquillo	Luz	Dimensión	Embalaje
200675030	3.8W	450Lm	G9	● 3000K	Ø19x59mm	20/500
200675031	3.8W	450Lm	G9	● 6000K	Ø19x59mm	20/500



Bombilla LED estándar

- 3000K
- E27
- 360°
- 7.500
- ≥80Ra
- 15.000h.
- 220-240V

Decorativa. Filamento: **38mm**. Uso interior.

Referencia	Artículo	Tipo	Potencia	Lúmenes	Casquillo	Luz	Dimensión	Embalaje
200671000	A	Estándar	6W	630Lm	E27	● 3000K	Ø60x105mm	10/100
200671001	B	Estándar	7W	810Lm	E27	● 3000K	Ø60x105mm	10/100
200671009	C	Esférica	4W	470Lm	E27	● 3000K	Ø45x72mm	10/100
200671002	D	Vela	4W	470Lm	E14	● 3000K	Ø35x98mm	20/100



Bombillas, tubos y campanas Bombillas LED

Vintage
SERIE



- 2500K
- E27
- 360°
- 7.500
- ≥80Ra
- 15.000h.
- 220-240V

Bombilla LED globo

Decorativa. Filamento: **52mm**. Uso interior.

Referencia	Artículo	Tipo	Potencia	Lúmenes	Casquillo	Luz	Dimensión	Embalaje
200671005	A	G80	7W	680Lm	E27	2500K	Ø80x117mm	50
200671006	B	G95	7W	680Lm	E27	2500K	Ø95x135mm	20
200671007	C	G125	7W	680Lm	E27	2500K	Ø125x175mm	20

Vintage
SERIE

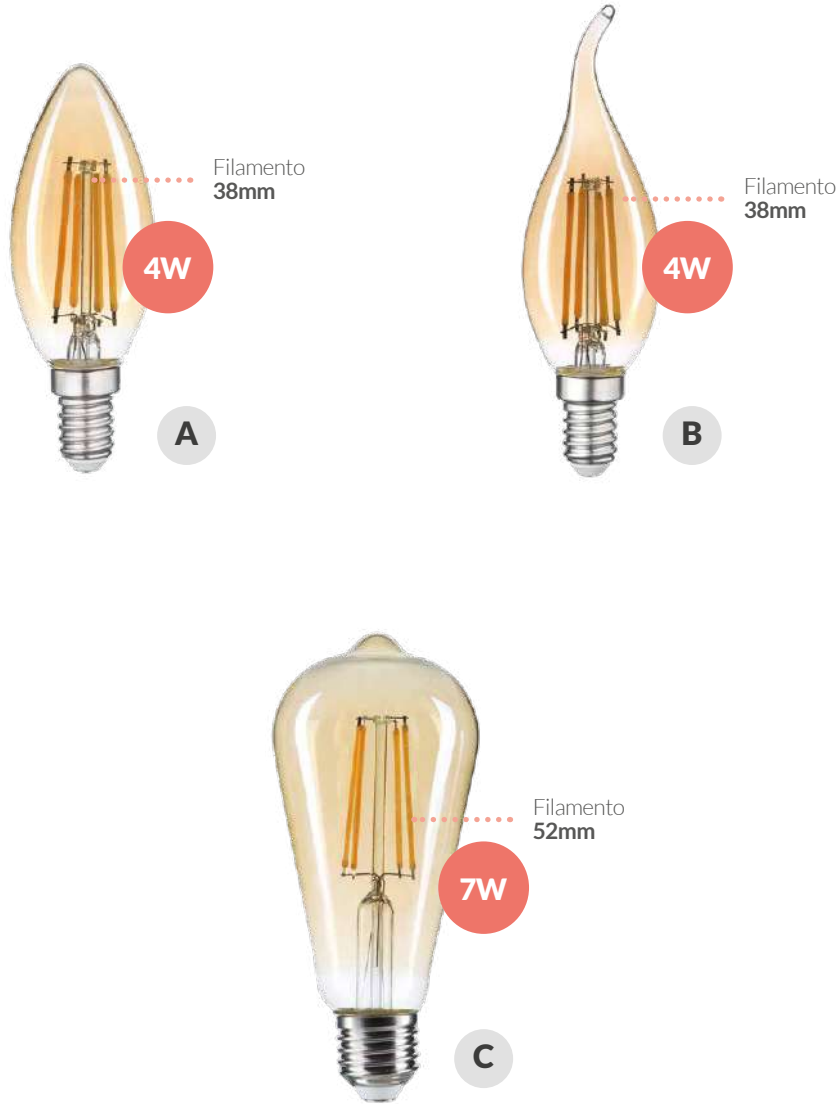

Bombillas, tubos y campanas Bombillas LED

Bombilla LED vintage

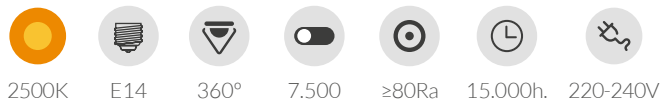

Decorativa. Filamento: **38mm** (Velas) / **52mm** (Pera). Uso interior.

Referencia	Artículo	Tipo	Potencia	Lúmenes	Casquillo	Luz	Dimensión	Embalaje
200671004	A	Vela	4W	400Lm	E14	● 2500K	Ø35x98mm	20/100
200671003	B	Soplo viento	4W	400Lm	E14	● 2500K	Ø35x120mm	20/100
200671008	C	Pera	7W	680Lm	E27	● 2500K	Ø64x140mm	50

Cristal

SERIE



Bombillas, tubos y campanas Bombillas LED

Bombilla LED cristal



Material: **cristal**. Uso interior.

Referencia	Artículo	Tipo	Potencia	Lúmenes	Casquillo	Luz	Dimensión	Embalaje
200601051	A	Estándar	9W	1200Lm	E27	3000K	Ø60x108mm	10/50
200601065 ★	A	Estándar	9W	1200Lm	E27	4000K	Ø60x108mm	10/50
200601052	A	Estándar	9W	1200Lm	E27	6500K	Ø60x108mm	10/50
200601053	B	Estándar	11W	1521Lm	E27	3000K	Ø60x108mm	10/50
200601066 ★	B	Estándar	11W	1521Lm	E27	4000K	Ø60x108mm	10/50
200601054	B	Estándar	11W	1521Lm	E27	6500K	Ø60x108mm	10/50
200626010	C	Globo	16W	2300Lm	E27	3000K	Ø95x140mm	20
200626012 ★	C	Globo	16W	2300Lm	E27	4000K	Ø95x140mm	20
200626011	C	Globo	16W	2300Lm	E27	6500K	Ø95x140mm	20

Cristal

SERIE



Bombilla LED cristal

Material: **cristal**. Uso interior.

Referencia	Artículo	Tipo	Potencia	Lúmenes	Casquillo	Luz	Dimensión	Embalaje
200690066	A	Esférica	4W	470Lm	E14	● 3000K	Ø45x80mm	10/50
200690078 ★	A	Esférica	4W	470Lm	E14	● 4000K	Ø45x80mm	10/50
200690067	A	Esférica	4W	470Lm	E14	● 6500K	Ø45x80mm	10/50
200690068	B	Esférica	6W	806Lm	E27	● 3000K	Ø45x80mm	10/50
200690079 ★	B	Esférica	6W	806Lm	E27	● 4000K	Ø45x80mm	10/50
200690069	B	Esférica	6W	806Lm	E27	● 6500K	Ø45x80mm	10/50
200695042	C	Vela	4W	470Lm	E14	● 3000K	Ø35x98mm	10/50
200695050 ★	C	Vela	4W	470Lm	E14	● 4000K	Ø35x98mm	10/50
200695043	C	Vela	4W	470Lm	E14	● 6500K	Ø35x98mm	10/50
200695044	D	Soplo viento	4W	470Lm	E14	● 3000K	Ø35x118mm	10/100



5W



- 3000K
- 4200K
- 6000K
- E27
- 200°
- 15.000
- ≥80Ra
- 20.000h.
- 220-240V

Bombilla LED estándar

Tipo: A55. Material: **aluminio + PC**. Uso interior.

Referencia	Potencia	Lúmenes	Casquillo	Luz	Dimensión	Embalaje
200601028	5W	470Lm	E27	3000K	Ø55x104mm	10/100
200601029	5W	470Lm	E27	4200K	Ø55x104mm	10/100
200601030	5W	470Lm	E27	6000K	Ø55x104mm	10/100



8.5W



- 3000K
- 4200K
- 6000K
- E27
- 200°
- 15.000
- ≥80Ra
- 20.000h.
- 220-240V

Bombilla LED estándar

Tipo: A60. Material: **aluminio + PC**. Uso interior.

Referencia	Potencia	Lúmenes	Casquillo	Luz	Dimensión	Embalaje
200601031	8.5W	806Lm	E27	3000K	Ø60x108mm	10/100
200601032	8.5W	806Lm	E27	4200K	Ø60x108mm	10/100
200601033	8.5W	806Lm	E27	6000K	Ø60x108mm	10/100



11W



- 3000K
- 4200K
- 6000K
- E27
- 200°
- 15.000
- ≥80Ra
- 25.000h.
- 170-250V

Bombilla LED estándar

Tipo: A60. Uso interior.

Referencia	Potencia	Lúmenes	Casquillo	Luz	Dimensión	Embalaje
200601034	11W	1060Lm	E27	3000K	Ø60x107mm	10/100
200601035	11W	1060Lm	E27	4200K	Ø60x107mm	10/100
200601036	11W	1060Lm	E27	6000K	Ø60x107mm	10/100



11W



- 3000K
- 6000K
- E27
- 240°
- 15.000
- ≥80Ra
- 25.000h.
- 170-250V

Bomb. LED estándar regulable

Tipo: A60. Uso interior. **Regulación TRIAC.** Regulable en intensidad.

Referencia	Potencia	Lúmenes	Casquillo	Luz	Dimensión	Embalaje
200601049	11W	1200Lm	E27	3000K	Ø60x107mm	10/100
200601050	11W	1200Lm	E27	6000K	Ø60x107mm	10/100



13W



- 3000K
- 4200K
- 6000K
- E27
- 200°
- 15.000
- ≥80Ra
- 25.000h.
- 170-250V

Bombilla LED estándar

Tipo: A60. Uso interior.

Referencia	Potencia	Lúmenes	Casquillo	Luz	Dimensión	Embalaje
200601037	13W	1256Lm	E27	3000K	Ø60x118mm	10/100
200601038	13W	1256Lm	E27	4200K	Ø60x118mm	10/100
200601039	13W	1256Lm	E27	6000K	Ø60x118mm	10/100



15W



- 3000K
- 4200K
- 6000K
- E27
- 190°
- 15.000
- ≥80Ra
- 25.000h.
- 170-250V

Bombilla LED estándar

Tipo: A60. Material: **aluminio + PC**. Uso interior.

Referencia	Potencia	Lúmenes	Casquillo	Luz	Dimensión	Embalaje
200601040	15W	1574Lm	E27	3000K	Ø60x118mm	10/100
200601041	15W	1574Lm	E27	4200K	Ø60x118mm	10/100
200601042	15W	1574Lm	E27	6000K	Ø60x118mm	10/100



18W



- 3000K
- 4200K
- 6000K
- E27
- 200°
- 15.000
- ≥80Ra
- 25.000h.
- 175-265V

Bombilla LED estándar

Tipo: A65. Material: **aluminio + PC**. Uso interior.

Referencia	Potencia	Lúmenes	Casquillo	Luz	Dimensión	Embalaje
200601007	18W	1800Lm	E27	3000K	Ø65x134mm	10/100
200601008	18W	1800Lm	E27	4200K	Ø65x134mm	10/100
200601009	18W	1800Lm	E27	6000K	Ø65x134mm	10/100



21W



- 3000K
- 4200K
- 6000K
- E27
- 200°
- 15.000
- ≥80Ra
- 25.000h.
- 175-265V

Bombilla LED estándar

Tipo: A65. Material: **aluminio + PC**. Uso interior.

Referencia	Potencia	Lúmenes	Casquillo	Luz	Dimensión	Embalaje
200601010	21W	2350Lm	E27	3000K	Ø70x159mm	10/100
200601011	21W	2350Lm	E27	4200K	Ø70x159mm	10/100
200601012	21W	2350Lm	E27	6000K	Ø70x159mm	10/100

Esféricas

BOMBILLAS

Bombillas, tubos y campanas Bombillas LED



Bombilla LED esférica

-  3000K
-  4200K
-  6000K
-  E14
-  180°
-  15.000
-  ≥80Ra
-  20.000h.
-  220-240V

Tipo: G45. Uso interior.

Referencia	Potencia	Lúmenes	Casquillo	Luz	Dimensión (AxB)	Embalaje
200690024	3W	250Lm	E14	 3000K	Ø45x79mm	10/100
200690025	3W	250Lm	E14	 4200K	Ø45x79mm	10/100
200690026	3W	250Lm	E14	 6000K	Ø45x79mm	10/100
200690030	5W	470Lm	E14	 3000K	Ø45x79mm	10/100
200690031	5W	470Lm	E14	 4200K	Ø45x79mm	10/100
200690032	5W	470Lm	E14	 6000K	Ø45x79mm	10/100
200690036	6.5W	600Lm	E14	 3000K	Ø45x79mm	10/100
200690037	6.5W	600Lm	E14	 4200K	Ø45x79mm	10/100
200690038	6.5W	600Lm	E14	 6000K	Ø45x79mm	10/100

Esféricas

BOMBILLAS



Bombilla LED esférica

- 3000K
- 4200K
- 6000K
- E14
- 200°
- 15.000
- ≥80Ra
- 25.000h.
- 175-265V

Tipo: G45. Uso interior.

Referencia	Potencia	Lúmenes	Casquillo	Luz	Dimensión	Embalaje
200690018	7.5W	650Lm	E14	3000K	Ø45x84mm	10/100
200690019	7.5W	650Lm	E14	4200K	Ø45x84mm	10/100
200690020	7.5W	650Lm	E14	6000K	Ø45x84mm	10/100



Bombilla LED esférica

- 3000K
- 4200K
- 6000K
- E14
- 180°
- 15.000
- ≥80Ra
- 20.000h.
- 220-240V

Tipo: G45. Uso interior.

Referencia	Potencia	Lúmenes	Casquillo	Luz	Dimensión	Embalaje
200690042	8.5W	806Lm	E14	3000K	Ø45x88mm	10/100
200690043	8.5W	806Lm	E14	4200K	Ø45x88mm	10/100
200690044	8.5W	806Lm	E14	6000K	Ø45x88mm	10/100



Bombillas, tubos y campanas Bombillas LED



Bombilla LED esférica

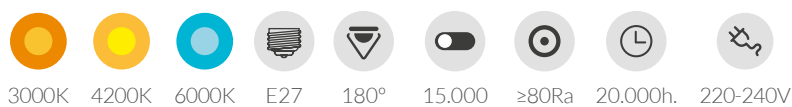

Tipo: G45. Uso interior.



Referencia	Potencia	Lúmenes	Casquillo	Luz	Dimensión	Embalaje
200690027	3W	250Lm	E27	● 3000K	Ø45x79mm	10/100
200690028	3W	250Lm	E27	● 4200K	Ø45x79mm	10/100
200690029	3W	250Lm	E27	● 6000K	Ø45x79mm	10/100
200690033	5W	470Lm	E27	● 3000K	Ø45x79mm	10/100
200690034	5W	470Lm	E27	● 4200K	Ø45x79mm	10/100
200690035	5W	470Lm	E27	● 6000K	Ø45x79mm	10/100
200690039	6.5W	600Lm	E27	● 3000K	Ø45x79mm	10/100
200690040	6.5W	600Lm	E27	● 4200K	Ø45x79mm	10/100
200690041	6.5W	600Lm	E27	● 6000K	Ø45x79mm	10/100



Bombilla LED esférica









-  3000K
-  4200K
-  6000K
-  E27
-  200°
-  15.000
-  ≥80Ra
-  25.000h.
-  175-265V

Tipo: G45. Uso interior.



Referencia	Potencia	Lúmenes	Casquillo	Luz	Dimensión	Embalaje
200690021	7.5W	700Lm	E27	 3000K	Ø45x81mm	10/100
200690022	7.5W	700Lm	E27	 4200K	Ø45x81mm	10/100
200690023	7.5W	700Lm	E27	 6000K	Ø45x81mm	10/100



Bombilla LED esférica

-  3000K
-  4200K
-  6000K
-  E27
-  180°
-  15.000
-  ≥80Ra
-  20.000h.
-  220-240V

Tipo: G45. Uso interior.

Referencia	Potencia	Lúmenes	Casquillo	Luz	Dimensión	Embalaje
200690045	8.5W	806Lm	E27	 3000K	Ø45x88mm	10/100
200690046	8.5W	806Lm	E27	 4200K	Ø45x88mm	10/100
200690047	8.5W	806Lm	E27	 6000K	Ø45x88mm	10/100





Velas

BOMBILLAS



Bombillas, tubos y campanas Bombillas LED



-  3000K
-  4200K
-  6000K
-  E14
-  180°
-  15.000
-  ≥80Ra
-  20.000h.
-  220-240V

Bombilla LED vela

Tipo: C37. Uso interior.

Referencia	Potencia	Lúmenes	Casquillo	Luz	Dimensión (AxB)	Embalaje
200695012	3W	250Lm	E14	 3000K	Ø37x100mm	10/100
200695013	3W	250Lm	E14	 4200K	Ø37x100mm	10/100
200695014	3W	250Lm	E14	 6000K	Ø37x100mm	10/100
200695015	5W	470Lm	E14	 3000K	Ø37x100mm	10/100
200695016	5W	470Lm	E14	 4200K	Ø37x100mm	10/100
200695017	5W	470Lm	E14	 6000K	Ø37x100mm	10/100
200695018	6.5W	600Lm	E14	 3000K	Ø36.5x100mm	10/100
200695019	6.5W	600Lm	E14	 4200K	Ø36.5x100mm	10/100
200695020	6.5W	600Lm	E14	 6000K	Ø36.5x100mm	10/100



Bombilla LED vela

- 3000K
- 4200K
- 6000K
- E14
- 200°
- 15.000
- ≥80Ra
- 25.000h.
- 175-265V

Tipo: C37. Uso interior.

Referencia	Potencia	Lúmenes	Casquillo	Luz	Dimensión	Embalaje
200695009	7.5W	700Lm	E14	3000K	Ø37x102mm	10/100
200695010	7.5W	700Lm	E14	4200K	Ø37x102mm	10/100
200695011	7.5W	700Lm	E14	6000K	Ø37x102mm	10/100



Bombilla LED vela

- 3000K
- 4200K
- 6000K
- E14
- 180°
- 15.000
- ≥80Ra
- 20.000h.
- 220-240V

Tipo: C37. Uso interior.

Referencia	Potencia	Lúmenes	Casquillo	Luz	Dimensión	Embalaje
200695021	8.5W	806Lm	E14	3000K	Ø38x106mm	10/100
200695022	8.5W	806Lm	E14	4200K	Ø38x106mm	10/100
200695023	8.5W	806Lm	E14	6000K	Ø38x106mm	10/100



6.5W



- 3000K
- 6000K
- E27
- 180°
- 15.000
- ≥80Ra
- 20.000h.
- 220-240V

Bombilla LED vela

Tipo: C37. Uso interior.

Referencia	Potencia	Lúmenes	Casquillo	Luz	Dimensión (AxB)	Embalaje
200695024	6.5W	600Lm	E27	3000K	Ø37x107mm	10/100
200695025	6.5W	600Lm	E27	6000K	Ø37x107mm	10/100



6.5W



- 3000K
- E14
- 180°
- 15.000
- ≥80Ra
- 20.000h.
- 220-240V

Bombilla LED vela sopló viento

Tipo: C37. Uso interior.

Referencia	Potencia	Lúmenes	Casquillo	Luz	Dimensión (AxB)	Embalaje
200695026	6.5W	600Lm	E14	3000K	Ø37x124mm	10/100



Bombilla LED con sensor



Tipo: A60. Uso interior.

Referencia	Artículo	Potencia	Lúmenes	Casquillo	Luz	Dimensión	Embalaje
200680000	A	9W	950Lm	E27	3000K	Ø60x112mm	10/100
200680001	A	9W	950Lm	E27	6000K	Ø60x112mm	10/100
200680002	B	9W	950Lm	E27	3000K	Ø60x112mm	10/100
200680003	B	9W	950Lm	E27	6000K	Ø60x112mm	10/100
200680004	C	9W	950Lm	E27	3000K	Ø60x112mm	10/100
200680005	C	9W	950Lm	E27	6000K	Ø60x112mm	10/100



Voltaje ESPECIAL



A

B

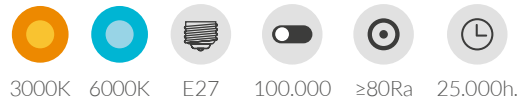

Bombilla LED estándar

Uso interior. AC/DC 12-24V.

Referencia	Artículo	Tipo	Potencia	Lúmenes	Casquillo	Luz	Dimensión	Embalaje
200685002	A	Estándar	9W	924Lm	E27	3000K	Ø60x112mm	10/100
200685003	A	Estándar	9W	924Lm	E27	6000K	Ø60x112mm	10/100
200685006	B	Esférica	5W	485Lm	E27	3000K	Ø45x81mm	10/100
200685007	B	Esférica	5W	485Lm	E27	6000K	Ø45x81mm	10/100

Globo BOMBILLAS



A

B

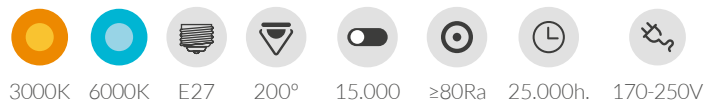

Bombilla LED globo

Tipo: globo. Uso interior.

Referencia	Artículo	Tipo	Potencia	Lúmenes	Casquillo	Luz	Dimensión	Embalaje
200626006	A	G95	15W	1700Lm	E27	3000K	Ø95x146mm	10/50
200626007	A	G95	15W	1700Lm	E27	6000K	Ø95x146mm	10/50
200626008	B	G120	18W	2000Lm	E27	3000K	Ø120x156mm	5/50
200626009	B	G120	18W	2000Lm	E27	6000K	Ø120x156mm	5/50

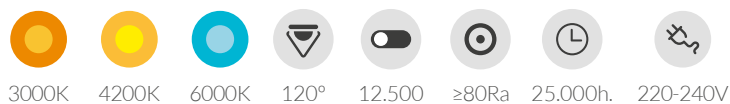

Bombilla LED reflectora

Tipo: reflectora. Uso interior.

Referencia	Artículo	Tipo	Potencia	Lúmenes	Casquillo	Luz	Dimensión	Embalaje
200616000	A	R39	5W	430Lm	E14	3000K	Ø39x68mm	10/100
200616001	A	R39	5W	430Lm	E14	4200K	Ø39x68mm	10/100
200616002	A	R39	5W	430Lm	E14	6000K	Ø39x68mm	10/100
200616003	B	R50	7W	630Lm	E14	3000K	Ø50x54mm	10/100
200616004	B	R50	7W	630Lm	E14	4200K	Ø50x54mm	10/100
200616005	B	R50	7W	630Lm	E14	6000K	Ø50x54mm	10/100
200616006	C	R63	9W	860Lm	E27	3000K	Ø63x103mm	10/50
200616007	C	R63	9W	860Lm	E27	4200K	Ø63x103mm	10/50
200616008	C	R63	9W	860Lm	E27	6000K	Ø63x103mm	10/50
200616009	D	R80	12W	1200Lm	E27	3000K	Ø80x113mm	10/50
200616010	D	R80	12W	1200Lm	E27	4200K	Ø80x113mm	10/50
200616011	D	R80	12W	1200Lm	E27	6000K	Ø80x113mm	10/50
200616012	E	R90	15W	1490Lm	E27	3000K	Ø90x114mm	10/50
200616013	E	R90	15W	1490Lm	E27	4200K	Ø90x114mm	10/50
200616014	E	R90	15W	1490Lm	E27	6000K	Ø90x114mm	10/50



12W



Bomb. LED PAR30

- 3000K
- 4200K
- 6000K
- E27
- 120°
- 15.000
- ≥80Ra
- 25.000h.
- IP65
- 170-250V

Tipo: **PAR30**. Uso exterior.

Referencia	Potencia	Lúmenes	Casquillo	Luz	Dimensión	Embalaje
200620019	12W	1450Lm	E27	3000K	Ø95x103mm	40
200620020	12W	1450Lm	E27	6000K	Ø95x103mm	40



18W



Bomb. LED PAR38

- 3000K
- 4000K
- 6000K
- E27
- 120°
- 15.000
- ≥80Ra
- 25.000h.
- IP65
- 170-250V

Tipo: **PAR38**. Uso exterior.

Referencia	Potencia	Lúmenes	Casquillo	Luz	Dimensión	Embalaje
200620021	18W	2070Lm	E27	3000K	Ø120x133mm	30
200620022	18W	2070Lm	E27	4000K	Ø120x133mm	30
200620023	18W	2070Lm	E27	6000K	Ø120x133mm	30

Par38

BOMBILLAS



Bombilla LED PAR38



Tipo: **PAR38**. Uso exterior.

Referencia	Potencia	Casquillo	Luz	Dimensión	Embalaje
200620024	15W	E27	● Azul	Ø121x132mm	30
200620025	15W	E27	● Rojo	Ø121x132mm	30
200620026	15W	E27	● Amarillo	Ø121x132mm	30
200620027	15W	E27	● Verde	Ø121x132mm	30





Bombilla LED cornlight

Tipo: **cornlight**. Ideal para **downlights**. Uso interior.

Referencia	Artículo	Potencia	Lúmenes	Casquillo	Luz	Dimensión	Embalaje
200600001	A	7W	800Lm	E27	● 4200K	Ø45x100mm	10/200
200600003	A	7W	800Lm	E27	● 6000K	Ø45x100mm	10/200
200600004	B	9W	1000Lm	E27	● 4200K	Ø45x147mm	10/100
200600005	B	9W	1000Lm	E27	● 6000K	Ø45x147mm	10/100

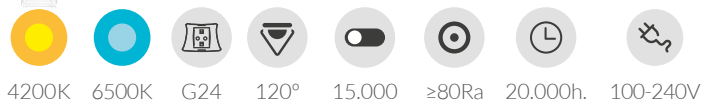

Bombilla LED PL

Tipo: **PL**. LED SMD. Ideal para **downlights**. Uso interior.

Referencia	Potencia	Lúmenes	Casquillo	Luz	Dimensión	Embalaje
200630001	11.4W	980Lm	G24	● 4200K	Ø35x165mm	25/100
200630002	11.4W	980Lm	G24	● 6500K	Ø35x165mm	25/100



- 4000K
- 6500K
- G24
- 120°
- 15.000
- ≥80Ra
- 15.000h.
- 220-240V

Bombilla LED PL

Tipo: **PL**. LED SMD. Ideal para **downlights**. Uso interior.

Referencia	Potencia	Lúmenes	Casquillo	Luz	Dimensión	Embalaje
200630019	9W	850Lm	G24	4000K	Ø28x162mm	100
200630020	9W	850Lm	G24	6500K	Ø28x162mm	100

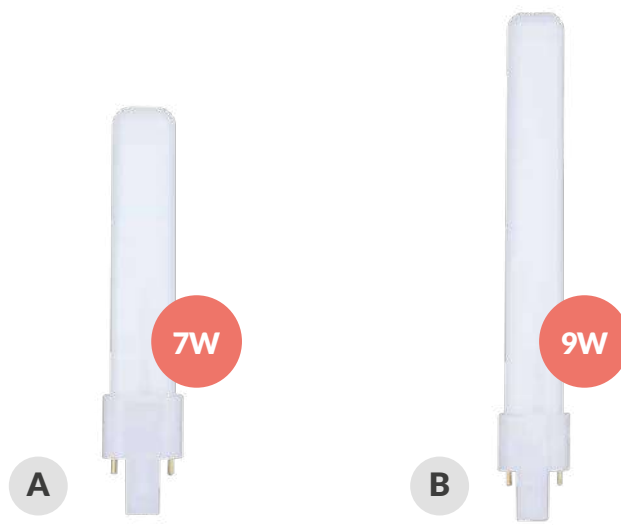

- 4200K
- 6000K
- G23
- 220°
- >15.000
- ≥80Ra
- 15.000h.
- 220-240V

Bombilla LED PL

Tipo: **PL**. Uso interior.



Referencia	Artículo	Potencia	Lúmenes	Casquillo	Luz	Dimensión	Embalaje
200630014	A	7W	620Lm	G23	4200K	Ø32x164mm	50
200630015	A	7W	620Lm	G23	6000K	Ø32x164mm	50
200630016	B	9W	840Lm	G23	4200K	Ø32x232mm	50
200630017	B	9W	840Lm	G23	6000K	Ø32x232mm	50

* Consulta el conexionado en el apartado info técnica.

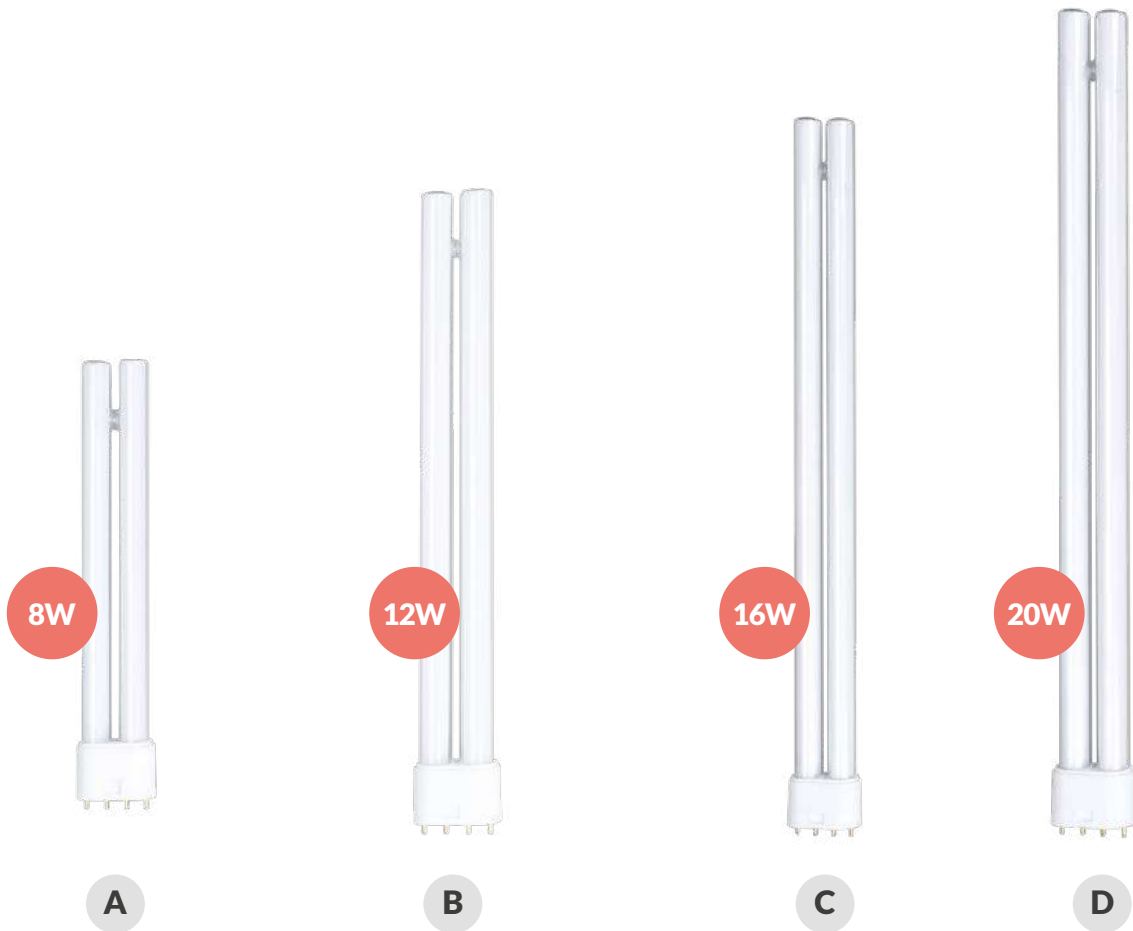



Bombilla LED PL

-  4200K
-  2G11
-  360°
-  100.000
-  ≥80Ra
-  25.000h.
-  175-265V

Tipo: **PL**. Sustituye a las PL tradicionales. Tubo: Ø17mm. Uso interior.

Referencia	Artículo	Potencia	Lúmenes	Casquillo	Luz	Dimensión	Embalaje
200630003	A	8W	820Lm	2G11	● 4200K	43x225mm	50
200630004	B	12W	1318Lm	2G11	● 4200K	43x320mm	50
200630005	C	16W	1950Lm	2G11	● 4200K	43x415mm	50
200630006	D	20W	2500Lm	2G11	● 4200K	43x542mm	50



Bombilla LED R7s

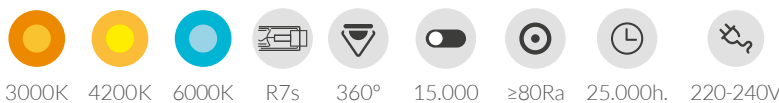

Tipo: **lineal**. LED SMD. Uso interior. No regulable.

Referencia	Potencia	Lúmenes	Casquillo	Luz	Dimensión	Embalaje
200650027	5.5W	620Lm	R7s	3000K	Ø15x78mm	100/400
200650028	5.5W	620Lm	R7s	4200K	Ø15x78mm	100/400
200650029	5.5W	620Lm	R7s	6000K	Ø15x78mm	100/400
200650030	9W	930Lm	R7s	3000K	Ø15x118mm	100/400
200650031	9W	930Lm	R7s	4200K	Ø15x118mm	100/400
200650032	9W	930Lm	R7s	6000K	Ø15x118mm	100/400



Bombilla LED R7s

- 3000K
- 4000K
- 6000K
- R7s
- 330°
- 50.000
- ≥80Ra
- 15.000h.
- 175-250V

Tipo: **lineal**. LED SMD. Material: **aluminio + PC**. Uso interior. Regulables las de 13W.

Referencia	Potencia	Lúmenes	Casquillo	Luz	Dimensión	Embalaje
200650048	13W	1550Lm	R7s	3000K	Ø29x118mm	10/100
200650049	13W	1550Lm	R7s	4000K	Ø29x118mm	10/100
200650050	13W	1550Lm	R7s	6000K	Ø29x118mm	10/100
200650045	16W	2100Lm	R7s	3000K	Ø29x118mm	10/100
200650046	16W	2100Lm	R7s	4000K	Ø29x118mm	10/100
200650047	16W	2100Lm	R7s	6000K	Ø29x118mm	10/100



Bombilla LED R7s

-
-
-
-
-
-
-
-
-

Tipo: **lineal**. LED COB. Uso interior. No regulable.

Referencia	Potencia	Lúmenes	Casquillo	Luz	Dimensión	Embalaje
200650051	4.5W	480Lm	R7s	3000K	Ø15x78mm	100/200
200650052	4.5W	480Lm	R7s	4200K	Ø15x78mm	100/200
200650053	4.5W	480Lm	R7s	6000K	Ø15x78mm	100/200
200650054	9W	1100Lm	R7s	3000K	Ø15x118mm	100/200
200650055	9W	1100Lm	R7s	4200K	Ø15x118mm	100/200
200650056	9W	1100Lm	R7s	6000K	Ø15x118mm	100/200

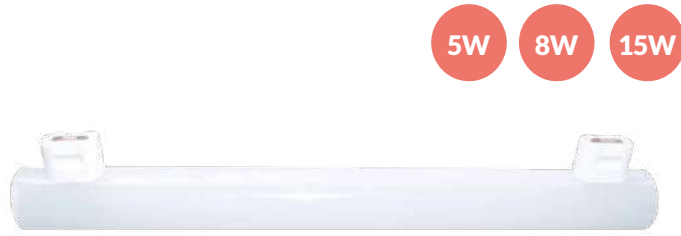

A



B



- 2700K
- S14s
- 270°
- 12.500
- ≥80Ra
- 25.000h.
- IP20
- 230V

Linestra LED

Ideal para baños.

Referencia	Potencia	Lúmenes	Casquillo	Luz	Longitud	Embalaje
200615004	5W	500Lm	S14s	● 2700K	300mm	10/50
200615005	8W	750Lm	S14s	● 2700K	500mm	10/50
200615006	15W	1550Lm	S14s	● 2700K	1000mm	10/50
200615001	5W	450Lm	S14d	● 2700K	300mm	10/50
200615002	8W	750Lm	S14d	● 2700K	500mm	10/50

* Consulta el conexionado en el apartado info técnica.



Bombilla LED sofito

- 4200K
- 6000K
- S19
- 180°
- 15.000
- ≥80Ra
- 20.000h.
- 220-240V

Material: PC. Uso interior.

Referencia	Potencia	Lúmenes	Casquillo	Luz	Dimensión	Embalaje
200640001	9W	850Lm	S19	4200K	Ø38x310mm	70
200640002	9W	850Lm	S19	6000K	Ø38x310mm	70



- 12W
- 20W
- 24W

Placa LED con imán para plafones

- 6500K
- 155°
- 15.000
- ≥80Ra
- 25.000h.
- IP20
- 170-250V
- Hz

Funciona sin transformadores ni cebadores.

Referencia	Potencia	Lúmenes	Luz	Dimensión	Embalaje
200635003	12W	1300Lm	6500K	Ø125x30mm	100
200635004	20W	2100Lm	6500K	Ø185x24mm	100
200635005	24W	2500Lm	6500K	Ø180x25mm	100





6W / 8W / 13W / 14W



28W



Tubo fluorescente T5 trifósforo

Uso interior.

Referencia	Potencia	Lúmenes	Casquillo	Luz	Longitud	Embalaje
002001178	6W	320Lm	G5	● 4200K	226mm	50/500
002005120	6W	320Lm	G5	● 6400K	226mm	50/500
002001179	8W	440Lm	G5	● 4200K	302mm	50/500
002005121	8W	440Lm	G5	● 6400K	302mm	50/500
002001180	13W	980Lm	G5	● 4200K	534mm	25/100
002005123	14W	1180Lm	G5	● 6400K	563mm	25/100
002001183	28W	2585Lm	G5	● 4200K	1163mm	25/100



15W / 18W



58W



4200K



6400K



15.000h.



230V



50Hz

Tubo fluorescente T8 trifósforo

Uso interior.

Referencia	Potencia	Lúmenes	Casquillo	Luz	Longitud	Embalaje
002000468	15W	900Lm	G13	● 6400K	450mm	25
002003475	18W	1350Lm	G13	● 4200K	600mm	25
002000588	58W	5000Lm	G13	● 6400K	1500mm	25



6400K



360°



7.500



15.000h.



220-240V

Tubo fluorescente circular T9 trifósforo

Tipo: **trifósforo**. Casquillo: **G10q**. Uso interior. IP20.

Referencia	Potencia	Lúmenes	Dimensión	Emb.
200800007	22W	1150Lm	Ø216x32mm	20
200800009	32W	1950Lm	Ø305x32mm	20
200800011	40W	2600Lm	Ø406x32mm	20



15.000h.



230V

Cebador universal

Para tubos fluorescentes

Referencia	Potencia	Embalaje
002000592	15W / 22W	25/500
002000593	4W / 65W	25/500



A



60 cm
3000K 4200K 6000K

B



120 cm
3000K 4200K 6000K

C



150 cm
4200K 6000K



G13 160° 15.500 ≥80Ra 30.000h. 176-265V

Tubo T8 LED

Tipo: **translúcido**. Material: **plástico**. Incluyen cebador. Pueden ir directos a 230V (175-250V). **Con reactancia magnética**, se sustituye el cebador y se reemplaza el tubo directamente.

Referencia	Artículo	Potencia	Lúmenes	Casquillo	Luz	Dimensión	Embalaje
200815021	A	9W	1060Lm	G13	3000K	Ø26x600mm	25
200815022	A	9W	1060Lm	G13	4200K	Ø26x600mm	25
200815023	A	9W	1060Lm	G13	6000K	Ø26x600mm	25
200815024	B	18W	2100Lm	G13	3000K	Ø26x1200mm	25
200815025	B	18W	2100Lm	G13	4200K	Ø26x1200mm	25
200815026	B	18W	2100Lm	G13	6000K	Ø26x1200mm	25
200815027	C	24W	2700Lm	G13	4200K	Ø26x1500mm	25
200815028	C	24W	2700Lm	G13	6000K	Ø26x1500mm	25



60 cm
4000K 6500K



120 cm
4000K 6500K



150 cm
4000K 6500K



G13
 200°
 12.500
 ≥80Ra
 25.000h
 176-264V

Tubo T8 LED cristal





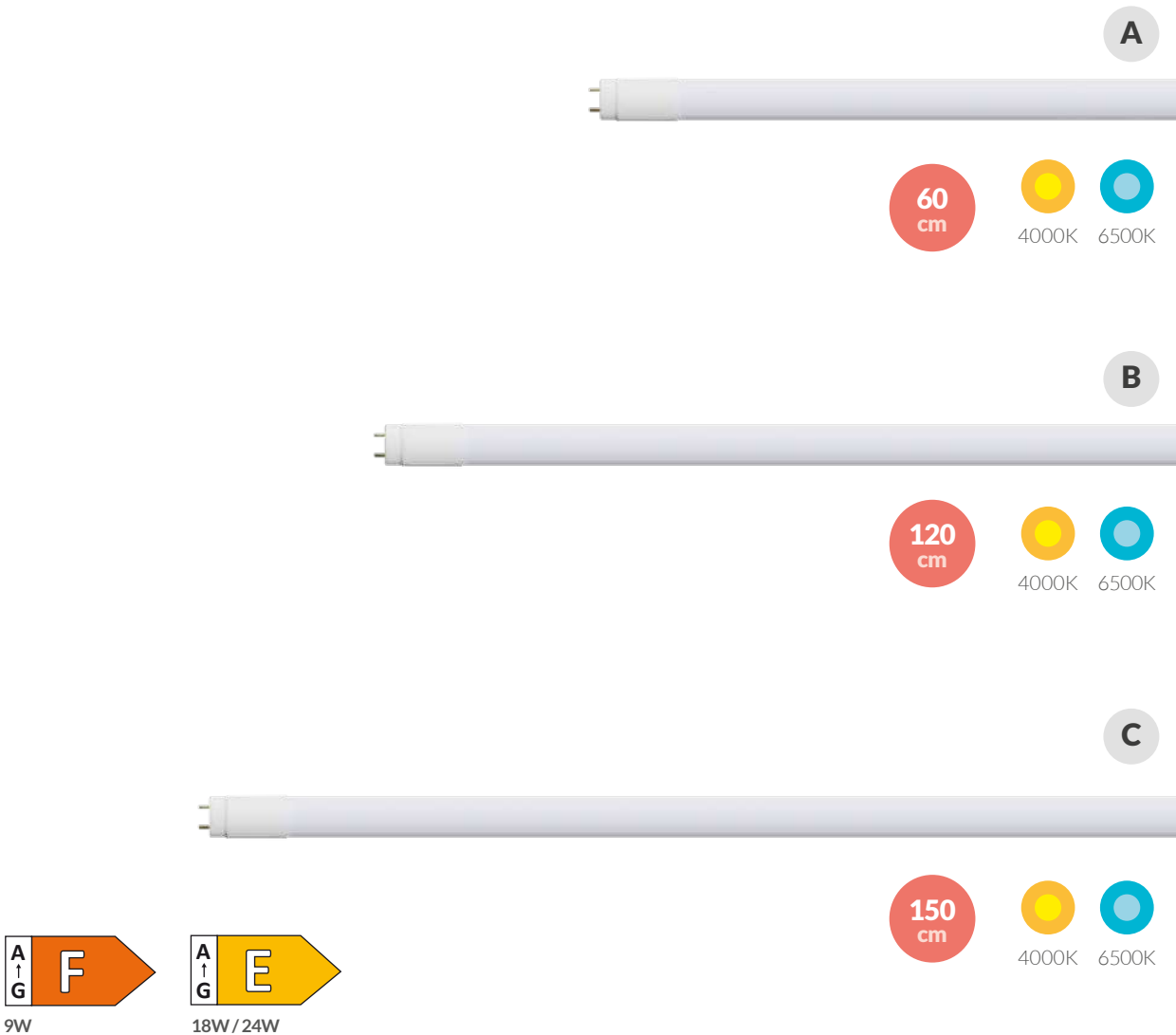

Material: **crystal**. Incluyen cebador. Pueden ir directos a 230V (176-264V).
Con reactancia magnética, se sustituye el cebador y se reemplaza el tubo directamente.

Referencia	Artículo	Potencia	Lúmenes	Casquillo	Luz	Dimensión	Embalaje
200815015	A	9W	1170Lm	G13	● 4000K	Ø26x600mm	25
200815016	A	9W	1170Lm	G13	● 6500K	Ø26x600mm	25
200815017	B	18W	2340Lm	G13	● 4000K	Ø26x1200mm	25
200815018	B	18W	2340Lm	G13	● 6500K	Ø26x1200mm	25
200815019	C	22W	2860Lm	G13	● 4000K	Ø26x1500mm	25
200815020	C	22W	2860Lm	G13	● 6500K	Ø26x1500mm	25



Bombillas, tubos y campanas Tubos LED

Tubo T8 LED cristal

-  G13
-  220°
-  12.500
-  PF≥0.9
-  ≥80Ra
-  25.000h.
-  220-240V

Material: **crystal**. Incluyen cebador. Pueden ir directos a 230V (175-250V).
Con reactancia magnética, se sustituye el cebador y se reemplaza el tubo directamente.

Referencia	Artículo	Potencia	Lúmenes	Casquillo	Luz	Dimensión	Embalaje
200815009	A	9W	900Lm	G13	● 4000K	Ø26x600mm	25
200815010	A	9W	900Lm	G13	● 6500K	Ø26x600mm	25
200815011	B	18W	2000Lm	G13	● 4000K	Ø26x1200mm	25
200815012	B	18W	2000Lm	G13	● 6500K	Ø26x1200mm	25
200815013	C	24W	2640Lm	G13	● 4000K	Ø26x1500mm	25
200815014	C	24W	2640Lm	G13	● 6500K	Ø26x1500mm	25



6000K



G13



180°



100.000



≥80Ra



50.000h.



85-265V

Tubo T8 LED

Incluyen cebador. Directo a 230V (100-250V). Material: PC + aluminio. Alto rendimiento 140Lm/W.
Con reactancia magnética, se sustituye el cebador y se reemplaza el tubo directamente.

Referencia	Potencia	Lúmenes	Casquillo	Luz	Dimensión	Embalaje
200815005	10W	1400Lm	G13	● 6000K	Ø26x600mm	25
200815006	18W	2520Lm	G13	● 6000K	Ø26x1200mm	25
200815007	24W	3360Lm	G13	● 6000K	Ø26x1500mm	25

Lisala

TUBO CRICULAR



15W

20W

30W



6500K



G10q



120°



>15.000



≥80Ra



15.000h.



220-240V

Tubo circular LED

Tipo: **translúcido**. Funciona sin transformadores ni cebadores.

Referencia	Potencia	Lúmenes	Casquillo	Luz	Dimensión	Embalaje
200800001	15W	1500Lm	G10q	● 6500K	Ø215x30mm	10
200800003	20W	2080Lm	G10q	● 6500K	Ø300x30mm	10
200800004	30W	3200Lm	G10q	● 6500K	Ø400x30mm	10

* Consulta el conexionado en el apartado info técnica.

Bikoro
INDUSTRIAL

Bombillas, tubos y campanas Bombillas industriales



33W

42W



5000K



E27



220°



50.000



≥80Ra



20.000h.



IP20



220-240V



50Hz

Bombilla LED industrial

Ideal para sustituir bombillas industriales tradicionales.

Referencia	Potencia	Lúmenes	Casquillo	Luz	Dimensión	Embalaje
200610010	33W	3600Lm	E27	● 5000K	Ø100x159mm	8
200610011	42W	4500Lm	E27	● 5000K	Ø186x118mm	8

Boldy
INDUSTRIAL



E40



5000K



E40



120°



25.000



≥80Ra



50.000h.



IP20



220-240V



50/60Hz

Bombilla LED para campana industrial

Tipo: **V1**. Ideal para sustituir bombillas industriales tradicionales.

Referencia	Potencia	Lúmenes	Casquillo	Luz	Dimensión	Embalaje
200610008	95W	13.550Lm	E40	● 5000K	Ø190x275mm	4
200610009	140W	19.550Lm	E40	● 5000K	Ø230x306mm	4



Bombillas, tubos y campanas Bombillas industriales



Oihana

INDUSTRIAL



- E27
- E40
- 30W
- 40W
- 50W



- 5000K
- 340°
- 50.000
- ≥80Ra
- 20.000h.
- IP20
- 220-240V
- 50/60Hz

Bombilla LED para campana industrial

Ideal para sustituir bombillas industriales tradicionales.

Referencia	Potencia	Lúmenes	Casquillo	Luz	Dimensión	Embalaje
200610004	30W	3320Lm	E27	● 5000K	Ø96x228mm	20
200610005	40W	4660Lm	E27	● 5000K	Ø108x246mm	20
200610006	50W	5500Lm	E27	● 5000K	Ø108x264mm	20
200610007	50W	5500Lm	E40	● 5000K	Ø108x264mm	20

Titas
INDUSTRIAL

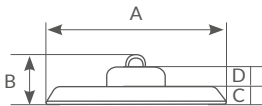

- 4000K
- 5000K
- 6500K
- 90°
- 30.000
- ≥80Ra
- 35.000h.
- IP65
- 185-265V
- Hz

Campana industrial LED

Material: **aluminio + PC. IK09.**

Referencia	Potencia	Lúmenes útiles (90°)	Lúmenes nominales (360°)	Luz	Dimensión (AxBxCxD)	Embalaje
202400006	100W	12.000Lm	13.000Lm	4000K	Ø250x97.2x30x32mm	1
202400007	100W	12.000Lm	13.000Lm	5000K	Ø250x97.2x30x32mm	1
202400008	100W	12.000Lm	13.000Lm	6500K	Ø250x97.2x30x32mm	1
202400009	150W	18.000Lm	19.500Lm	4000K	Ø295x97.7x35x27.5mm	1
202400010	150W	18.000Lm	19.500Lm	5000K	Ø295x97.7x35x27.5mm	1
202400011	150W	18.000Lm	19.500Lm	6500K	Ø295x97.7x35x27.5mm	1
202400012	200W	24.000Lm	26.000Lm	4000K	Ø320x98.2x39x23.5mm	1
202400013	200W	24.000Lm	26.000Lm	5000K	Ø320x98.2x39x23.5mm	1
202400014	200W	24.000Lm	26.000Lm	6500K	Ø320x98.2x39x23.5mm	1

Bombillas, tubos y campanas Campanas y farolas ind.

Mitope
INDUSTRIAL



Bombillas, tubos y campanas Campanas y farolas ind.



Ajustable en temperatura y potencia



Incluye conector Zhaga para sensor

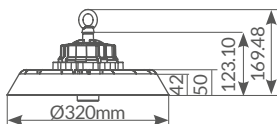

Soporte para campana
Se vende por separado



Mando para sensor
Se vende por separado

- 100.000
- ≥70Ra
- 50.000h.
- IP65
- 100-277V
- 50/60Hz

Campana industrial LED

Ajustable en temperatura y potencia. Incluye conector Zhaga para sensor. Material: aluminio + PC.IK10.

Referencia	Potencia	Lúmenes	Ángulo apertura	Luz	Embalaje
202400016	120-160-200W	Máx. 160Lm/W	90°	3000-4000-5700K	1
202415001	Sensor microondas Zhaga para campana Mitope				
202415002	Mando para sensor microondas Zhaga				
202415003	Soporte para campana Mitope				
202415004	Óptica 60° para campana Mitope				
202415005	Óptica 120° para campana Mitope				

Bagura

FAROLAS

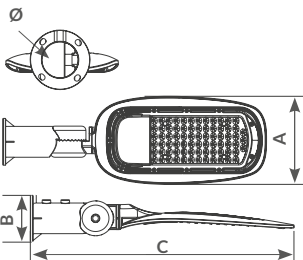

4000K



90° / 130°



15.000



≥80Ra



35.000h.



IP65



220-240V



50/60Hz

Farola LED

Material: **aluminio + PC**. Cable: 300mm. Color: gris. **IK07**.

Referencia	Potencia	Lúmenes útiles (120°)	Lúmenes nominales (360°)	Luz	Dimensión (AxBxCxØ)	Embalaje
201605010	50W	4.900Lm	5.500Lm	● 4000K	152x77x411x60mm	20
201605011	50W	4.900Lm	5.500Lm	● 5000K	152x77x411x60mm	20
201605012	50W	4.900Lm	5.500Lm	● 6500K	152x77x411x60mm	20
201605013	100W	9.354Lm	11.000Lm	● 4000K	84x186x483.5x60mm	10
201605014	100W	9.354Lm	11.000Lm	● 5000K	84x186x483.5x60mm	10
201605015	100W	9.354Lm	11.000Lm	● 6500K	84x186x483.5x60mm	10
201605016	150W	13.300Lm	16.500Lm	● 4000K	84x212.4x552.8x60mm	10
201605017	150W	13.300Lm	16.500Lm	● 5000K	84x212.4x552.8x60mm	10
201605018	150W	13.300Lm	16.500Lm	● 6500K	84x212.4x552.8x60mm	10



Bombillas, tubos y campanas Campanas y farolas ind.



BRIDGELUX LED

7W ≈ 30W 11.5W ≈ 60W 14.5W ≈ 100W

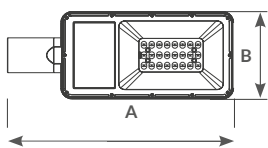
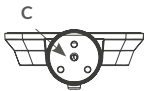

W AxB/C (mm)
 30W 175x451.1/Ø75.4
 60W 200x471.1/Ø75.4
 100W 212x505.0/Ø75.4



4000K



90° / 130°



15.000



≥80Ra



35.000h.



IP65

Farola industrial solar LED

Material: **aluminio + PC**. Cable: 100mm. Color: gris. **Tiempo de carga:** 5-8h.
Autonomía: 7h. en días lluviosos. Voltaje panel solar: 5V. **IK08**.

Referencia	Potencia	Lúmenes	Luz	Panel solar	Panel (mm)	Embalaje
201605004	7W ≈ 30W	1.800Lm	● 4000K	20W 20.000mAh / 4 x 5.000mAh	350x450x17	2
201605005	11.5W ≈ 60W	2.600Lm	● 4000K	30W 30.000mAh / 6 x 5.000mAh	350x600x25	2
201605006	14.5W ≈ 100W	3.200Lm	● 4000K	40W 40.000mAh / 8 x 5.000mAh	670x445x25	4



Tiras LED

Iluminación





- 2700K
- 4000K
- 6000K
- 120°
- ≥80Ra
- 40.000h.
- IP20

Rollo 5M tira LED SMD2835

Flexible, autoadhesiva y fija. 8mm anchura. Uso interior. Incluye adaptador **jack hembra** soldado en un extremo. Alimentación **DC 24V**. 60 LEDs por metro. **Cinta adhesiva 3M**. Es posible cortar por las zonas delimitadas cada 100mm (cada 6 LEDs).

Referencia	Potencia	Lúmenes	Luz	SMD	Embalaje
204030006	6W/M	600Lm/M	2700-3000K	2835	60
204030007	6W/M	600Lm/M	4000-4500K	2835	60
204030008	6W/M	600Lm/M	6000-6500K	2835	60



- 2700K
- 4000K
- 6000K
- 120°
- ≥80Ra
- 40.000h.
- IP20

Rollo 5M tira LED SMD2835

Flexible, autoadhesiva y fija. 8mm anchura. Uso interior. Incluye adaptador **jack hembra** soldado en un extremo. Alimentación **DC 24V**. 120 LEDs por metro. **Cinta adhesiva 3M**. Es posible cortar por las zonas delimitadas cada 50mm.

Referencia	Potencia	Lúmenes	Luz	SMD	Embalaje
204030010	12W/M	1200Lm/M	2700-3000K	2835	60
204030011	12W/M	1200Lm/M	4000-4500K	2835	60
204030012	12W/M	1200Lm/M	6000-6500K	2835	60



Conector hembra

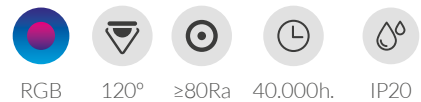

Rollo 5M tira LED SMD5050

Flexible, autoadhesiva. 10mm anchura. Uso interior. Incluye **conector soldado con pines** y **conector hembra**. Alimentación **DC 24V**. **Cinta adhesiva 3M**. Es posible cortar por las zonas delimitadas cada 165mm.

Referencia	Potencia	LED's/M	Corte cada	Luz	SMD	Embalaje
204030009	7.2W/M	30LED's/M	165mm	RGB	5050	50
204030013	14.4W/M	60LED's/M	100mm	RGB	5050	50



IP44

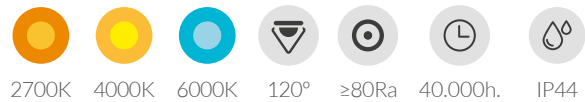

Rollo 5M tira LED SMD2835

Flexible, autoadhesiva y fija. 8mm anchura. Incluye adaptador **jack hembra** soldado en un extremo. Alimentación **DC 24V**. 60 LEDs por metro. **Cinta adhesiva 3M**. Es posible cortar por las zonas delimitadas cada 100mm (cada 6 LEDs).

Referencia	Potencia	Lúmenes	Luz	SMD	Embalaje
204030014	6W/M	600Lm/M	2700-3000K	2835	40
204030015	6W/M	600Lm/M	4000-4500K	2835	40
204030016	6W/M	600Lm/M	6000-6500K	2835	40

* Consulta el conexionado en el apartado info técnica.

IP44

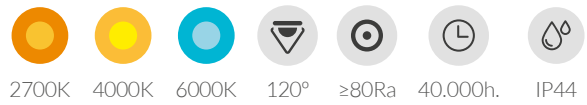

Rollo 5M tira LED SMD2835

Flexible, autoadhesiva y fija. 8mm anchura. Incluye adaptador **jack hembra** soldado en un extremo. Alimentación **DC 24V**. 120 LEDs por metro. **Cinta adhesiva 3M**. Es posible cortar por las zonas delimitadas cada 50mm.

Referencia	Potencia	Lúmenes	Luz	SMD	Embalaje
204030018	12W/M	1200Lm/M	● 2700-3000K	2835	40
204030019	12W/M	1200Lm/M	● 4000-4500K	2835	40
204030020	12W/M	1200Lm/M	● 6000-6500K	2835	40

IP44



Conector hembra

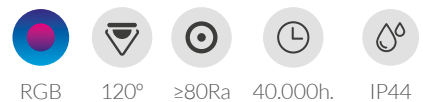

Rollo 5M tira LED SMD5050

Flexible, autoadhesiva. 10mm anchura. Incluye **conector con pines soldado** y **conector hembra**. Alimentación **DC 24V**. **Cinta adhesiva 3M**. Es posible cortar por las zonas delimitadas cada 165mm.

Referencia	Potencia	LED's/M	Corte cada	Luz	SMD	Embalaje
204030017	7.2W/M	30LED's/M	165mm	● RGB	5050	50
204030021	14.4W/M	60LED's/M	100mm	● RGB	5050	50

IP65

R

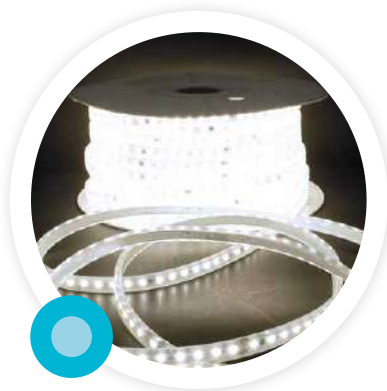
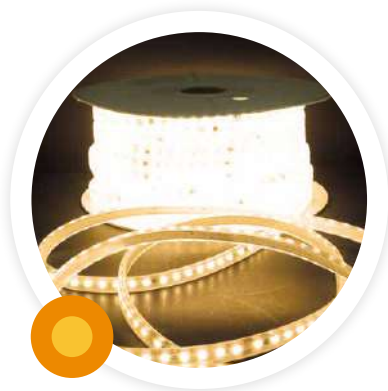

 Corte cada 100mm

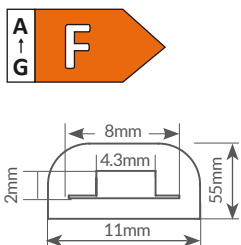

Ref. 204005006

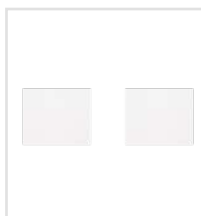

Ref. 204005007

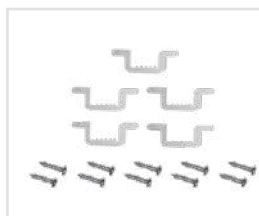







Ref. 204005008





Tiras de LED muy flexibles

Rollo 50M tira LED SMD2835

-  2700K
-  4000K
-  6000K
-  120°
-  ≥80Ra
-  40.000h.
-  IP65

Flexible, autoadhesiva, fija e impermeable. 10.8mm anchura. 5.5mm altura. **Regulables.**
Alimentación **AC 230V**. 120 LEDs por metro. **Cinta adhesiva 3M**. Es posible cortar por las zonas delimitadas cada 100mm.

Referencia	Potencia	Lúmenes	Luz	SMD	Embalaje
204030022	8W/M	800Lm/M	 2700-3000K	2835	1
204030023	8W/M	800Lm/M	 4000-4500K	2835	1
204030024	8W/M	800Lm/M	 6000-6500K	2835	1
204005006	Kit de corte para tira LED ref. 204030022 - 23 - 24				
204005007	Kit de tapas finales para tira LED ref. 204030022 - 23 - 24 - 31 - 32 - 33				
204005008	Kit 5u clips para tira LED ref. 204030022 - 23 - 24 - 31 - 32 - 33				

* Consulta el conexionado en el apartado info técnica.

IP65

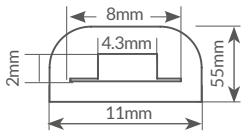

Ref. 204005012



Ref. 204005013

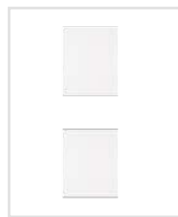

Ref. 204005007

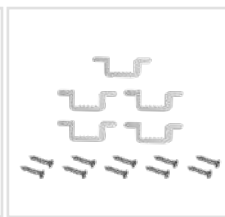

Ref. 204005008



Tiras de LED muy flexibles

Rollo 50M tira LED COB

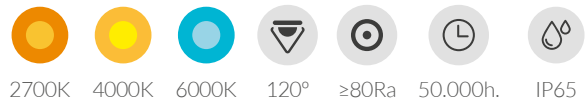

Flexible, autoadhesiva e impermeable. Regulables. Anchura: 10mm. Altura: 5mm. Recubrimiento para disipar los chips. Alimentación **DC 200V**. 360 LEDs por metro. Posibilidad de instalación con **clips** o **adhesivo**. **Cinta adhesiva 3M**. Es posible cortar por las zonas delimitadas cada 100mm. **Conexión máxima 50M**. Incluye 470mm de cable de alimentación y clavija.

Referencia	Potencia	Lúmenes	Luz	Embalaje
204030031	12W/M	700Lm/M	● 2700-3000K	1
204030032	12W/M	700Lm/M	● 4000-4500K	1
204030033	12W/M	700Lm/M	● 6000-6500K	1
204005012	Kit de corte para tira LED ref. 204030031 - 32 - 33			
204005013	Transformador 8A para tira LED ref. 204030031 - 32 - 33			
204005007	Kit de tapas finales para tira LED ref. 204030022 - 23 - 24 - 31 - 32 - 33			
204005008	Kit 5u clips para tira LED ref. 204030022 - 23 - 24 - 31 - 32 - 33			

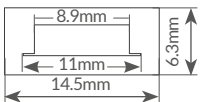

Ref. 204015001

Ref. 204005009

Ref. 204005010

Ref. 204005011

Rollo 50M tira LED SMD2835

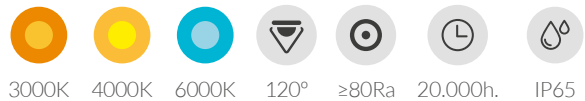

Flexible, autoadhesiva, fija e impermeable. 14mm anchura. 6mm altura. **Regulables.**

Alimentación **AC 230V**. 120 LEDs por metro. **Cinta adhesiva 3M.** Es posible cortar por las zonas delimitadas cada 100mm.

Referencia	Potencia	Lúmenes	Luz	SMD	Embalaje
204030025	17W/M	1700Lm/M	3000K	2835	1
204030027	17W/M	1700Lm/M	4000K	2835	1
204030028	17W/M	1700Lm/M	6000K	2835	1
204015001	Regulador de intensidad 1000W para tira LED ref. 204030025 - 27 - 28				
204005009	Kit cable alimentación 1M + tapa final para tira LED ref. 204030025 - 27 - 28				
204005010	Interconector 180mm para tira LED ref. 204030025 - 27 - 28				
204005011	Kit 5u clips 14mm para tira LED				

* Consulta el conexionado en el apartado info técnica.



- Rojo
- Verde
- Azul
- ≥80Ra
- 50.000h.
- IP20

Rollo 5M tira LED SMD2835

Flexible, fija y autoadhesiva. 8mm anchura. Uso interior. Blíster.
Alimentación **DC 24V**. 30 LEDs por metro. **Cinta adhesiva 3M**.
Es posible cortar por las zonas delimitadas cada 100mm (cada 6 LEDs).

Referencia	Potencia	Lúmenes	Luz	SMD	Embalaje
204030003	6W/M	200-400Lm	Rojo	2835	40
204030004	6W/M	200-400Lm	Verde	2835	40
204030005	6W/M	200-400Lm	Azul	2835	40



- 2800K
- 6000K
- ≥80Ra
- 50.000h.
- IP20

Kit 5M tira LED SMD2835

Flexible, autoadhesiva y fija. 8mm anchura. Uso interior. Blíster.
Kit preparado para conectar. Alimentación **DC 24V**. Incluye fuente de alimentación.
Cinta adhesiva 3M. Es posible cortar por las zonas delimitadas cada 100mm (cada 6 LEDs).

Referencia	Potencia	Lúmenes	Luz	SMD	Embalaje
204020000	6W/M	540Lm/M	2800-3200K	2835	40
204020001	6W/M	540Lm/M	6000-6500K	2835	40



Kit 5M tira LED SMD5050

Flexible, fija y autoadhesiva. Uso interior. Blíster. **Kit preparado para conectar.**

Alimentación **DC 24V**. Incluye fuente de alimentación. **Cinta adhesiva 3M**. Es posible cortar por las zonas delimitadas cada 100mm (cada 6 LEDs) en las tiras de 6W/M y cada 167mm en las tiras de 7.2W/M.

Referencia	Potencia	Anchura	Luz	SMD	Embalaje
204020003	6W/M	8mm	● Rojo	5050	40
204020004	6W/M	8mm	● Verde	5050	40
204020005	6W/M	8mm	● Azul	5050	40
204020002 ★	7.2W/M	10mm	● RGB	5050	40

* Consulta el conexionado en el apartado info técnica.

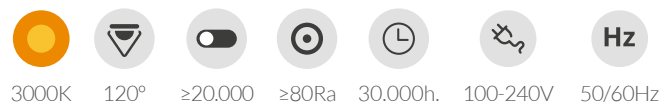
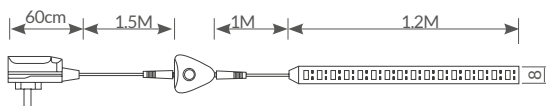
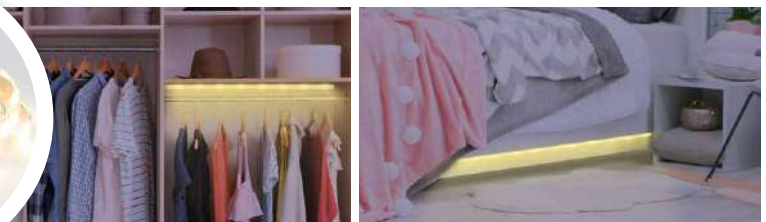

Kit tira LED con sensor de movimiento

Flexible, fija y autoadhesiva. 8mm anchura. **Intensidad regulable.** Tiempo regulable: 30", 130", 380".

Distancia de detección: 3.5M. Alimentación salida **DC 12V**. Alimentación entrada **100-240V**.

Cinta adhesiva 3M. Con **sensor crepuscular** (funciona cuando es de noche o en la oscuridad). IP accesorios: IP20. IP tira: **IP44**.

Referencia	Potencia	Lúmenes	Luz	Longitud	Embalaje
204020006	3W	200Lm	● 3000K	1.2M	25

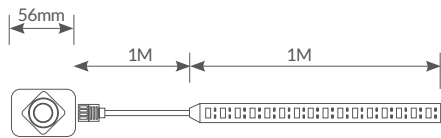

- 3000K
- 4200K
- 120°
- ≥20.000
- ≥80Ra
- 30.000h.

Kit tira LED con sensor de movimiento

Flexible, fija y autoadhesiva. 8mm anchura. **Intensidad regulable.** Tiempo regulable: 15", 130", 380".

Es posible cortar por las zonas delimitadas cada 100mm. **Distancia de detección:** 3.5M.

Cable USB de 25cm. Alimentación **DC 5V**. **Cinta adhesiva 3M**. **Sensor crepuscular** ajustable (modo día, noche y OFF).

Batería de 1000mAh (**recargable**). IP accesorios: IP20. IP tira: **IP44**.

Referencia	Potencia	Lúmenes	Luz	Longitud	Embalaje
204020008	2.4W	180Lm	3000K	1M	45
204020009	2.4W	180Lm	4200K	1M	45



- RGB
- ≥80Ra
- 20.000h.
- IP44

Tira LED USB 2x0.5M para TV

Flexible, impermeable y autoadhesiva. 10mm anchura. Uso exterior.

Alimentación **DC 5V**. 30 LEDs por metro. **Cinta adhesiva 3M**. Con mando.

Es posible cortar por las zonas delimitadas cada 35mm (cada LED).

Referencia	Potencia	Longitud	Luz	SMD	Embalaje
001504516	7.2W/M	2x0.5M	RGB	5050	10

Sonido

RÍTMICO



Cambia de color al ritmo de la música

- Mando con más de 25 efectos
- Intensidad regulable
- Sensor de sonido rítmico
- Función memoria

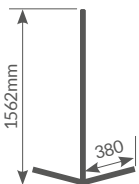

- 6500K
- RGB
- 120°
- ≥25.000
- ≥80Ra
- 30.000h.
- IP44
- 100-250V
- 50/60Hz

Lámpara de pie LED con sensor de sonido rítmico RGB + 6500K

Intensidad regulable. Temperatura regulable: RGB + 6500K. Función memoria del último estado de color. Con **sensor rítmico**: cambia al ritmo de la música. Incluye **mando con más de 25 efectos**. Ángulo de la base. 90°. Alimentación **DC 12V**. Material: **aluminio**, ABS y silicona. Fácil instalación, sin herramientas.

Referencia	Con difusor / Luminaria (360°)	Sin difusor / Fuente de luz (360°)	Luz	Embalaje
204405001	12W / 500Lm	12W / 1260Lm	6500K + RGB	5



A



B



C

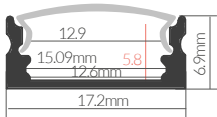

Kits perfiles de aluminio superficie

El kit incluye: perfil, difusor translúcido, tapas y clips. Material: aluminio.

Referencia	Artículo	Tipo	Color perfil	Para tira LED	Longitud	Instalación	Embalaje
204025036	A	Recto	Gris	Hasta 12mm	2M	Superficie	100
204095037	Accesorios tapas y clips para perfil tira LED ref. 204025036						
204095040	Recambio difusor negro para perfil tira LED ref. 204025036-37-38						
204025037	B	Recto	Blanco	Hasta 12mm	2M	Superficie	200
204095038	Accesorios tapas y clips para perfil tira LED ref. 204025037						
204095040	Recambio difusor negro para perfil tira LED ref. 204025036-37-38						
204025038	C	Recto	Negro	Hasta 12mm	2M	Superficie	200
204095039	Accesorios tapas y clips para perfil tira LED ref. 204025038						
204095040	Recambio difusor negro para perfil tira LED ref. 204025036-37-38						



D



E



F

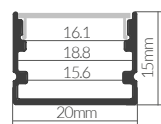
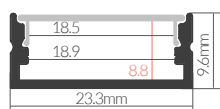
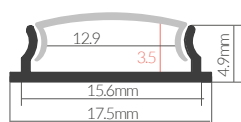

Kits perfiles de aluminio superficie

El kit incluye: perfil, difusor translúcido, tapas y clips. Material: aluminio.

Referencia	Artículo	Tipo	Para tira LED	Longitud	Instalación	Embalaje
204025035	D	Ovalado	Hasta 14mm	2M	Superficie	200
204095036	Accesorios tapas y clips para perfil tira LED ref. 204025035					
204025039	E	Recto	Hasta 21mm	2M	Superficie	100
204095041	Accesorios tapas y clips para perfil tira LED ref. 204025039					
204025046	F	Recto	De hasta 15mm	2M	Superficie	50
204095049	Recambio tapa con agujero para perfil tira LED ref. 204025046					



A

Ideal tira LED 230V



B



C



Se puede pisar

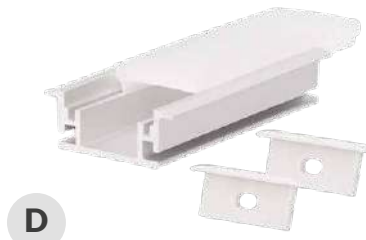

D



Se puede pisar

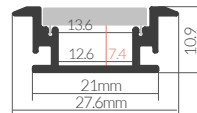
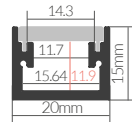
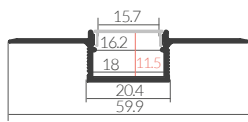
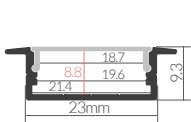

Kits perfiles de aluminio empotrables

El kit incluye: perfil, difusor translúcido y tapas. Material: aluminio.

Referencia	Artículo	Tipo	Para tira LED	Longitud	Instalación	Embalaje
204025047	A	Curvo	Hasta 19mm	2M	Empotrable	50
204095050	Accesorios tapas para perfil tira LED ref. 204025047					
204025048	B	Recto	Hasta 12.5mm	2M	Empotrable / Pladur	100
204095051	Accesorios tapas para perfil tira LED ref. 204025048					
204025049	C	Recto	Hasta 10mm	2M	Empotrable / Suelo	100
204095052	Accesorios tapas para perfil tira LED ref. 204025049					
204025050	D	Recto	Hasta 12mm	2M	Empotrable / Suelo exterior	100
204095054	Accesorios tapas para perfil tira LED ref. 204025050					

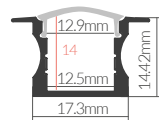
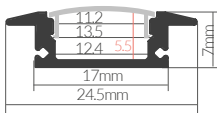

Kits perfiles de aluminio empotrables

El kit incluye: perfil, difusor translúcido y tapas. Material: aluminio.

Referencia	Artículo	Tipo	Para tira LED	Longitud	Instalación	Embalaje
204025040	E	Curvo	Hasta 12mm	2M	Empotrar	100
204095042	Accesorios tapas para perfil tira LED ref. 204025040					
204095045	Recambio difusor negro para perfil tira LED ref. 204025040-41-42					
204025041	F	Curvo	Hasta 12mm	2M	Empotrar	100
204095043	Accesorios tapas para perfil tira LED ref. 204025041					
204095045	Recambio difusor negro para perfil tira LED ref. 204025040-41-42					
204025042	G	Curvo	Hasta 12mm	2M	Empotrar	100
204095044	Accesorios tapas para perfil tira LED ref. 204025042					
204095045	Recambio difusor negro para perfil tira LED ref. 204025040-41-42					
204025051	H	Curvo	Hasta 12mm	2M	Empotrar	100
204095056	Accesorios tapas para perfil tira LED ref. 204025051					



A



B



C

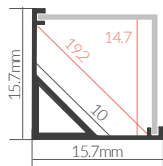
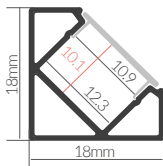
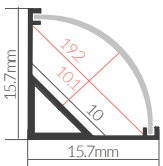

Kits perfiles de aluminio esquineros

El kit incluye: perfil, difusor translúcido, tapas y clips. Material: aluminio.

Referencia	Artículo	Tipo	Para tira LED	Longitud	Instalación	Embalaje
204025043	A	Esquinero ovalado	De hasta 10mm	2M	Superficie	100
204095046	Accesorios tapas y clips para perfil tira LED ref. 204025043					
204025044	B	Esquinero curvo	De hasta 12mm	2M	Superficie	50
204095047	Accesorios tapas y clips para perfil tira LED ref. 204025044					
204025045	C	Esquinero recto	De hasta 10mm	2M	Superficie	100
204095048	Accesorios tapas y clips para perfil tira LED ref. 204025045					

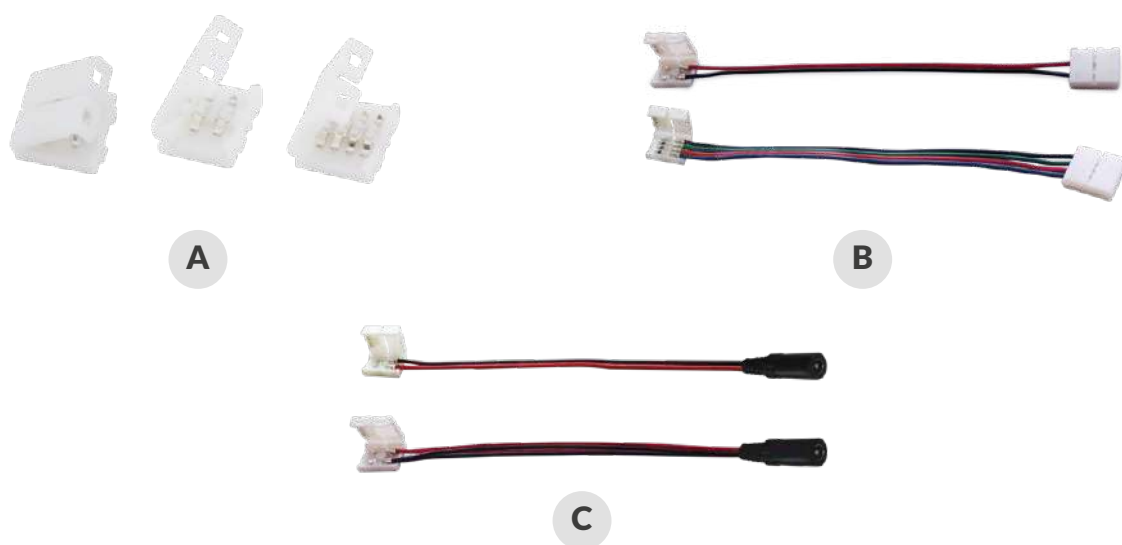

Unión para tiras LED

Tipo: unión. Fácil conexión.

Referencia	Artículo	Ancho	Longitud	Para tira LED	Embalaje
001501519	A	8mm	-	SMD 3528/2835	400
001501520	A	10mm	-	SMD 5050/Fija	400
001501521	A	10mm	-	SMD 5050/RGB	400
001501594	B	8mm	170mm	SMD 3528/2835	100
001501595	B	10mm	170mm	SMD 5050/Fija	100
001501596	B	10mm	170mm	SMD 5050/RGB	100
001502693	C	8mm	170mm	SMD 3528/2835	100
001502694	C	10mm	170mm	SMD 5050/RGB	100



Unión para tiras LED y fuentes de alimentación

Tipo: unión. Fácil conexión.

Referencia	Tipo	Longitud	Embalaje
001501522	Hembra	50cm	500
001504520	Macho	50cm	100



A Forma "L" / 8mm



B Forma "L" / 10mm



C Forma "T" / 8mm



D Forma "T" / 10mm



E Forma "X" / 8mm



F Forma "X" / 10mm

Conectores para tiras LED

Tipo: unión. Fácil conexión.

Referencia	Artículo	Tipo	Ancho	Para tira LED	Embalaje
001502696	A	Forma "L"	8mm	SMD 3528 / 2835	100
001502697	B	Forma "L"	10mm	SMD 5050 / Fija	100
001502698	B	Forma "L"	10mm	SMD 5050 / RGB	100
204005002	C	Forma "T"	8mm	SMD 5050	400
204005003	D	Forma "T"	10mm	SMD 5050 / RGB	400
204005004	E	Forma "X"	8mm	SMD 2835	400
204005005	F	Forma "X"	10mm	SMD 5050 / RGB	400





Conector macho/hembra a conector rápido

Para tiras de LED RGB.

Referencia	Ancho	Para tira LED	Embalaje
001504522	10mm	De 24V a RGB	100

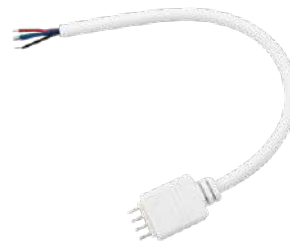

Conector hembra/macho a controlador

Para tiras de LED RGB.

Referencia	Ancho	Para tira LED	Embalaje
001504523	10mm	De 24V a RGB	100



Conector macho a hembra DC + interruptor

Para tiras de LED de 24V.

Referencia	Longitud	Para tira LED	Embalaje
001504524	360mm	De 24V	100



Alargador macho a hembra DC

Para tiras de LED de 24V.

Referencia	Longitud	Para tira LED	Embalaje
001504525	2M	De 24V	100





Alargador macho a hembra DC

Para tiras de LED RGB de 24V.

Referencia	Longitud	Para tira LED	Embalaje
204005001	1M	RGB de 24V	200



Mini regulador intensidad para tiras LED

Para tiras de LED monocolor. De macho a hembra DC.

Referencia	Salida	Para tira LED	Embalaje
001504526	12-24V	Monocolor	100



Regulador intensidad tiras LED



61x33x32mm

Corriente: 2A. Iluminación de 0% a 100%.

Referencia	Potencia.	Salida	Embalaje
001504507	Máx. 24W	12-24V	100



Regulador intensidad tiras LED



60x35x89mm

Corriente: <8A. Un canal de salida.

Referencia	Potencia.	Salida	Embalaje
001501517	Máx. 96W	12-24V	100



Controlador + Clip 4 pins

Para tiras de LED RGB de 24V.

Incluye: **controlador LED RGB** con conector jack, **conector de tira RGB** 10mm a controlador, pin **4 puntas RGB** y **mando controlador RGB**.

Referencia	Para tira LED	Embalaje
204005000	RGB de 24V	200

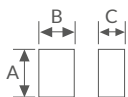

Controlador para tiras LED RGB

Con mando de 24 botones. 16 cambios luminosos. Ajuste de velocidad de parpadeo.

Referencia	Potencia	Salida	Dimensión(AxBxC)	Dimensión mando	Embalaje
001500301	Máx. 144W	12-24V	130x65x23mm	52x7x84mm	40



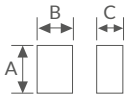

Controlador para tiras LED RGB

Con mando táctil. 16 cambios luminosos. Ajuste de velocidad de parpadeo. El mando utiliza 3 pilas LR03 / AAA (incluidas).

Referencia	Potencia	Salida	Dimensión (AxBxC)	Dimensión mando	Embalaje
001501518	Máx. 216W	12-24V	127x40x32mm	55x23x113mm	50

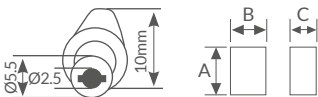

Fuente alimentación para tiras LED

Longitud cable: 1.5M. IP20.

Referencia	Potencia	Voltaje	Dimensión (AxBxC)	Embalaje
204000001	Máx. 36W	De 220-240V a 24V	50x30x100mm	50



A



B



C



D

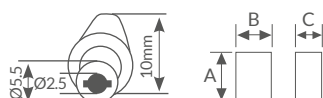

Fuente alimentación para tiras LED

IP20.

Referencia	Artículo	Potencia	Intensidad	Voltaje	Dimensión (AxBxC)	Embalaje
001504527	A	Máx. 24W	1A	230 a 24V	83x43x31mm	60
001504528	B	Máx. 48W	2A	230 a 24V	120x60x37mm	36
001504529	B	Máx. 60W	2.5A	230 a 24V	120x60x38mm	100
001501523	C	Máx. 12W	1A	230 a 12V	75x42x28mm	88
001501524	C	Máx. 24W	2A	230 a 12V	83x43x31mm	60
001504521	C	Máx. 36W	3A	230 a 12V	94x47x33mm	50
001500300	D	Máx. 48W	4A	230 a 12V	120x60x37mm	50
001501513	D	Máx. 60W	5A	230 a 12V	120x60x38mm	36



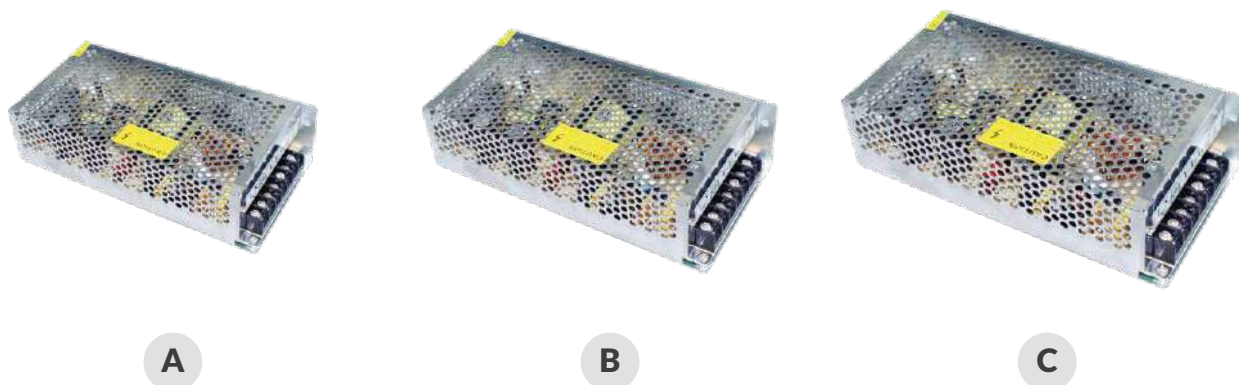

A

B

C

Fuente alimentación para tiras LED

De 230V a 24V. IP20.

Referencia	Artículo	Canal salida	Potencia	Intensidad	Dimensión	Embalaje
001504573	A	1	15W	0.6A	49x77x20mm	75
204000002	A	1	25W	1A	58x85x38mm	100
001504574	A	1	36W	1.5A	58x85x38mm	75
001504575	A	1	60W	2.5A	97x165x37mm	30
001504576	B	2	100W	4.1A	98x230x42mm	28
001504577	B	2	150W	6.2A	98x230x42mm	25
001504578	B	2	200W	8.3A	110x203x50mm	24
001504579	B	2	250W	10.4A	110x205x50mm	24
001504580	C	3	350W	14.5A	113x214x49mm	20



Fuente alimentación estanca para tiras LED

De 230V a 24V. IP67.

Referencia	Potencia	Intensidad	Dimensión	Embalaje
001504581	60W	2.5A	180x71x43mm	10
001504582	100W	4.1A	251x71x43mm	10
001504583	150W	6.2A	251x71x43mm	10
001504584	200W	8.3A	232x120x55mm	10



Soportes y accesorios TV

Soportes

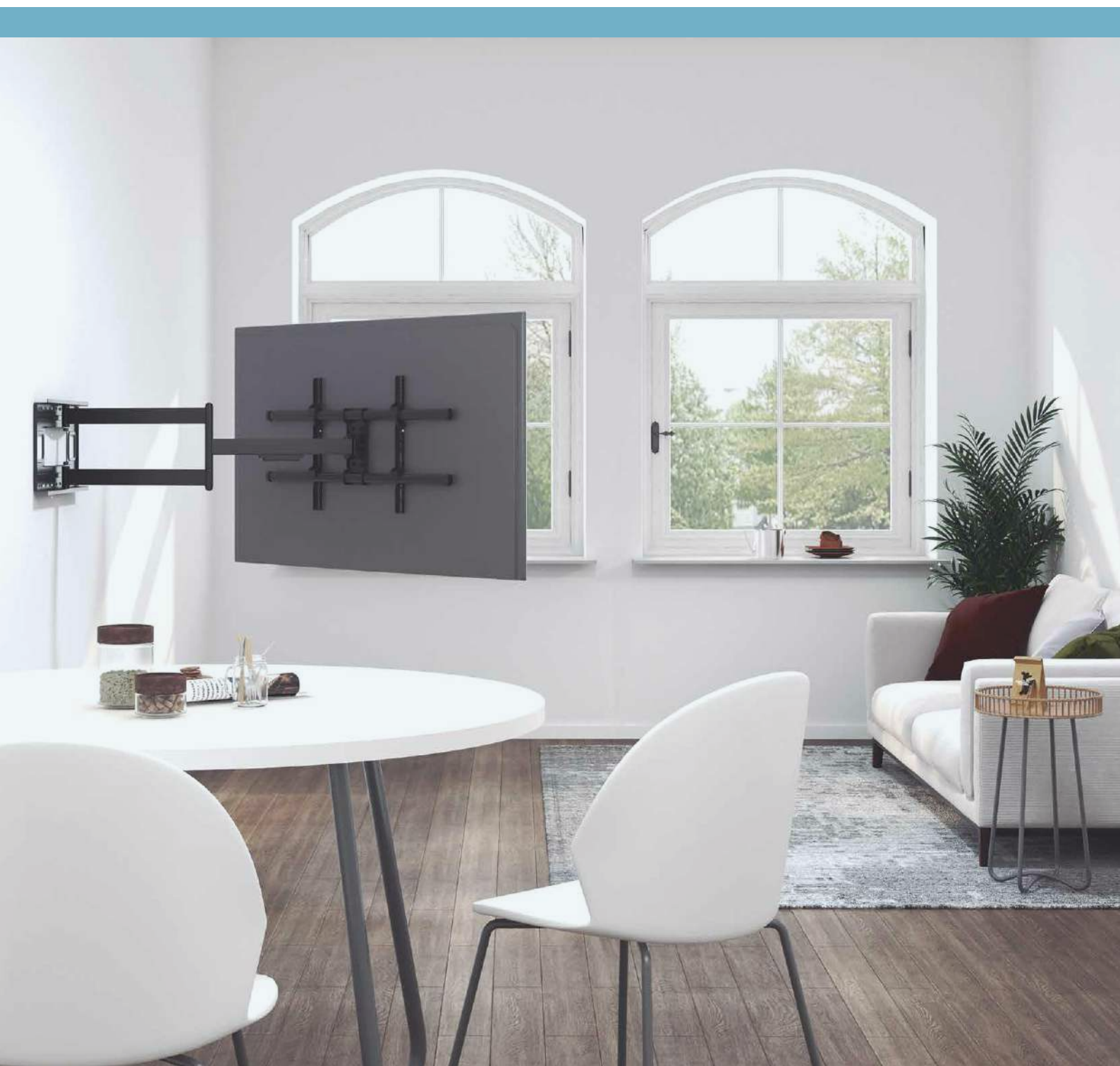

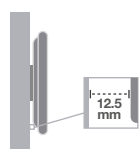

A Material acero

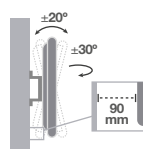

B Material acero

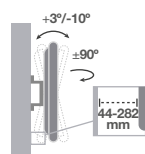

C Material acero + plástico

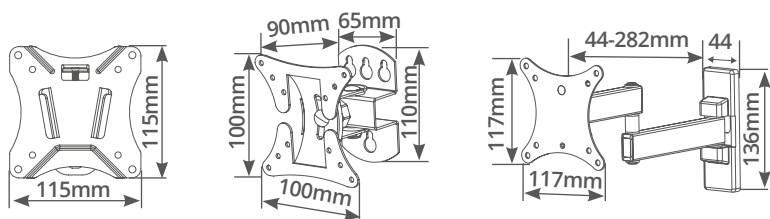

Soporte TV 13" - 27"



Sistema de anclaje universal VESA 75x75 / 100x100. Color: negro.
Accesorios incluidos. Compatible con todas las marcas. Fácil instalación.

Referencia	Artículo	Tipo	Peso máximo	Inclinación	Oscilación	Embalaje
500055000	A	Fijo	25Kg. / 55lbs	-	-	40
500055001	B	Inclinable	30Kg. / 66lbs	Arriba / Abajo ±20°	Lateral ±30°	20
500055002	C	Brazo inclinable	15Kg. / 33lbs	Arriba / Abajo +3° - 10°	Lateral ±90°	20

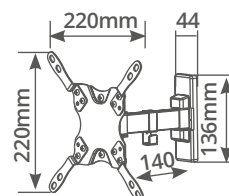
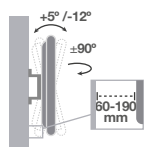

Soporte TV 13" - 42"



Sistema de anclaje universal **VESA 75x75 / 100x100 / 200x100 / 200x200**.
 Color: negro. **Rotación ±3**. Accesorios incluidos. Compatible con todas las marcas.
 Apto para **pantallas planas y curvas**. Material: **acero y plástico**. Fácil instalación.

Referencia	Tipo	Peso máximo	Inclinación	Oscilación	Embalaje
500055016	Brazo inclinable	20Kg. / 44lbs	Arriba / Abajo +5° - 12°	Lateral ±90°	10

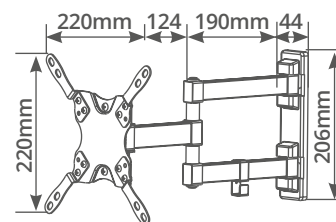
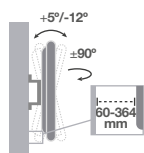

Soporte TV 13" - 42"



Sistema de anclaje universal **VESA 75x75 / 100x100 / 200x100 / 200x200**.
 Color: negro. **Rotación ±3**. Accesorios incluidos. Compatible con todas las marcas.
 Apto para **pantallas planas y curvas**. Material: **acero**. Fácil instalación.

Referencia	Tipo	Peso máximo	Inclinación	Oscilación	Embalaje
500055017	Brazo doble inclinable	20Kg. / 44lbs	Arriba / Abajo +5° - 12°	Lateral ±90°	8

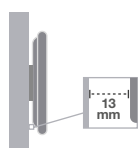

A Material aluminio

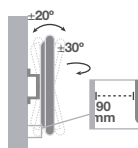

B Material acero

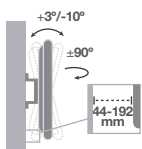

C Material acero + plástico

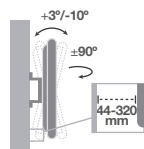
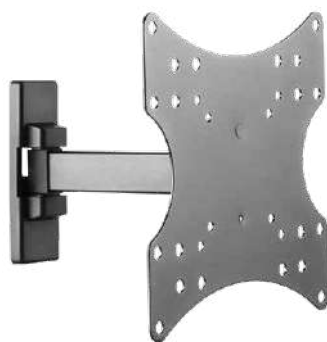

D Material acero + plástico

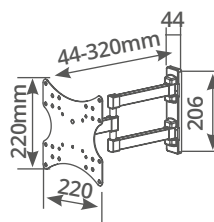
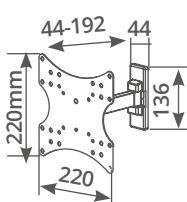
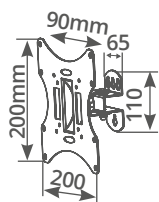
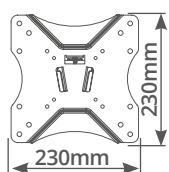
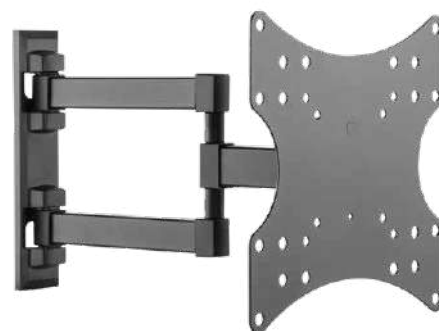

Soporte TV 23" - 42"



Sistema de anclaje universal VESA. Color: negro.

VESA 75x75 / 100x100 / 200x100 / 200x200 (500055003-04).

VESA 75x75 / 100x100 / 100x150 / 150x100 / 150x150 / 200x100 / 200x200 (500055005-06).

Compatible con todas las marcas. Accesorios incluidos. Fácil instalación.

Referencia	Artículo	Tipo	Peso máximo	Inclinación	Oscilación	Rotación	Emb.
500055003	A	Fijo	25Kg. / 55lbs	-	-	-	12
500055004	B	Inclinable	30Kg. / 66lbs	Arriba / Abajo ±20°	Lateral ±30°	±3°	10
500055005	C	Brazo inclinable	20Kg. / 44lbs	Arriba / Abajo +3° - 10°	Lateral ±90°	±3°	14
500055006	D	Brazo doble inclinable	20Kg. / 44lbs	Arriba / Abajo +3° - 10°	Lateral ±90°	±3°	10

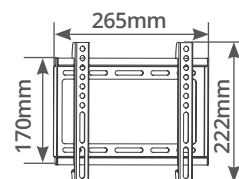
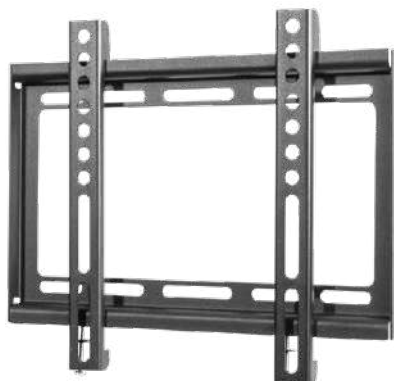
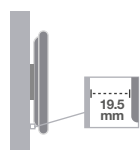

HOLMIOS®

Soporte fijo TV 23" - 42"

Sistema de anclaje universal **VESA 50x50 / 75x75 / 100x100 / 200x100 / 200x200**. Color: negro.
Material: **acero**. Accesorios incluidos. Compatible con todas las marcas. Material: **acero**. Fácil instalación.

Referencia	Tipo	Peso máximo	Embalaje
500055007	Fijo	35Kg. / 77lbs	20

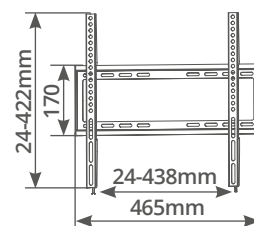
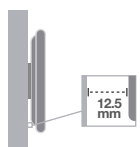

HOLMIOS®

Soporte fijo TV 32" - 55"

Sistema de anclaje universal **VESA 200x200 / 300x300 / 400x200 / 400x400**. Color: negro.
Material: **acero**. Accesorios incluidos. Compatible con todas las marcas. Material: **acero**. Fácil instalación.

Referencia	Tipo	Peso máximo	Embalaje
500055008	Fijo	35Kg. / 77lbs	12

SOPORTES

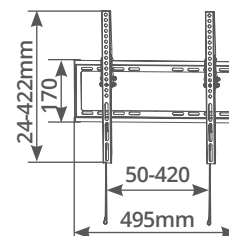
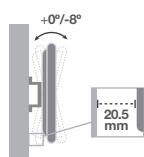

HOLMIOS®

Soporte TV 32" - 55"

Sistema de anclaje universal **VESA 200x200 / 300x300 / 400x200 / 400x400**. Color: negro. Accesorios incluidos. Compatible con todas las marcas. Material: **acero y plástico**. Fácil instalación.

Referencia	Tipo	Peso máximo	Inclinación	Embalaje
500055010	Fijo inclinable	35Kg. / 77lbs	Arriba / Abajo +0° - 8°	12

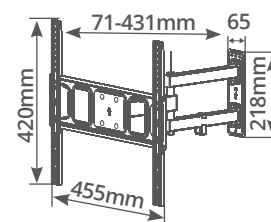
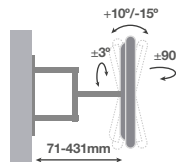

HOLMIOS®

Soporte TV 32" - 55"

Sistema de anclaje universal **VESA 75x75 / 100x100 / 100x150 / 100x200 / 150x100 / 150x150 / 200x100 / 200x200 / 300x200 / 300x300 / 400x200 / 400x300 / 400x400**. Color: negro. Rotación: ±3°. Organizador de cables. Accesorios incluidos. Compatible con todas las marcas. Material: **acero y plástico**. Fácil instalación.

Referencia	Tipo	Peso máximo	Inclinación	Oscilación	Embalaje
500055012	Brazo inclinable	35Kg. / 77lbs	Arriba / Abajo +10° - 15°	Lateral ±90°	6

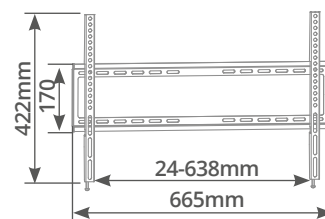

HOLMIOS®

Soporte TV 37" - 70"

Sistema de anclaje universal **VESA 200x200 / 300x300 / 400x200 / 400x400 / 600x400**. Color: negro. Accesorios incluidos. Compatible con todas las marcas. Material: **acero**. Fácil instalación.

Referencia	Tipo	Peso máximo	Embalaje
500055009	Fijo	35Kg. / 77lbs	10

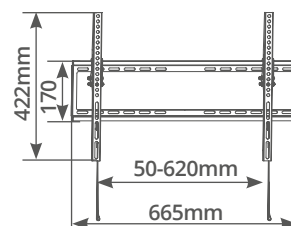

HOLMIOS®

Soporte TV 37" - 70"

Sistema de anclaje universal **VESA 200x200 / 300x300 / 400x200 / 400x400 / 600x400**. Color: negro. Accesorios incluidos. Compatible con todas las marcas. Material: **acero y plástico**. Fácil instalación.

Referencia	Tipo	Peso máximo	Inclinación	Embalaje
500055011	Fijo inclinable	35Kg. / 77lbs	Arriba / Abajo +0° - 8°	10

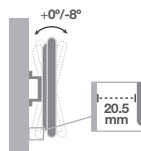

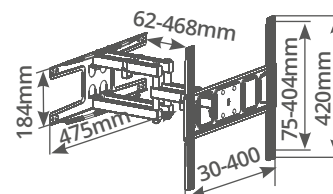
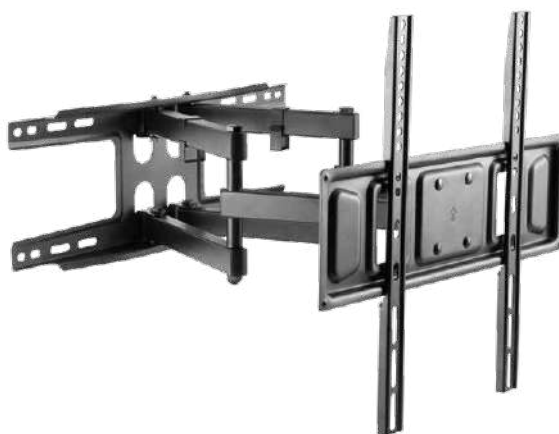
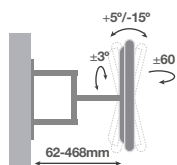

HOLMIOS®

Soporte TV 32" - 70"

Sistema de anclaje universal VESA 75x75 / 100x100 / 100x150 / 100x200 / 150x100 / 150x150 / 200x100 / 200x200 / 300x200 / 300x300 / 400x200 / 400x300 / 400x400. Color: negro.

Rotación ±3°. Brazo regulable. Organizador de cables. Accesorios incluidos. Compatible con todas las marcas. Apto para pantallas planas y curvas. Material: acero. Fácil instalación.

Referencia	Tipo	Peso máximo	Inclinación	Oscilación	Embalaje
500055018	Brazo inclinable	40Kg. / 88lbs	Arriba / Abajo +5° - 15°	Lateral ±60°	4

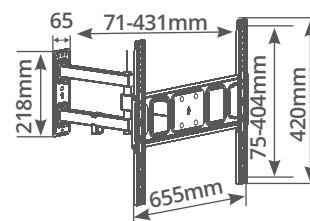
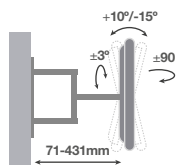

HOLMIOS®

Soporte TV 37" - 70"

Sistema de anclaje universal VESA 75x75 / 100x100 / 100x150 / 100x200 / 150x100 / 150x150 / 200x100 / 200x200 / 300x200 / 300x300 / 400x200 / 400x300 / 400x400 / 600x400.

Color: negro. Rotación: ±3°. Accesorios incluidos. Compatible con todas las marcas. Material: acero y plástico. Fácil instalación.

Referencia	Tipo	Peso máximo	Inclinación	Oscilación	Embalaje
500055013	Brazo inclinable	35Kg. / 77lbs	Arriba / Abajo +10° - 15°	Lateral ±90°	4

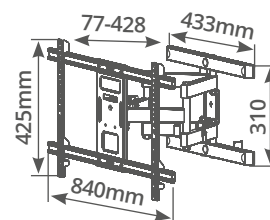
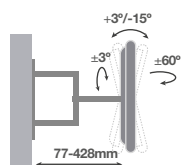

HOLMIOS®

Soporte con brazo TV 43" - 90"

Sistema de anclaje universal **VESA 300x200 / 300x300 / 400x200 / 400x300 / 400x400 / 600x400 / 800x400.**

Color: negro. **Rotación** ±3°. **Brazo regulable.** Organizador de cables. Accesorios incluidos.

Compatible con todas las marcas. Apto para **pantallas planas y curvas.**

Material: **acero y plástico.** Fácil instalación.

Referencia	Tipo	Peso máximo	Inclinación	Oscilación	Embalaje
500055023	Brazo doble inclinable	60Kg./ 132lbs	Arriba / Abajo +3° - 15°	Lateral ±60°	4

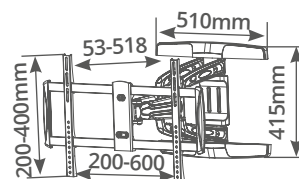
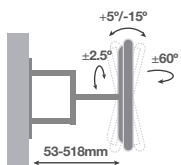

HOLMIOS®

Soporte Pro TV con brazo 37" - 80"

Sistema de anclaje universal **VESA 200x200 / 300x300 / 400x200 / 400x400 / 600x400.**

Color: negro. **Rotación:** ±2.5°. Accesorios incluidos. Compatible con todas las marcas. Apto para **pantallas planas y curvas.** Material: **hierro, aluminio y plástico.** Fácil instalación.

Referencia	Tipo	Peso máximo	Inclinación	Oscilación	Embalaje
500055020	Brazo doble inclinable	50Kg./ 110lbs	Arriba / Abajo +5° - 15°	Lateral ±60°	2





Potente imán
para un plegado
perfecto

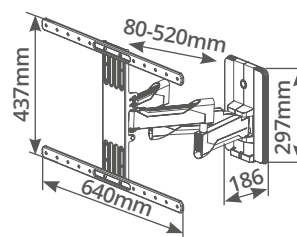
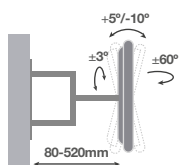

Soporte PRO TV 37" - 80"



Sistema de anclaje universal **VESA 200x200 / 300x200 / 300x300 / 400x200 / 400x300 / 400x400 / 600x400**.

Color: negro. **Rotación** ±3°. Incluye organizador de cable. Accesorios incluidos. Compatible con todas las marcas.

Apto para **pantallas planas y curvas**. Material: **acero**. Fácil instalación.

Referencia	Tipo	Peso máximo	Inclinación	Oscilación	Embalaje
500055019	Brazo doble inclinable	45Kg. / 99lbs	Arriba / Abajo +5° - 10°	Lateral ±60°	3



Ultrafino sólo le separan 23mm de la pared

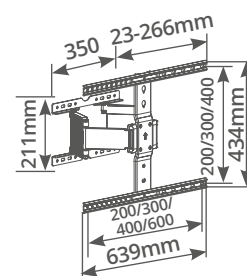
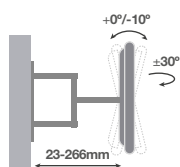
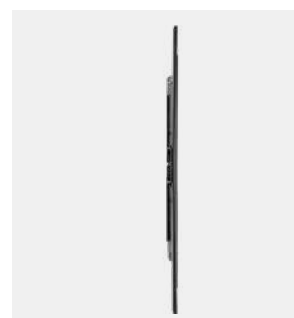
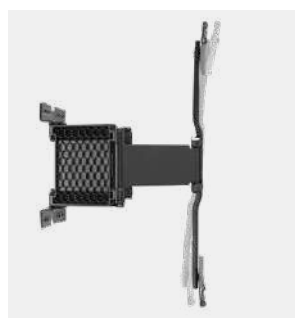
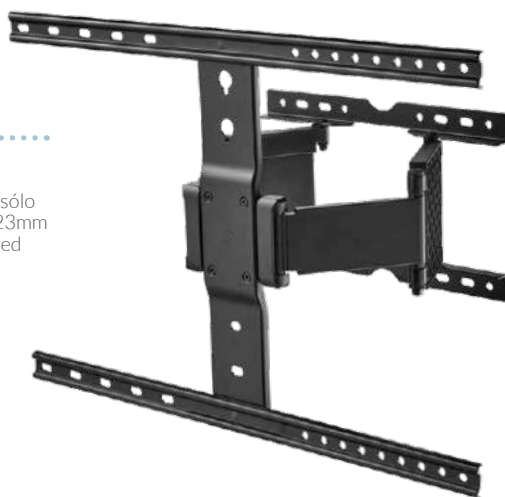

Soporte TV con brazo 37" - 80"



Sistema de anclaje universal VESA 200x200 / 400x200 / 300x300 / 400x400 / 600x400 / 800x400 / 600x600 / 1000x400 / 800x600 / 1000x600 / 800x800 / 1000x800. Color: negro. Rotación $\pm 1^\circ$. Material: **acero, aluminio y plástico**. Apto para pantallas **planas y curvas**. Organizador de cables. Accesorios incluidos. Compatible con todas las marcas. Fácil instalación.

Referencia	Tipo	Peso máximo	Inclinación	Oscilación	Distancia	Embalaje
500055027	Brazo doble	50Kg. / 110lbs	Arriba / Abajo $+0^\circ - 10^\circ$	Lateral $\pm 30^\circ$	23-266mm	3

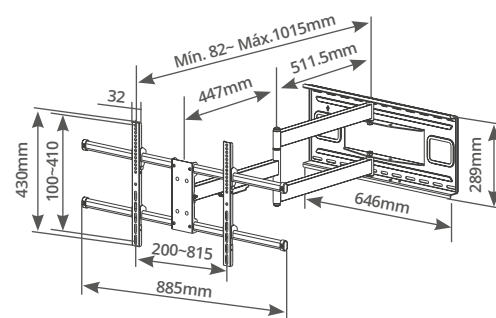
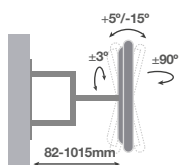
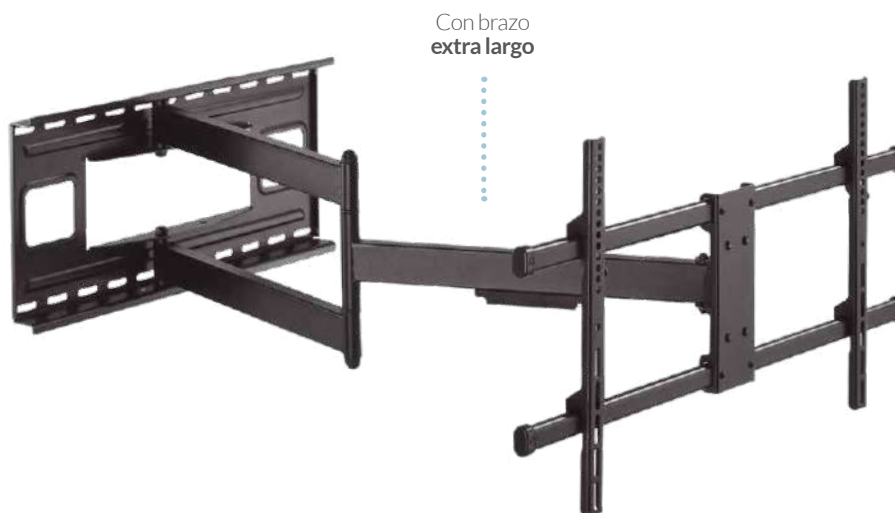

Soporte TV pared con brazo extralargo 43" - 80"



Sistema de anclaje universal **VESA 200x200 / 300x200 / 300x300 / 400x200 / 400x300 / 400x400 / 600x400 / 800x400**.
 Color: negro. **Rotación** ±3°. Incluye organizador de cable. Accesorios incluidos. Incluye nivel. Compatible con todas las marcas.
 Apto para **pantallas planas y curvas**. Material: **acero**. Fácil instalación.

Referencia	Tipo	Peso máximo	Inclinación	Oscilación	Embalaje
500055028	Extra largo	50Kg. / 110lbs	Arriba / Abajo +5° - 15°	Lateral ±90°	2

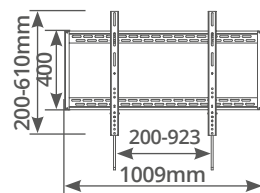
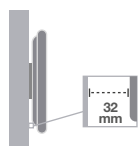

Soporte TV fijo 60" - 100" Heavy Duty

HOLMIOS®

Sistema de anclaje universal **VESA 200x200 / 400x200 / 300x300 / 400x400 / 600x400 / 800x400 / 800x600 / 900x600**.
 Color: negro. Material: **acero**. Apto para pantallas **planas y curvas**.
 Accesorios incluidos. Compatible con todas las marcas. Fácil instalación.

Referencia	Tipo	Peso máximo	Embalaje
500055025	Fijo	100Kg. / 220lbs	3

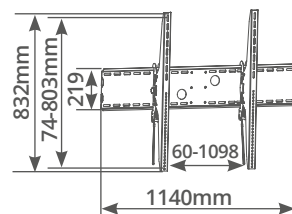
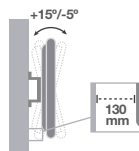

Soporte TV 60" - 100" Heavy Duty

HOLMIOS®

Sistema de anclaje universal **VESA 200x200 / 400x200 / 300x300 / 400x400 / 600x400 / 800x400 / 600x600 / 1000x400 / 800x600 / 1000x600 / 800x800 / 1000x800**. Color: negro. Material: **acero**. Accesorios incluidos. Compatible con todas las marcas. Fácil instalación.

Referencia	Tipo	Peso máximo	Inclinación	Embalaje
500055026	Inclinable	100Kg. / 220lbs	Arriba / Abajo +15° - 5°	2



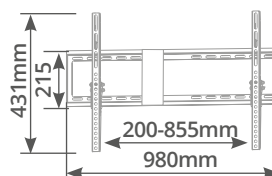
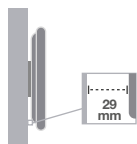
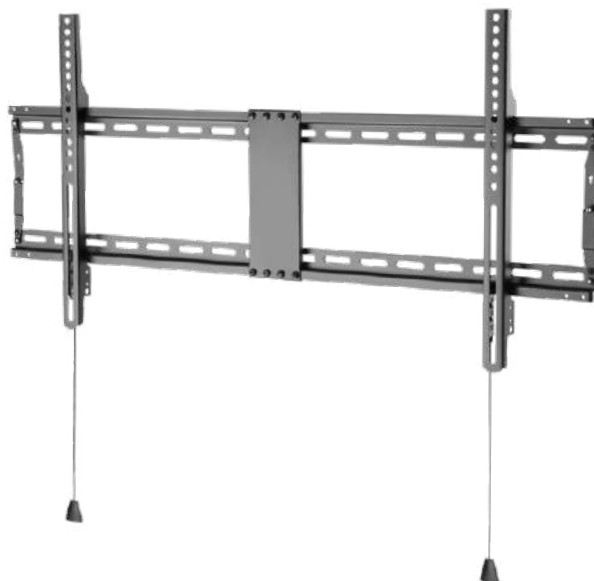

HOLMIOS®

Soporte antirrobo TV 43" - 90"

Sistema de anclaje universal **VESA 200x200 / 300x200 / 300x300 / 400x200 / 400x300 / 400x400 / 600x400 / 800x400**.
Sistema antirrobo. Incluye nivel. Color: negro. Accesorios incluidos. Compatible con todas las marcas.
 Apto para **pantallas planas y curvas**. Material: **acero**. Fácil instalación.

Referencia	Tipo	Peso máximo	Embalaje
500055021	Fijo	70Kg. / 154lbs	6

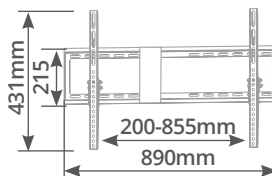
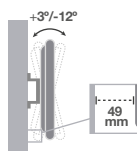

HOLMIOS®

Soporte antirrobo TV 43" - 90"

Sistema de anclaje universal **VESA 200x200 / 300x200 / 300x300 / 400x200 / 400x300 / 400x400 / 600x400 / 800x400**.
Sistema antirrobo. Incluye nivel. Color: negro. Accesorios incluidos. Compatible con todas las marcas.
 Apto para **pantallas planas y curvas**. Material: **acero**. Fácil instalación.

Referencia	Tipo	Peso máximo	Inclinación	Embalaje
500055022	Inclinable	70Kg. / 154lbs	Arriba / Abajo +3° - 12°	6

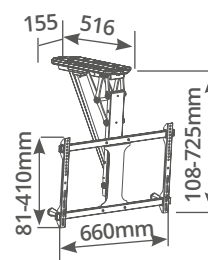
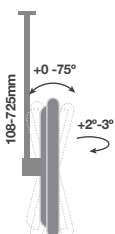

Soporte techo motorizado TV 32" - 70"



Sistema de anclaje universal **VESA 200x100 / 200x200 / 200x400 / 300x200 / 300x300 / 400x200 / 400x300 / 400x400 / 600x400**.
 Montaje en techo plano e inclinado. Color: negro. Accesorios incluidos. Compatible con todas las marcas.
 Apto para **pantallas planas y curvas**. Material: **acero y plástico**. Fácil instalación.

Referencia	Tipo	Peso máximo	Inclinación	Embalaje
500057001	Motorizado	35Kg. / 77lbs	Arriba / Abajo +0° - 75°	2

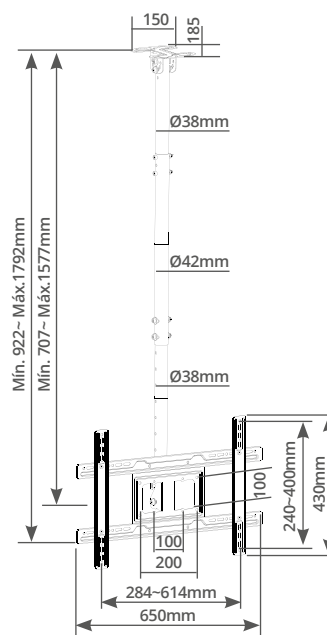
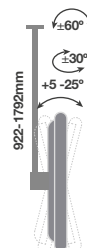
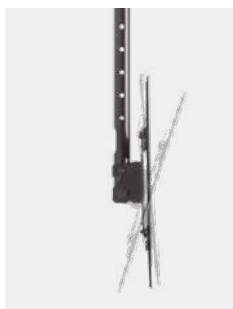

Soporte TV techo giratorio 37" - 80"



Sistema de anclaje universal VESA 200x200 / 300x200 / 400x200 / 300x300 / 400x300 / 400x400 / 600x400.
 Color: negro. Rotación $\pm 3^\circ$. Incluye organizador de cable. Accesorios incluidos. Compatible con todas las marcas.
 Apto para pantallas planas. Material: acero y plástico. Fácil instalación.

Referencia	Tipo	Peso máximo	Inclinación	Oscilación	Embalaje
500055029	Techo	50Kg./ 110lbs	Arriba/ Abajo +5° - 25°	Lateral $\pm 90^\circ$	2

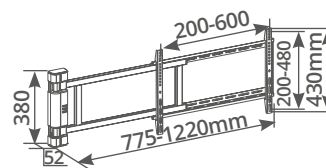
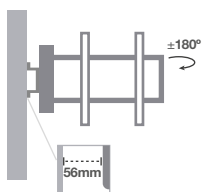
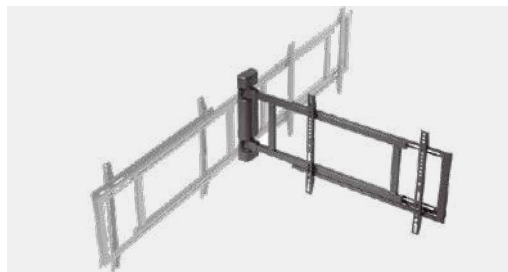

Soporte TV 32" - 75"

HOLMIOS®

Sistema de anclaje universal VESA 200x200 / 200x300 / 300x200 / 200x400 / 400x200 / 300x300 / 300x400 / 400x300 / 600x200 / 400x400 / 600x300 / 600x400. Color: negro.

Organizador de cables. Accesorios incluidos. Compatible con todas las marcas.

Apto para pantallas planas y curvas. Material: acero, aluminio y plástico. Fácil instalación.

Referencia	Tipo	Peso máximo	Oscilación	Embalaje
500055024	Abatible	50Kg. / 110lbs	Lateral +180° - 0°	3



Abatible a ambos lados
Producto mejorado
para TV más grandes

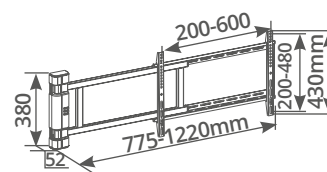
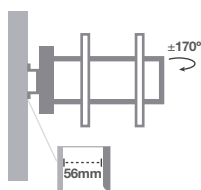
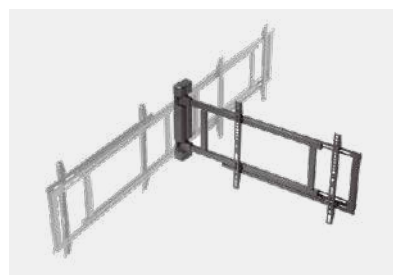
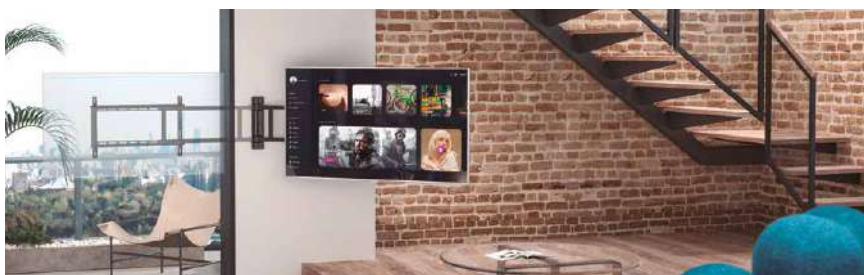

Soporte motorizado TV 32" - 75"



Sistema de anclaje universal VESA 200x200 / 200x300 / 300x200 / 200x400 / 400x200 / 300x300 / 300x400 / 400x300 / 600x200 / 400x400 / 600x300 / 600x400. Color: negro.

Con mando: 2xAAA (No incl.) Alimentación 100-240V ~50/60Hz. DC 12V 1A. Organizador de cables. Accesorios incluidos. Compatible con todas las marcas. Apto para pantallas planas y curvas. Material: acero, aluminio y plástico. Fácil instalación.

Referencia	Tipo	Peso máximo	Oscilación	Embalaje
500057003	Motorizado abatible	50Kg. / 110lbs	Lateral +170° -0°	3

SOPORTES



Función anti-colisión



Altura regulable 87~273mm

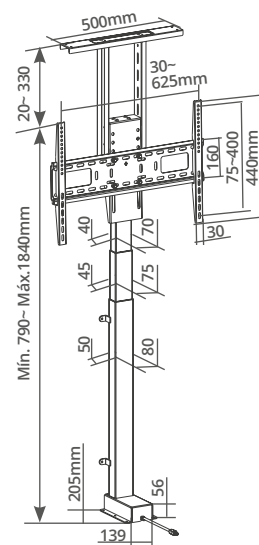

Soporte elevador motorizado inteligente 37" - 80"



Sistema de anclaje universal VESA 200x200 / 200x300 / 300x200 / 200x400 / 400x200 / 300x300 / 300x400 / 400x300 / 600x200 / 350x350 / 400x400 / 600x300 / 400x600 / 600x400. Color: negro. Accesorios incluidos. Compatible con todas las marcas. Apto para pantallas planas. Material: acero y plástico. Fácil instalación. Cable: 1.5M. Entrada: 100~240V. Salida: 29V, 1.8A.

Referencia	Tipo	Peso máximo	Embalaje
500057004	Motorizado elevable	60Kg./ 132lbs	2

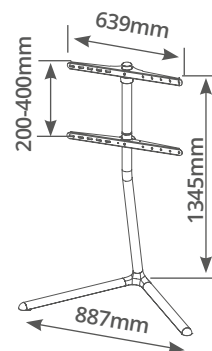

HOLMIOS®

Soporte de pie fijo 49" - 70"

Sistema de anclaje universal **VESA 200x200 / 300x200 / 300x300 / 400x200 / 400x300 / 400x400 / 600x400**.
Indicador de dirección. Organizador de cables. Color: negro. Accesorios incluidos.
Compatible con todas las marcas. Material: **acero, aluminio y plástico**. Fácil instalación.

Referencia	Tipo	Peso máximo	Altura máxima	Embalaje
500060000	Fijo	40Kg. / 88lbs	1345mm	2

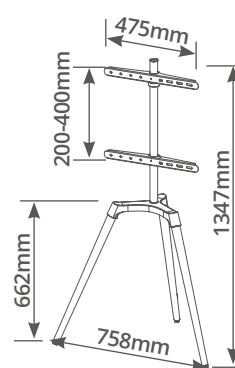

HOLMIOS®

Soporte de pie tipo trípode 50" - 65"

Sistema de anclaje universal **VESA 200x200 / 300x200 / 300x300 / 400x200 / 400x300 / 400x400**.
Giro: ±70°. Indicador de dirección. Organizador de cables. Color: negro. **Patas de madera**. Accesorios incluidos.
Compatible con todas las marcas. Material: **acero, aluminio y plástico**. Fácil instalación.

Referencia	Tipo	Peso máximo	Altura máxima	Embalaje
500060001	Trípode	35Kg. / 77lbs	1347mm	2



Accesorio estante
(se vende por separado)

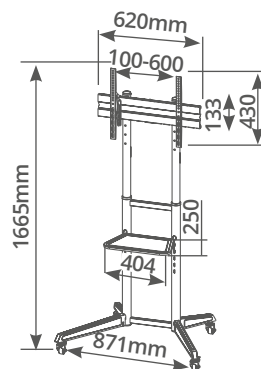
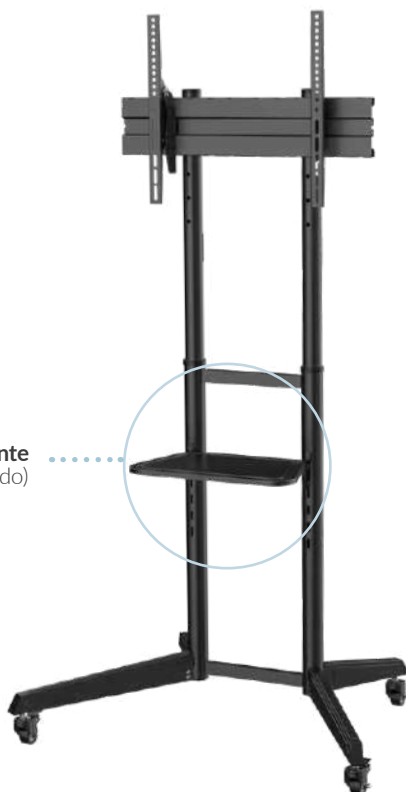

Soporte de pie con ruedas 37" - 70"



Sistema de anclaje universal **VESA 100x100 / 200x100 / 200x200 / 300x200 / 300x300 / 400x200 / 400x300 / 400x400 / 600x400**. Rotación: +5° -12°. Organizador de cables. Color: negro. Accesorios incluidos. Compatible con todas las marcas. Material: **acero, aluminio y plástico**. Fácil instalación.

Referencia	Tipo	Peso máximo	Posiciones	Embalaje
500060003	De pie con ruedas	50Kg. / 110lbs	4 (Fijas)	1
500060004	Estante para accesorios para soporte TV ref. 500060003			

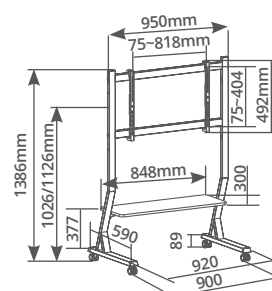

Soporte de pie con ruedas 45" - 90"



Sistema de anclaje universal **VESA 200x100 / 100x200 / 100x100 / 200x200 / 75x75 / 300x200 / 400x200 / 300x300 / 400x300 / 400x400 / 600x400 / 800x400**. Peso máximo estantería: 10Kg.
 Color: negro. Accesorios incluidos. Compatible con todas las marcas. Material: **acero y plástico**. Fácil instalación.

Referencia	Tipo	Peso máximo	Embalaje
500060005	De pie con ruedas	60Kg. / 132lbs	1

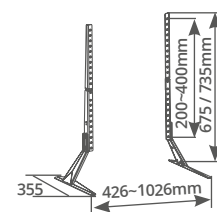

HOLMIOS®

Soporte patas sobremesa para TV 23" - 75"

Sistema de anclaje universal **VESA 200x200 / 300x200 / 400x200 / 300x300 / 400x300 / 400x400 / 600x400 / 800x400**.
 Color: negro. Accesorios incluidos. Compatible con todas las marcas. Material: **acero y plástico**. Fácil instalación.

Referencia	Tipo	Peso máximo	Embalaje
500060006	Patas para televisor / pantalla	40Kg./88lbs	8

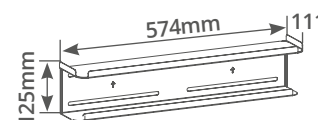

HOLMIOS®

Soporte trasero para accesorios de TV

Con **base antideslizante**. Para TV sin soporte. Material: **acero**. Fácil instalación.

Referencia	Peso máximo	Color	Embalaje
500090006	2Kg./4lbs	● Negro	10





A



B

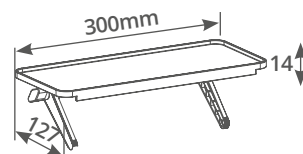
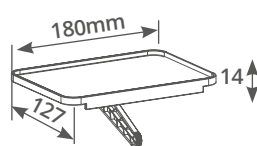

HOLMIOS®

Estante para accesorios de TV

Instalación con perilla. Color: negro. Material: plástico. Compatible con todas las marcas. Fácil instalación.

Referencia	Artículo	Tipo	Peso máximo	Color	Embalaje
500090004	A	Simple	6Kg. / 13lbs	● Negro	40
500090005	B	Doble	6Kg. / 13lbs	● Negro	20

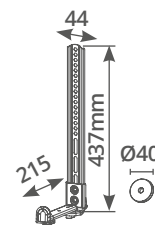

HOLMIOS®

Soporte barra de sonido

Anchura regulable: 40-182mm. Para barras de sonido de: 580-1143mm. Distancia entre barras: 77-215mm. Montaje sobre o bajo la TV. Accesorios incluidos. Material: acero y plástico. Fácil instalación.

Referencia	Peso máximo	Color	Embalaje
500091000	15Kg. / 33lbs	● Negro	10



Soportes pantallas

Soportes



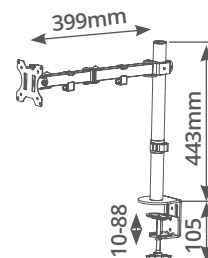

HOLMIOS®

Soporte brazo articulado 13" - 32"

Sistema de anclaje universal **VESA 75x75 / 100x100**. Color: negro.

Rotación ±360°. **Brazo regulable**. Compatible con todas las marcas. Material: **acero**. Fácil instalación.

Referencia	Tipo	Peso máximo	Inclinación	Oscilación	Embalaje
500080003	Brazo inclinable	8Kg. / 17.6lbs	Arriba / Abajo ±45°	Lateral ±90°	1

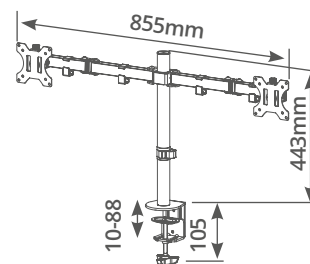

HOLMIOS®

Soporte brazo articulado 13" - 32"

Sistema de anclaje universal **VESA 75x75 / 100x100**. Color: negro.

Rotación ±90°. **Brazo regulable**. Compatible con todas las marcas. Material: **acero**. Fácil instalación.

Referencia	Tipo	Peso máximo	Inclinación	Oscilación	Embalaje
500080004	Brazo doble inclinable	8Kg. / 17.6lbs	Arriba / Abajo ±45°	Lateral ±180°	1

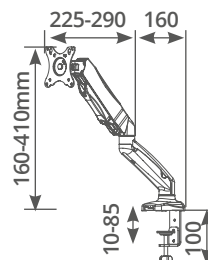

Soporte brazo articulado 13" - 27"

HOLMIOS®

Sistema de anclaje universal **VESA 75x75 / 100x100**. Color: negro. Con **amortiguador de gas**. **Rotación ±360°**. **Brazo regulable**. Compatible con todas las marcas. Material: **acero**. Fácil instalación.

Referencia	Peso máximo	Inclinación	Oscilación	Embalaje
500080005	6.5Kg. / 14.3lbs	Arriba / Abajo ±45°	Lateral ±90°	1

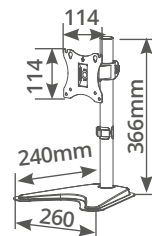

Soporte TV / monitor 17" - 27"

HOLMIOS®

Sistema de anclaje universal **VESA 75x75 / 100x100**. Color: negro. **Rotación: ±180°**. **Altura regulable**. Compatible con todas las marcas. Material: **acero y plástico**. Fácil instalación.

Referencia	Tipo	Peso máximo	Inclinación	Oscilación	Embalaje
500080006	Para TV / Monitores	7Kg. / 15lbs	Arriba / Abajo ±10°	Lateral ±45°	10



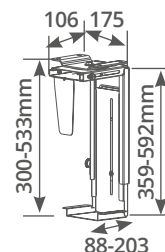

Soporte CPU bajo mesa ajustable



Rotación: 360°. Color: negro. Material: **acero**. Fácil instalación.

Referencia	Peso máximo	Altura regulable	Profundidad regulable	Embalaje
500080008	10Kg. / 22lbs	300-533mm	88-203mm	6

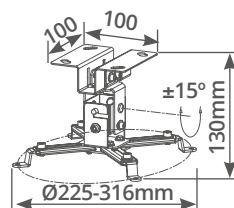
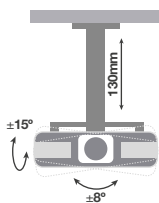

Soporte techo para proyector



Altura: 130mm. Color: negro.
Compatible con todas las marcas. Material: **acero**. Fácil instalación.

Referencia	Tipo	Peso máximo	Inclinación	Oscilación	Embalaje
500075000	Para proyector	20Kg. / 44lbs	Arriba / Abajo ±15°	Lateral ±8°	10

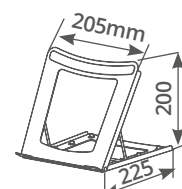

Soporte elevador portátil

HOLMIOS®

Con 3 posiciones: 15° / 45° / 60°. Mecanismo de plegado. Compatible con todas las marcas. Base con silicona antideslizante. Material: **acero**.

Referencia	Tamaño	Peso máximo	Embalaje
500080009	De 10" a 15"	5Kg. / 11lbs	20

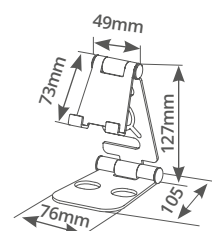

Soporte móvil/tablet multiángulo plegable

HOLMIOS®

Mecanismo de plegado. Compatible con todas las marcas. Base con silicona antideslizante. Ideal para tablets, móviles y relojes. Material: **acero**.

Referencia	Tamaño	Peso máximo	Embalaje
500090007	Máx. 10"	5Kg. / 11lbs	100

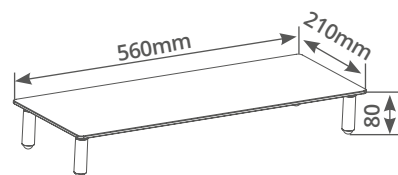

HOLMIOS®

Soporte elevador de monitor

Almohadillas antideslizantes. Material: **ABS y vidrio**. Fácil instalación.

Referencia	Peso máximo	Color	Embalaje
500080000	20Kg. / 44lbs	○ Transparente	5
500080001	20Kg. / 44lbs	● Negro	5

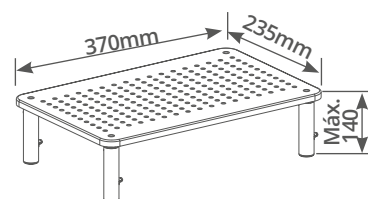
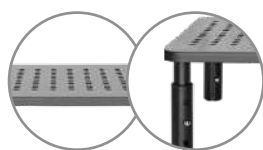

HOLMIOS®

Soporte metálico elevador de monitor

Superficie **ventilada y resistente**. Almohadillas antideslizantes. Material: **acero y plástico**. Fácil instalación.

Referencia	Peso máximo	Altura regulable	Color	Embalaje
500080002	20Kg. / 44lbs	100mm / 120mm / 140mm	● Negro	14



Soportes hogar y oficina

Soportes



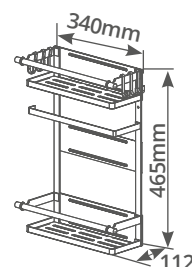

HOLMIOS®

Organizador objetos con imán electrodomésticos

Instalación con imanes. Material: **acero**. Fácil y rápida instalación.

Referencia	Peso máximo	Embalaje
500090002	12Kg. / 26.4lbs	5

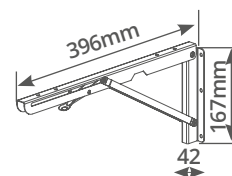

HOLMIOS®

Escuadra estante

Plegable. Distancia entre brazos: 400-800mm. Material: **acero**. Fácil instalación.

Referencia	Peso máximo	Color	Embalaje
500090003	50Kg. / 110lbs	○ Blanco	15

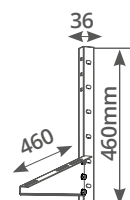
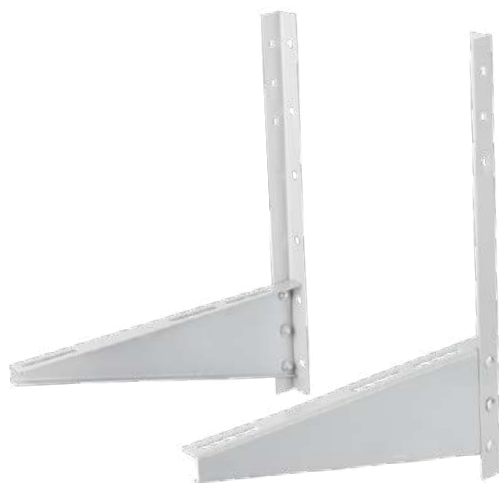

HOLMIOS®

Soporte pared para **aire acondicionado**

Distancia entre brazos: 400-800mm. **Para aire 1-2HP.** Material: **SPCC acero.** Fácil instalación.

Referencia	Peso máximo	Color	Embalaje
500085001	200Kg./ 440lbs	○ Blanco	15

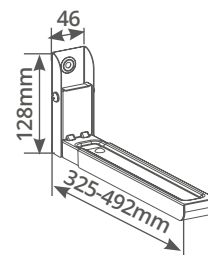
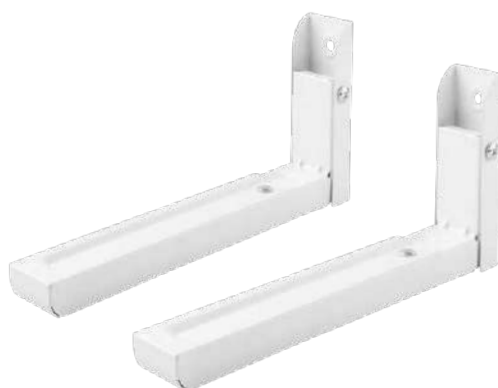

HOLMIOS®

Soporte pared para **microondas**

Pie extensible: 325-492mm. **Plegable** 130mm. Material: **acero.** Fácil instalación.

Referencia	Peso máximo	Color	Embalaje
500085000	30Kg./ 66lbs	○ Blanco	15



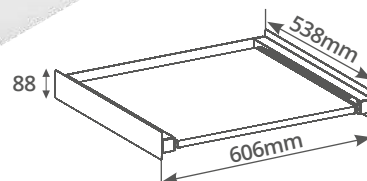

HOLMIOS®

Soporte unión lavadora y secadora

Bandeja extraíble 8Kg. Material: **acero y aluminio**. Fácil instalación.

Referencia	Peso máximo	Color	Embalaje
500090000	60Kg. / 132lbs	○ Blanco	1

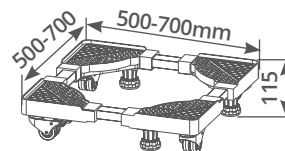

HOLMIOS®

Soporte multifuncional con ruedas

Anchura regulable: 500-700mm. Material: **plástico + acero inoxidable**. Fácil instalación.

Referencia	Peso máximo	Color	Embalaje
500090013	300Kg. / 662lbs	○ Blanco	5

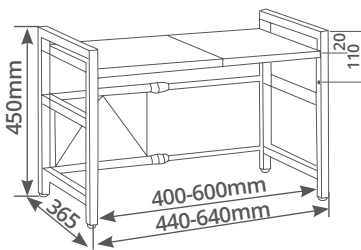

Estante organizador de cocina

HOLMIOS®

Anchura regulable: 400-600mm. Con 2 niveles para colocar estante. Material: **acero**. Incluye **8 colgadores**. Soporte ideal para colocar microondas. Fácil y rápida instalación.

Referencia	Peso máximo	Color	Embalaje
500090011	20Kg. / 44lbs	● Negro	5
500090012	20Kg. / 44lbs	○ Blanco	5



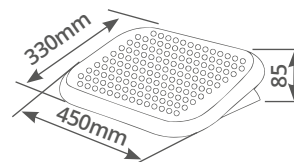

HOLMIOS®

Reposapiés ergonómico plataforma ajustable

Ajuste **inclinación mediante presión**. Material: plástico. Diseño ergonómico. Reduce la fatiga. **Superficie antideslizante**. Color negro. Ideal para oficina.

Referencia	Plataforma	Peso máximo	Ángulo inclinación	Embalaje
500090008	Ajustable	25Kg./ 55lbs	0° - 15°	5

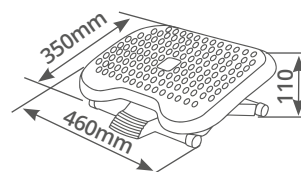

HOLMIOS®

Reposapiés ergonómico ajustable en ángulo y altura

Ajuste **inclinación mediante palanca**. Material: plástico. Diseño ergonómico. Reduce la fatiga. **Superficie antideslizante**. Color negro. Ideal para oficina.

Referencia	Ajustable	Peso máximo	Ángulo inclinación	Embalaje
500090009	En ángulo y altura	25Kg./ 55lbs	0° - 30°	5

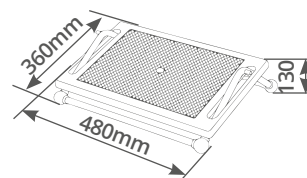

Reposapiés ergonómico **acero** plataforma ajustable



Ajuste **inclinación mediante presión**. Material: **acero** + plástico. Diseño ergonómico. Reduce la fatiga. **Superficie antideslizante**. Color negro. Ideal para oficina.

Referencia	Plataforma	Peso máximo	Ángulo inclinación	Embalaje
500090010	Ajustable	25Kg./ 55lbs	0° - 15°	5

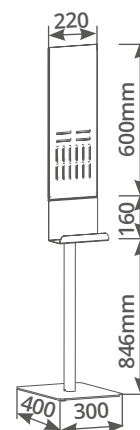

Soporte dispensador **gel hidroalcohólico**



Ideal para centros comerciales, restaurantes y otras áreas de alto tráfico. **Bandeja antigoteo**. Material: **acero y plástico**. Fácil instalación.

Referencia	Peso máximo	Color	Embalaje
500090001	5Kg./ 11lbs	○ Blanco	1





Ventilación

Climatización



Ladoli

VENTILADOR

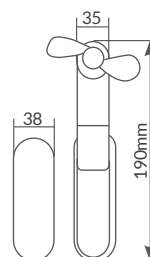

Mini ventilador de mano plegable

Display 6 unidades.

Conexión cable USB 0.8M. Material: ABS. Función powerbank.

Referencia	Potencia	Batería	Colores	Embalaje
300010033	0.5W	3.7V / 1500mAh	Blanco, rosa y verde	6/24

Ventilación De mano y USB

Suwa

VENTILADOR



Mini ventilador de agua

Material: ABS + PVC. 2 aspas transparentes.
Funciona con pilas (no incluidas).

Referencia	Capacidad	Pilas	Embalaje
300010016	300ml	2 x AA	12

Balu

VENTILADOR



CHARGING
USB

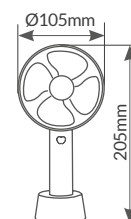

Mini ventilador de mano USB

Botón On/Off. Conexión cable USB 0.8M.
Rejilla de protección. 4 aspas. DC 5V.

Referencia	Potencia (máx.)	Color	Velocidades	Decibelios (máx.)	Embalaje
300010023	5W	○ Blanco	3	58dB	20
300010024	5W	● Negro	3	58dB	20

Salara

VENTILADOR



CHARGING
USB

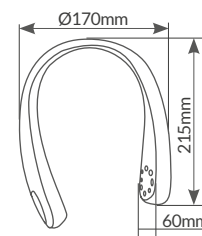

Ventilador de cuello portátil USB

Botón On/Off. Conexión micro cable USB 0.8M.
Autonomía: 3-6h. Tiempo de carga: 3-4h. Incluye batería de 1800mAh.

Referencia	Potencia (máx.)	Color	Velocidades	Embalaje
300010034	3.5W	○ Blanco	3	20

Bhari

VENTILADOR



CHARGING
USB

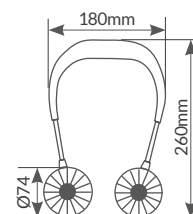

Ventilador de cuello portátil USB

Botón On/Off. Conexión micro cable USB 0.5M.

Autonomía: 3-6h. Tiempo de carga: 3-4h. Incluye batería de litio 18650 (reemplazable).

Referencia	Potencia (máx.)	Color	Velocidades	Embalaje
300010035	2.5W	● Negro / Azul	3	40

Kila

VENTILADOR



USB

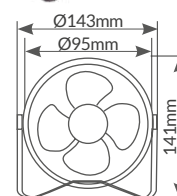

Mini ventilador sobremesa USB

Ángulo de inclinación de 180°. Conexión cable USB 1.1M.

Rejilla de protección. 4 aspas metálicas. Motor: DC. DC 5V.

Referencia	Potencia (máx.)	Color	Decibelios (máx.)	Embalaje
005000720	2.5W	● Negro	40dB	45
005000729	2.5W	● Gris	40dB	45
300010018 ★	2.5W	● Cobre	40dB	45

Alua

VENTILADOR

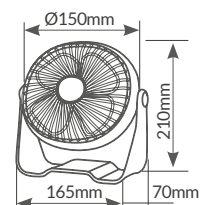

Mini ventilador sobremesa USB

Ángulo de inclinación 360°. Conexión cable USB 1.2M.
Material: PP. Rejilla de protección. Motor: DC. DC 5V.

Referencia	Potencia (máx.)	Color	Velocidades	Decibelios (máx.)	Embalaje
300010019	3W	○ Blanco	2	40dB	28
300010020	3W	● Aguamarina	2	40dB	28
300010030 ★	3W	● Negro	2	40dB	28
300010031 ★	3W	● Coral	2	40dB	28

Tapri

VENTILADOR



USB

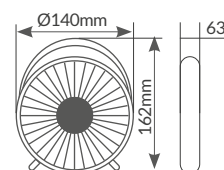

Mini ventilador sobremesa USB

Pata inclinables. Conexión cable USB 0.8M.

Material: **ABS + PP.** Rejilla de protección. 3 aspas. DC 5V. Motor: **DC.** IPX0.

Referencia	Potencia (máx.)	Color	Velocidades	Decibelios (máx.)	Embalaje
300010028	5W	○ Blanco	1	<45dB	36
300010029	5W	● Negro	1	<45dB	36

Fune

VENTILADOR



USB

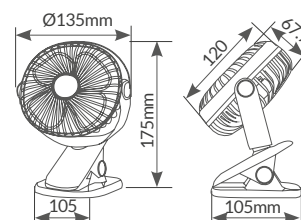

Mini ventilador USB tipo clip

Ángulo de inclinación regulable. Conexión cable USB 1.2M.

Rejilla de protección. 5 aspas plástico. DC 5V.

Referencia	Potencia (máx.)	Color	Velocidades	RPM (máx.)	Flujo (máx.)	Decibelios (máx.)	Embalaje
300010021	3W	○ Blanco	2	2350rpm	4.2m ³ /min	45dB	20
300010032 ★	3W	● Negro	2	2350rpm	4.2m ³ /min	45dB	20

Box fan

VENTILADOR



Temporizador
120min.

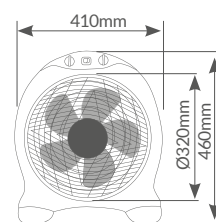

Ventilador box fan

Con **temporizador** hasta 120min. Cable: 1.6M.
Con **difusor rotatorio** y rejilla de protección. 220-240V.

Referencia	Potencia (máx.)	Velocidades	RPM (máx.)	Flujo (máx.)	Decibelios (máx.)	Embalaje
005000700	50W	3	1250rpm	33.01m ³ /min	60.3dB	1

Behda

VENTILADOR



Temporizador
120min.

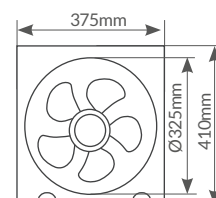

Ventilador box fan

Con **temporizador** hasta 120min. Cable: 1.6M.
Con **difusor rotatorio** y rejilla de protección. 220-240V.

Referencia	Potencia (máx.)	Velocidades	RPM (máx.)	Flujo (máx.)	Decibelios (máx.)	Embalaje
300030003	45W	3	1250rpm	23.77m ³ /min	58dB	1

Lindi

VENTILADOR

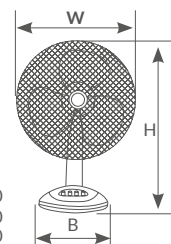

WxH / B (mm)
 30W Ø230x350 / Ø210
 40W Ø340x490 / Ø270
 45W Ø430x550 / Ø270

Ventilador sobremesa

2 posiciones: **fijo y rotatorio**. **Difusor oscilante 90°**.
 Ángulo de **inclinación** de 10°. Rejilla de protección. Cable: 1.6M. 220-240V.

Referencia	Potencia (máx.)	Color	Veloc.	RPM (máx.)	Flujo (máx.)	Decibelios (máx.)	Embalaje
005000728	30W	○ Blanco	2	1250rpm	16.5m ³ /min	49.1dB	1
005000701	40W	○ Blanco	3	1250rpm	40.24m ³ /min	49.36dB	1
300010017	40W	● Negro	3	1250rpm	40.24m ³ /min	49.36dB	1
005000702	45W	○ Blanco	3	1250rpm	78.65m ³ /min	53.38dB	1



Macomia

VENTILADOR

Ventilación Sobremesa

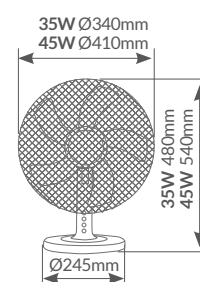

Ventilador sobremesa

2 posiciones: **fijo y rotatorio**. **Difusor oscilante 80°**.
 Ángulo de **inclinación** de 15°. Rejilla de protección. Cable: 1.6M. 220-240V.

Referencia	Potencia (máx.)	Color	Veloc.	RPM (máx.)	Flujo (máx.)	Decibelios (máx.)	Embalaje
300010012	35W	○ Blanco	3	1150rpm	25.75m ³ /min	49.2dB	1
300010013	35W	● Negro	3	1150rpm	25.75m ³ /min	49.2dB	1
300010014	45W	○ Blanco	3	1150rpm	40.56m ³ /min	51dB	1
300010015	45W	● Negro	3	1150rpm	40.56m ³ /min	51dB	1

Toleni

VENTILADOR

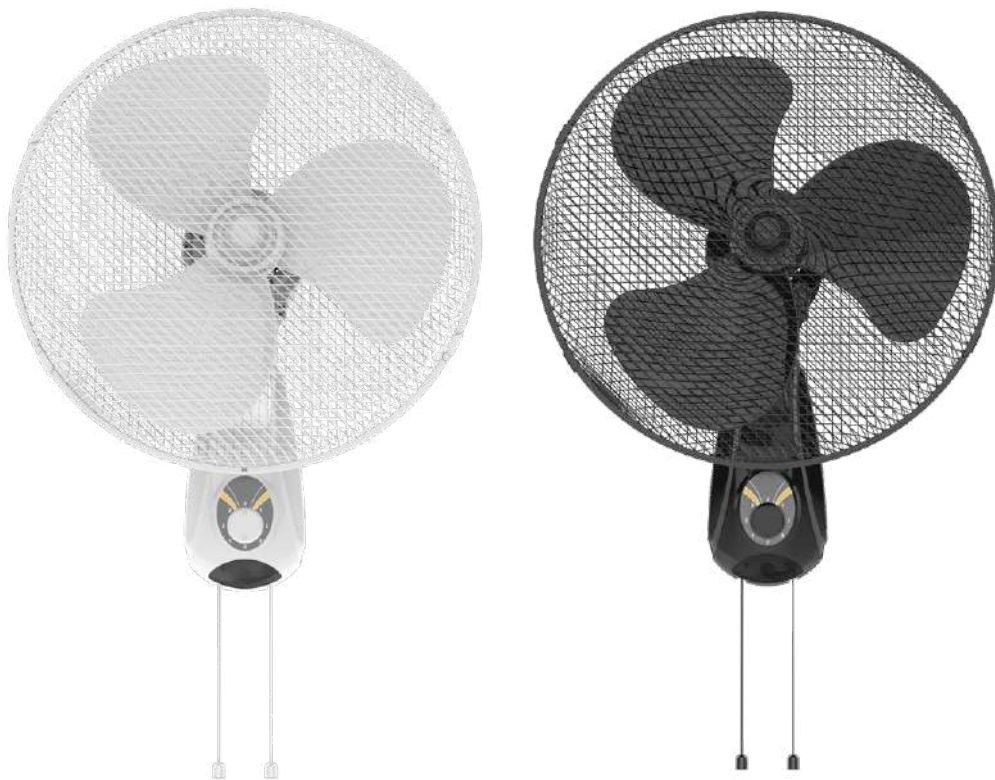

Ventilación De pared

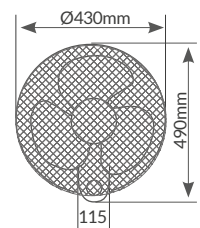

Ventilador de pared

Difusor oscilante 90°. Con cabezal oscilante **multiorientable**.

Interruptor mediante cuerda. Ángulo de **inclinación** de 10°. Rejilla de protección. 220-240V.

Referencia	Potencia (máx.)	Color	Velocidades	RPM (máx.)	Flujo (máx.)	Decibelios (máx.)	Embalaje
005000706	45W	○ Blanco	3	1250rpm	69.84m³/min	51.99dB	1
300010025 ★	45W	● Negro	3	1250rpm	69.84m³/min	51.99dB	1



Sautar

VENTILADOR

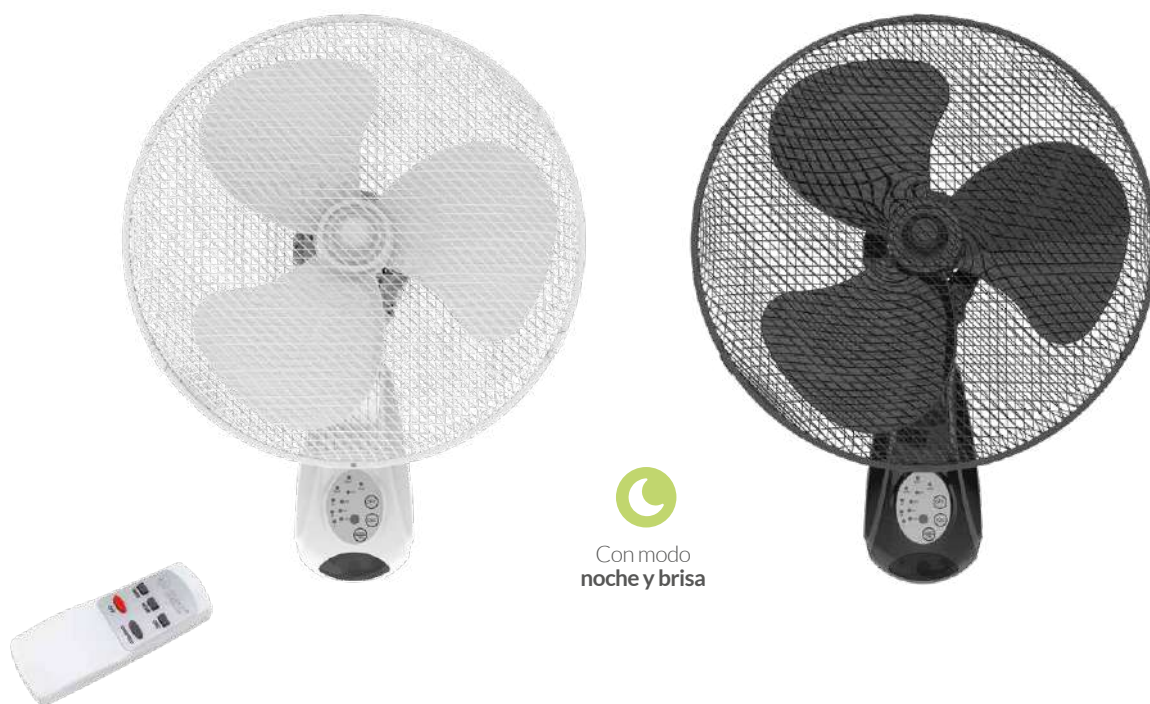

Con modo
noche y brisa

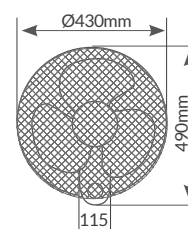

Ventilador de pared + mando

Con **mando a distancia** (pilas no incluidas). **Difusor oscilante 90°**.

Modo noche y brisa. Con cabezal oscilante **multiorientable**. Con **temporizador** de hasta 7.5h.

Ángulo de **inclinación** de 10°. Rejilla de protección. 220-240V.

Referencia	Potencia (máx.)	Color	Velocidades	RPM (máx.)	Flujo (máx.)	Decibelios (máx.)	Embalaje
005000732	45W	○ Blanco	3	1250rpm	70.02m ³ /min	51.99dB	1
300010026 ★	45W	● Negro	3	1250rpm	70.02m ³ /min	51.99dB	1

Barsi

VENTILADOR

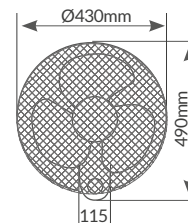

Ventilador de pared + mando

Con **mando a distancia** (pilas no incluidas). **Difusor oscilante** 90°. **Modo noche**. Con **temporizador** de hasta 7.5h. Material: **PP**. Ángulo de **inclinación** de 10°. Rejilla de protección. Cable: 1.6M. 220-240V.

Referencia	Potencia (máx.)	Color	Velocidades	RPM (máx.)	Flujo (máx.)	Decibelios (máx.)	Embalaje
300010027	50W	○ Blanco	3	1250rpm	70.98m³/min	53.48dB	1

Ventilación De pared

Palogi

VENTILADOR

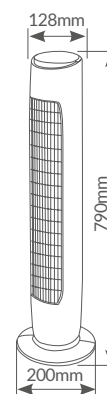

Ventilador de torre

2 posiciones: **fijo y rotatorio**. **Difusor oscilante** 70°. Con **temporizador** de hasta 2h. Rejilla de protección. 220-240V.

Referencia	Potencia (máx.)	Velocidades	RPM (máx.)	Flujo (máx.)	Decibelios (máx.)	Embalaje
300025000	45W	3	1350rpm	22.8m³/min	55dB	1



Nandi

VENTILADOR

Ventilación De pie

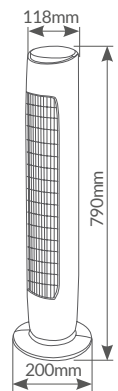

Ventilador de torre + mando

2 posiciones: **fijo y rotatorio**. **Difusor oscilante 70°**. Material: **ABS + PP**.
Con **temporizador** de hasta 3h. Indicador luminoso LED. Rejilla de protección. Cable: 1.5M. 220-240V. IPX0.

Referencia	Potencia (máx.)	Color	Velocidades	RPM (máx.)	Flujo (máx.)	Decibelios (máx.)	Embalaje
300025003 ★	45W	○ Blanco	3	1350rpm	22.8m ³ /min	55dB	1
300025001	45W	● Negro	3	1350rpm	22.8m ³ /min	55dB	1

Kodima

VENTILADOR

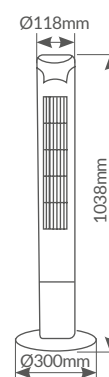

Ventilador de torre + mando

2 posiciones: **fijo y rotatorio**. **Difusor oscilante** 70°. Material: **ABS + PP**.
Panel de control LED y **botones táctiles**. Con **temporizador** de hasta 12h.
Indicador luminoso LED. Rejilla de protección. Cable: 1.5M. 220-240V. IPX0.

Referencia	Potencia (máx.)	Color	Velocidades	RPM (máx.)	Flujo (máx.)	Decibelios (máx.)	Embalaje
300025004	45W	○ Blanco	3	1350rpm	22.68m ³ /min	≤55dB	1
300025005	45W	● Negro	3	1350rpm	22.68m ³ /min	≤55dB	1

Nametil

VENTILADOR



Patas más alargadas
para mayor estabilidad

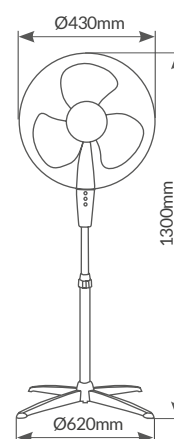

Ventilador de pie

2 posiciones: **fijo y rotatorio**.

Cabezal oscilante 90°. Ángulo de **inclinación** de 10°.

Rejilla de protección. Altura regulable. 220-240V.

Referencia	Potencia (máx.)	Color	Velocidades	RPM (máx.)	Flujo (máx.)	Decibelios (máx.)	Embalaje
300000015	45W	○ Blanco	3	1250rpm	70.98m ³ /min	53.48dB	1
300000027 ★	45W	● Negro	3	1250rpm	70.98m ³ /min	53.48dB	1

Khela

VENTILADOR

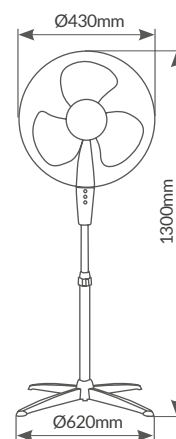
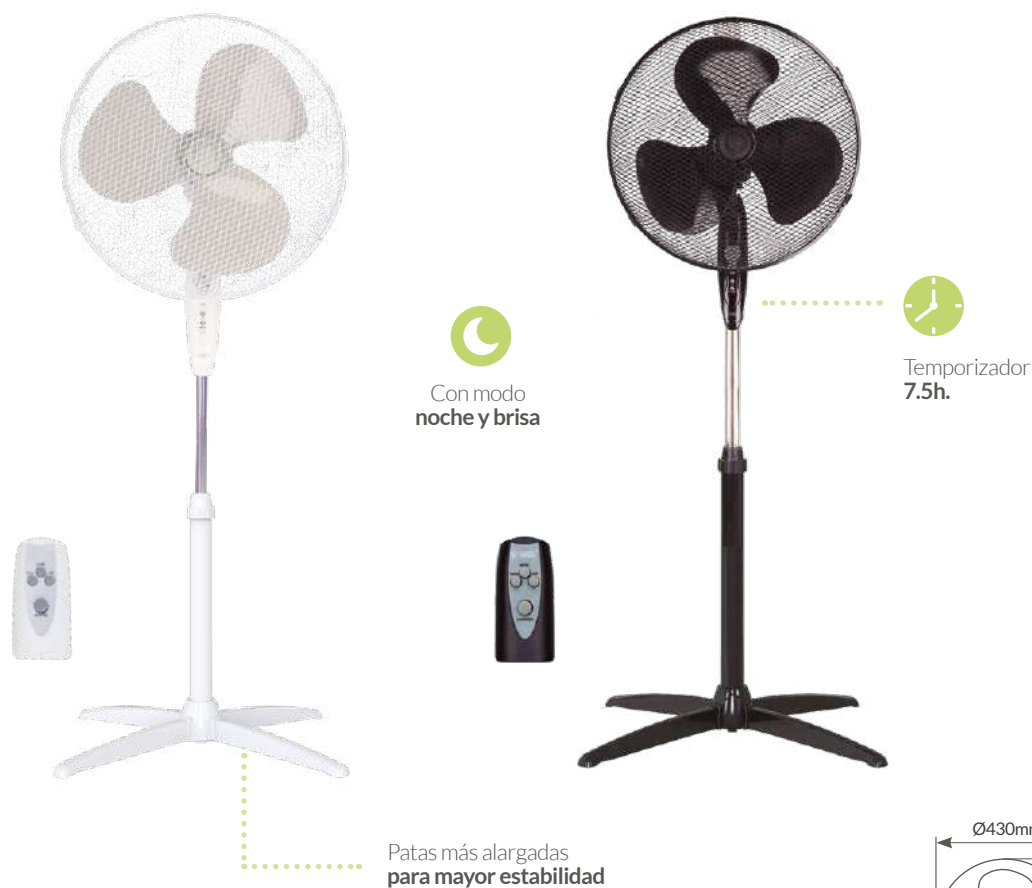

Ventilador de pie + mando

Con **mando a distancia**. 2 posiciones: **fijo y rotatorio**.
Difusor oscilante 90°. Con **temporizador** de hasta 7.5h.
 Con cabezal oscilante **multiorientable**. Ángulo de **inclinación** de 10°.
 Rejilla de protección. Altura regulable. El mando utiliza 2 pilas AAA (pilas no incluidas). 220-240V.

Referencia	Potencia (máx.)	Color	Velocidades	RPM (máx.)	Flujo (máx.)	Decibelios (máx.)	Embalaje
300000016	45W	○ Blanco	3	1250rpm	70.98m ³ /min	53.48dB	1
300000017	45W	● Negro	3	1250rpm	70.98m ³ /min	53.48dB	1



Kureli

VENTILADOR



Ventilación De pie

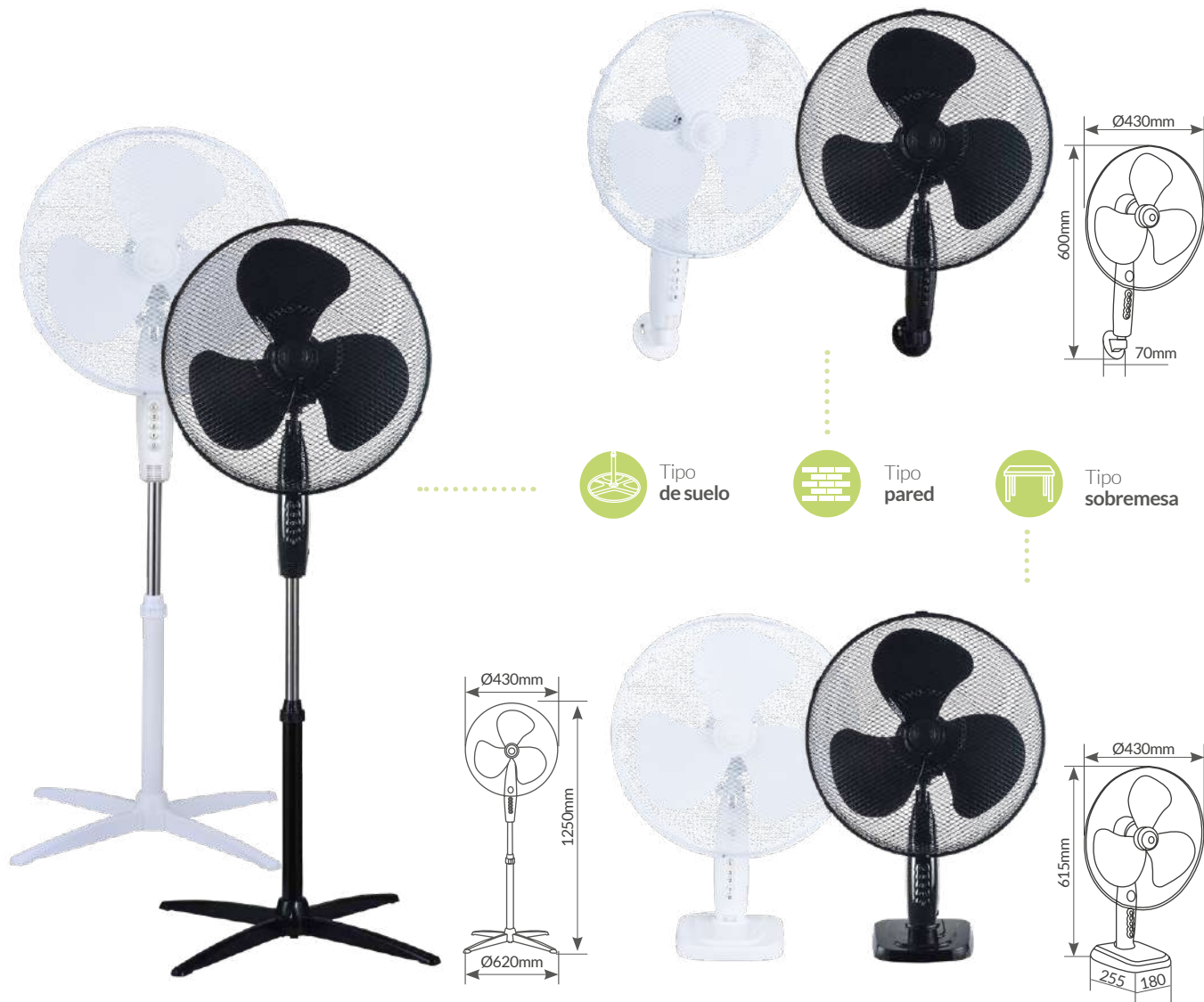

Ventilador 3 en 1

2 posiciones: **fijo y rotatorio.**

Difusor oscilante 90°. Con **temporizador** de hasta 7.5h.

Con cabezal oscilante **multiorientable.** Ángulo de **inclinación** de 10°.

Rejilla de protección. Altura regulable. 220-240V.

Referencia	Potencia (máx.)	Color	Velocidades	RPM (máx.)	Flujo (máx.)	Decibelios (máx.)	Embalaje
30000021	45W	○ Blanco	3	1250rpm	70.98m³/min	53.48dB	1
30000022	45W	● Negro	3	1250rpm	70.98m³/min	53.48dB	1

Lungra

VENTILADOR

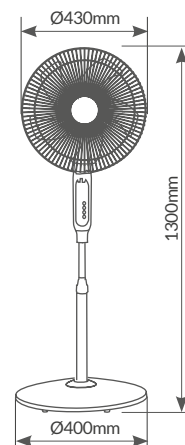
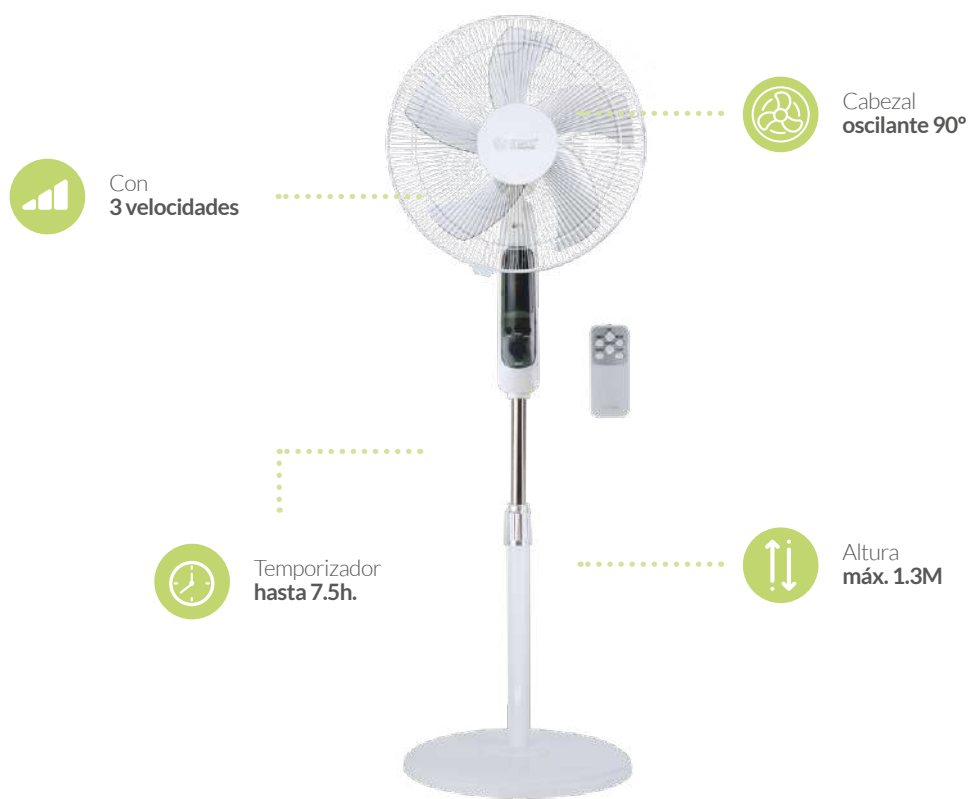

Ventilador de pie + mando

2 posiciones: **fijo y rotatorio**. **Cabezal oscilante 90°**. 5 aspas.
 Con **temporizador** hasta **7.5h**. Material: **PP**. Ángulo de **inclinación** regulable 10°.
 Rejilla de protección. Base redonda. Altura regulable. Cable: 1.6M. 220-240V.

Referencia	Potencia (máx.)	Color	Velocidades	RPM (máx.)	Flujo (máx.)	Decibelios (máx.)	Embalaje
300000023	50W	○ Blanco	3	1250rpm	70.98m ³ /min	53.48dB	1

Tehri

VENTILADOR



Con **9 velocidades**



Modos de viento: **natural, normal y modo noche**



Bajo consumo de **4W a 30W**



Temporizador hasta **24h.**



Motor **DC**



Silencioso apenas hace ruido **31dB** a velocidad 1

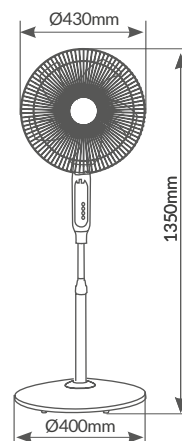

Ventilador de pie + mando motor DC

2 posiciones: **fijo y rotatorio. Cabezal oscilante 90°**. 5 aspas.

3 modos de viento: normal, natural y modo noche. Material: **PP**. Ángulo de **inclinación** regulable 10°.

Base redonda. Rejilla de protección **tipo parrilla**. Altura regulable. Cable: 1.6M. **Motor DC 24V** conectado AC 220-240V.

Referencia	Potencia (máx.)	Color	Velocidades	RPM (máx.)	Flujo (máx.)	Decibelios (máx.)	Embalaje
300000020	30W	● Negro	9	1250rpm	57.2m ³ /min	51dB	1
300000028	30W	○ Blanco	9	1250rpm	57.2m ³ /min	51dB	1



Sandi

VENTILADOR

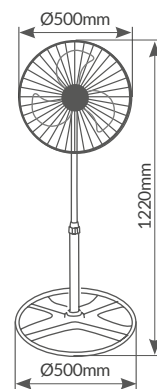

Ventilador metálico de pie

2 posiciones: **fijo y rotatorio. Cabezal oscilante 85°**.
Material: **ABS + metal**. Rejilla de protección. Altura regulable. Cable: 1.6M. 220-240V.

Referencia	Potencia (máx.)	Velocidades	RPM (máx.)	Flujo (máx.)	Decibelios (máx.)	Embalaje
005000721	70W	3	1249rpm	75.3m³/min	60.8dB	1

Lumbo

VENTILADOR



Temporizador
hasta 7.5h.

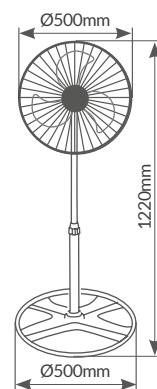

Ventilador metálico de pie + mando

2 posiciones: **fijo y rotatorio. Cabezal oscilante 85°**. Con **temporizador** hasta 7.5h.
Material: **ABS + metal**. Rejilla de protección. Altura regulable. Cable: 1.6M.
El mando utiliza 2 pilas AAA (pilas no incluidas). 220-240V.

Referencia	Potencia (máx.)	Velocidades	RPM (máx.)	Flujo (máx.)	Decibelios (máx.)	Embalaje
300000018	70W	3	1249rpm	75.3m³/min	60.8dB	1

Sassela

VENTILADOR

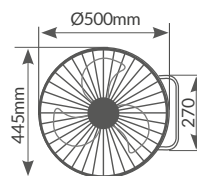

Tipo de suelo



Tipo pared



Tipo sobremesa

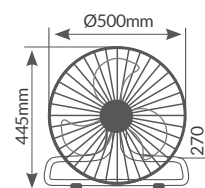
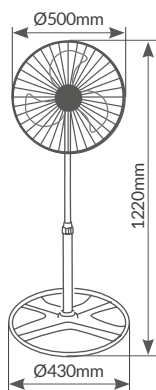

Ventilador metálico 3 en 1

2 posiciones: fijo y rotatorio. Cabezal oscilante 85°.
Material: **ABS + metal**. Rejilla de protección. Altura regulable. 220-240V.

Referencia	Potencia (máx.)	Velocidades	RPM (máx.)	Flujo (máx.)	Decibelios (máx.)	Embalaje
300000014	70W	3	1249rpm	75.3m³/min	60.8dB	1



Hukam

VENTILADOR



Ventilador vaporizador de pie

2 posiciones: **fijo y rotatorio. Cabezal oscilante 85° y multiorientable.**

Ángulo de **inclinación** suavemente regulable.

Temporizador regulable de 30min hasta 7.5 horas. Pantalla LED. Con mando a distancia.

Capacidad de agua 2L (nebulización durante 8 horas). **3 modos de viento: normal, natural y modo noche.**

Material: **ABS**. Rejilla de protección. Altura regulable. Cable: 1.6M. 220-240V.

Referencia	Potencia (máx.)	Velocidades	RPM (máx.)	Flujo (máx.)	Decibelios (máx.)	Embalaje
005000724	70W	3	1250rpm	40.19m ³ /min	50.3dB	1
300000002	Recambio mando a distancia					

Magma

VENTILADOR

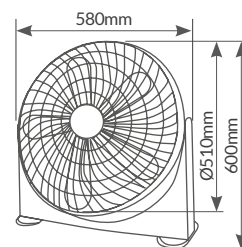

Ventilador industrial de suelo

Material: **plástico**. Ángulo de **inclinación** regulable 180°. Cable: 1.6M. 220-240V.

Referencia	Potencia (máx.)	Velocidades	RPM (máx.)	Flujo (máx.)	Decibelios (máx.)	Embalaje
005000733	90W	3	1100rpm	84.11m ³ /min	75.3dB	1

Thuwa

VENTILADOR

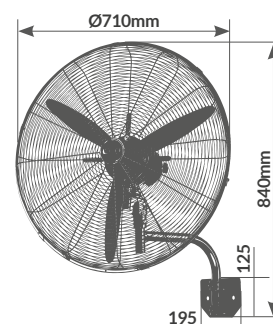

Ventilador metálico de pared

Aspas metálicas. **Cabezal oscilante** 85°. Ángulo de **inclinación** regulable 18°. Rejilla de protección reforzada. Cable: 1.6M. 220-240V.

Referencia	Potencia (máx.)	Velocidades	RPM (máx.)	Flujo (máx.)	Decibelios (máx.)	Embalaje
005000744	200W	3	1400rpm	184.63m ³ /min	72.3dB	1

Dalheri
VENTILADOR

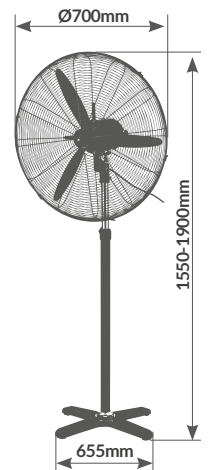
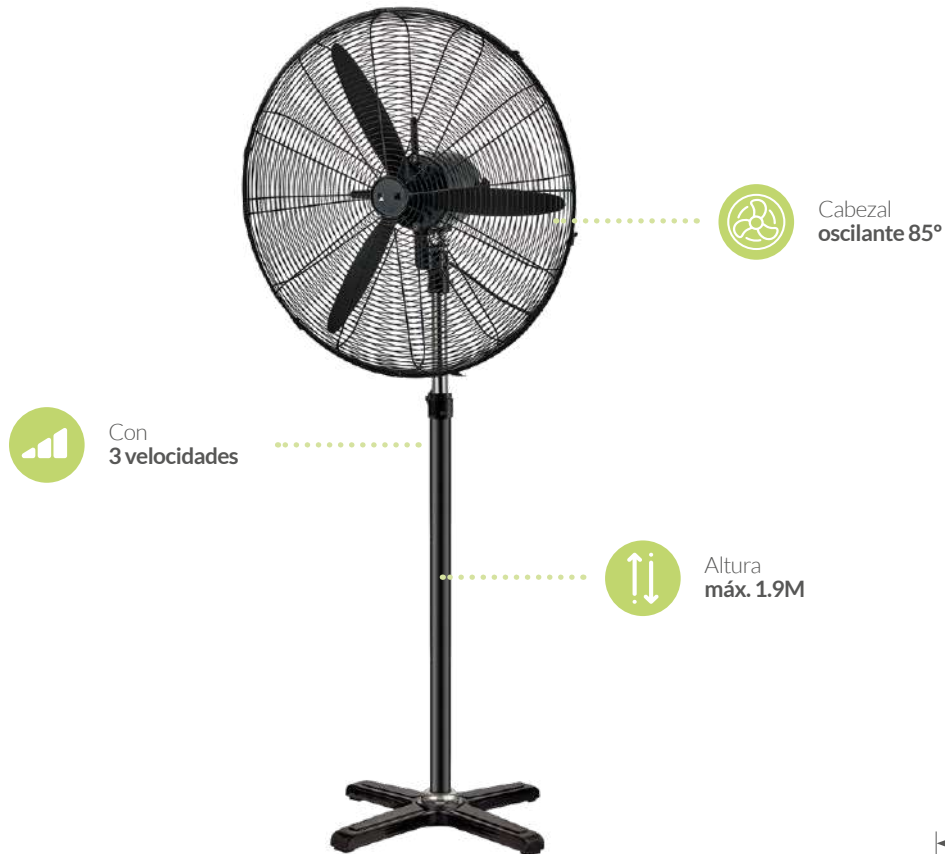

Ventilador metálico de pie

Aspas metálicas. **Cabezal oscilante** 85°. Ángulo de **inclinación** regulable 18°.
Rejilla de protección reforzada. Cable: 1.6M. 220-240V.

Referencia	Potencia (máx.)	Velocidades	RPM (máx.)	Flujo (máx.)	Decibelios (máx.)	Embalaje
005000745	200W	3	1400rpm	184.63m³/min	72.3dB	1

Mueda

VENTILADOR

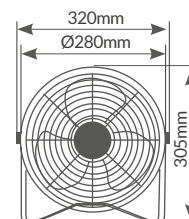

Ventilador metálico de suelo y pared

Aspas metálicas. Ángulo de **inclinación** regulable 120°.
Rejilla de protección reforzada. 220-240V.

Referencia	Potencia (máx.)	Velocidades	RPM (máx.)	Flujo (máx.)	Decibelios (máx.)	Embalaje
300030002	50W	3	1290rpm	21.04m ³ /min	54.2dB	1

Gumba

VENTILADOR

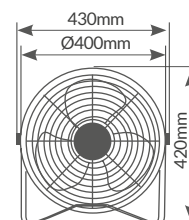

Ventilador metálico de suelo y pared

Ángulo de **inclinación** regulable 120°.
Aspas metálicas. Rejilla de protección reforzada. 230V.

Referencia	Potencia (máx.)	Velocidades	RPM (máx.)	Flujo (máx.)	Decibelios (máx.)	Embalaje
005000722	70W	3	1350rpm	46.5m ³ /min	61.2dB	1



Gumba

VENTILADOR

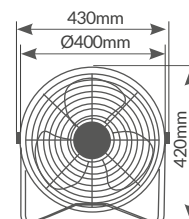

Ventilador metálico de suelo y pared

Aspas metálicas. Ángulo de **inclinación** regulable 120°.
Rejilla de protección reforzada. 220-240V.

Referencia	Potencia (máx.)	Velocidades	RPM (máx.)	Flujo (máx.)	Decibelios (máx.)	Embalaje
300030000	70W	3	1270rpm	46.5m ³ /min	61.2dB	1

Saruna

VENTILADOR

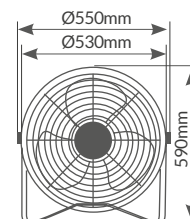

Ventilador metálico de suelo

Ángulo de **inclinación** regulable 120°.
Aspas metálicas. Rejilla de protección. Cable: 1.6M. 220-240V.

Referencia	Potencia (máx.)	Velocidades	RPM (máx.)	Flujo (máx.)	Decibelios (máx.)	Embalaje
005000743	120W	3	1350rpm	120m ³ /min	64dB	1

Netia

VENTILADOR

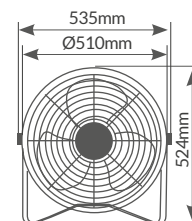

Ventilador metálico de suelo y pared

Aspas metálicas. Ángulo de **inclinación** regulable 120°.
Rejilla de protección reforzada. 220-240V.

Referencia	Potencia (máx.)	Velocidades	RPM (máx.)	Flujo (máx.)	Decibelios (máx.)	Embalaje
005000704	140W	3	1350rpm	88.2m ³ /min	67.9dB	1

Bampa

VENTILADOR

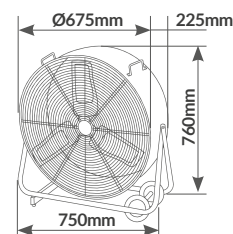

Ventilador metálico de suelo

Ángulo de **inclinación** regulable 270. Protección sobrecalentamiento.
Aspas metálicas. Rejilla de protección. **Con 2 ruedas**. Cable: 1.6M. 220-240V.

Referencia	Potencia (máx.)	Velocidades	RPM (máx.)	Flujo (máx.)	Decibelios (máx.)	Embalaje
005000746	250W	3	1150rpm	150.3m ³ /min	86.2dB	1

Horshi

DESHUMIDIFICADOR



Ventilación Purificación

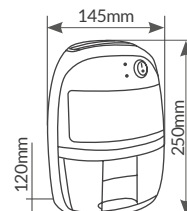

Deshumidificador Horshi

Ángulo de viento de 90°. Interruptor: On/Off. Indicador LED de depósito lleno.
 Material: **ABS.** Sistema de **autoapagado.** Adaptador AC/DC incluido. Portátil y compacto.
 Color: negro. Longitud cable: 1.5M. 100-240V.

Referencia	Potencia	Área cobertura	Capacidad	Decibelios (Máx.)	Embalaje
301505001	23W	20m ²	800ml.	34dB	8

Beteni

ENFRIADOR AIRE

USB

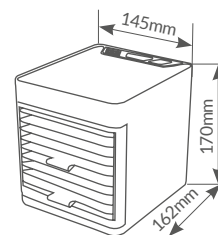

Enfriador de aire sobremesa 5W

Ángulo de viento de 90°. Conexión cable USB 1.5M. 3 velocidades: alta / media / baja.

Material: ABS. Autonomía vapor: 8h. (velocidad alta), 10h. (velocidad media), 12h. (velocidad baja).

Con 7 colores seleccionables de la luz. Rejilla de protección. Cajón extraíble, para un fácil acceso a los filtros.

Refresca, humidifica y purifica. Motor DC. DC 5V / 1A.

Referencia	Potencia	Velocidades	Capacidad	Decibelios (Máx.)	Embalaje
300010022	5W	3	660ml.	40dB	18

Tatasu

ENFRIADOR AIRE

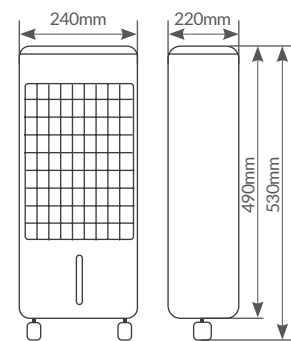

Enfriador de aire con mando y temporizador

Con mando a distancia. **Ángulo de viento de 90°**. 3 velocidades: alta / media / baja.
 Material: **PP**. **3 modos de viento: normal, natural y modo noche**.
 Con **temporizador** de hasta 15.5h. **Función oscilante** de la rejilla con el mando.
Refresca, humidifica y purifica. Cable: 1.5M. 220-240V.

Referencia	Potencia	Velocidades	Capacidad	Flujo (máx.)	Decibelios (Máx.)	Embalaje
300000026	80W	3	4L.	6.87m³/min	50.5dB	1

Larde

VENTILADOR

DC

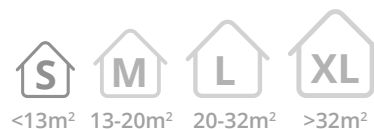
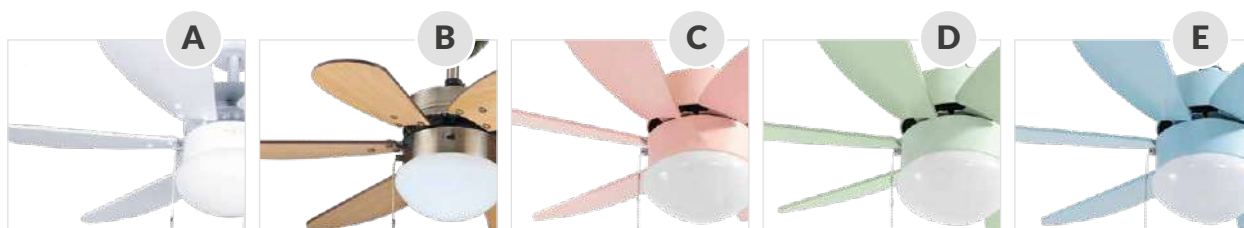

Incluye 2 tijas de 150mm y 250mm

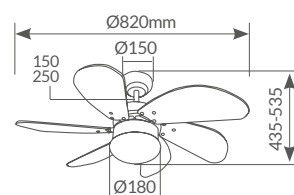

Ventilador de techo con luz Ø82cm

Con **6 aspas de contrachapado**. Utiliza 2 bombillas E27 (Máx. 2x20W). Interruptor mediante cuerda. Apto para **techos inclinados** hasta 25°. Motor **DC**. 220-240V. **32"**. IP20.

Referencia	Artículo	Potencia (máx.)	Veloc.	Color	RPM (máx.)	Flujo (máx.)	Decibelios (máx.)	Embalaje
300005075	A	2x20W	6	○ Blanco	200rpm	91m³/min	40dB	1
300005076	B	2x20W	6	● Haya	200rpm	91m³/min	40dB	1
300005077	C	2x20W	6	● Rosa	200rpm	91m³/min	40dB	1
300005078	D	2x20W	6	● Verde	200rpm	91m³/min	40dB	1
300005079	E	2x20W	6	● Azul	200rpm	91m³/min	40dB	1

Namuno

VENTILADOR



Modo verano



Modo invierno



<13m²



13-20m²



20-32m²



>32m²



Incluye 2 tijas de 150mm y 250mm

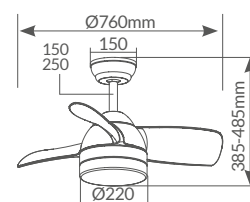

Ventilador de techo con luz Ø71cm

Con 3 aspas de ABS. Con temporizador: 1h., 2h., 4h. Con mando.

3 tonalidades de temperatura (3000K-4000-6500K).

LED reemplazable. Potencia luz: 15W. Lúmenes sin difusor: 1355Lm / 1534Lm / 1475Lm.

Apto para techos inclinados hasta 25°. Motor DC. 220-240V. 28". IP20.

Referencia	Artículo	Potencia (máx.)	Veloc.	Color	RPM (máx.)	Flujo (máx.)	Decibelios (máx.)	Embalaje
300005033	A	13W	6	○ Blanco	200rpm	210m ³ /min	40dB	1
300005052 ★	B	13W	6	● Blanco/Haya	200rpm	210m ³ /min	40dB	1
300005053 ★	C	13W	6	● Negro	200rpm	210m ³ /min	40dB	1
300015017	Recambio mando a distancia							



Kidau

VENTILADOR

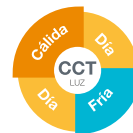

A



B

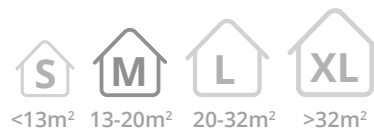

Incluye 2 tijas de 150mm y 250mm

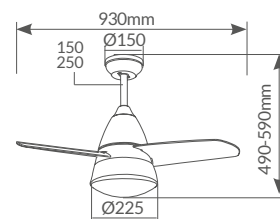

Ventilador de **techo con luz** Ø93cm

Con **3 aspas ABS**. Con **temporizador**: 1h., 2h., 4h., 8h. Con mando.
3 tonalidades de temperatura (3000K-4000-6500K).
LED reemplazable. Potencia luz: **15W**. Lúmenes sin difusor: **1355Lm / 1534Lm / 1475Lm**.
 Apto para **techos inclinados** hasta 25°. Motor AC. 220-240V. **36"**. IP20.

Referencia	Artículo	Potencia (máx.)	Veloc.	Color	RPM (máx.)	Flujo (máx.)	Decibelios (máx.)	Emb.
300005028	A	63W	3	○ Blanco	210rpm	120m³/min	50dB	1
300005049	★ B	63W	3	● Níquel	210rpm	120m³/min	50dB	1
300005014	Recambio mando a distancia							

Muna

VENTILADOR

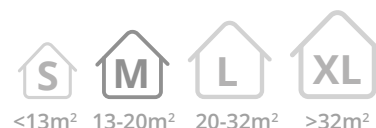

Incluye 2 tijas de 150mm y 250mm

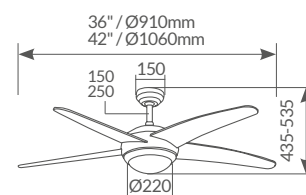

Ventilador de **techo con luz**

Con **4 aspas reversibles de contrachapado**. Con **temporizador**: 1h., 2h., 4h., 8h. Con mando.

3 tonalidades de temperatura (3000K-4000-6500K). LED reemplazable.

Potencia luz: **15W**. Lúmenes sin difusor: **1355Lm / 1534Lm / 1475Lm**.

Apto para **techos inclinados** hasta 25°. Motor AC. 220-240V. IP20.

Referencia	Potencia (máx.)	Veloc.	Diámetro / Pulgadas	Color	RPM (máx.)	Flujo (máx.)	Decibelios (máx.)	Emb.
300005038	63W	3	Ø91cm / 36"	● Blanco/Haya	230rpm	190m³/min	50dB	1
300005039	63W	3	Ø106cm / 42"	● Blanco/Haya	230rpm	190m³/min	50dB	1
300005014	Recambio mando a distancia							



Seram

VENTILADOR



Ventilación Techo

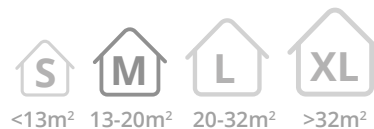

Incluye 2 tijas de 150mm y 250mm

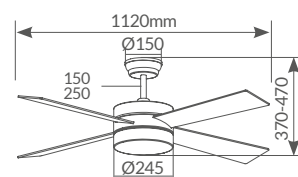

Ventilador de techo con luz Ø112cm

Con 4 aspas ABS transparentes. Con temporizador: 1h., 2h., 8h. Con mando.

3 tonalidades de temperatura (3000K-4000-6500K).

LED reemplazable. Potencia luz: 15W. Lúmenes sin difusor: 1355Lm / 1534Lm / 1475Lm.

Intensidad de la luz regulable. Altura regulable. Apto para techos inclinados hasta 25°. Motor DC. 220-240V. 44".

Referencia	Potencia (máx.)	Veloc.	Color	RPM (máx.)	Flujo (máx.)	Decibelios (máx.)	Embalaje
300005031	28W	6	● Níquel	200rpm	210m³/min	40dB	1
300015000	Recambio placa LED						
300015073	Recambio mando a distancia						

Luma

VENTILADOR

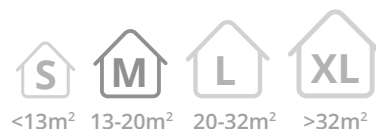

Incluye 2 tijas de 150mm y 250mm

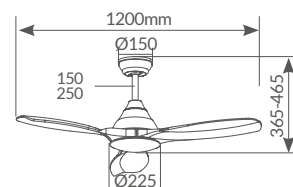

Ventilador de techo con luz Ø117cm

Con 3 aspas ABS. Con temporizador: 1h., 2h., 8h. Con mando.
3 tonalidades de temperatura (3000K-4000-6500K). LED reemplazable.
 Potencia luz: **15W**. Lúmenes sin difusor: **1355Lm / 1534Lm / 1475Lm**. Intensidad de la luz regulable.
 Altura regulable. Apto para techos inclinados hasta 25°. Motor DC. 220-240V. 46". IP20.

Referencia	Artículo	Potencia (máx.)	Veloc.	Color	RPM (máx.)	Flujo (máx.)	Decibelios (máx.)	Emb.
300005029	A	40W	6	○ Blanco	223rpm	210m³/min	40dB	1
300005050	★ B	40W	6	● Negro	223rpm	210m³/min	40dB	1
300015000	Recambio placa LED							
300015073	Recambio mando a distancia							

Bumera

VENTILADOR



A



B

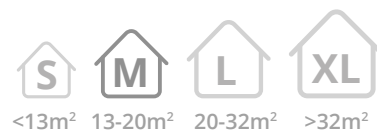

Incluye 2 tijas de 150mm y 250mm

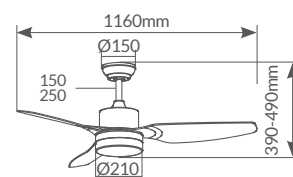

Ventilador de techo con luz Ø116cm

Con 3 aspas ABS. Con temporizador: 1h., 2h., 4h., 8h. Con mando.

3 tonalidades de temperatura (3000K-4000-6500K).

LED reemplazable. Potencia luz: 15W. Lúmenes sin difusor: 1355Lm / 1534Lm / 1475Lm.

Altura regulable. Apto para techos inclinados hasta 25°. Motor AC. 220-240V. 46". IP20.

Referencia	Artículo	Potencia (máx.)	Veloc.	Color	RPM (máx.)	Flujo (máx.)	Decibelios (máx.)	Emb.
300005034	A	63W	3	○ Blanco	200rpm	190m³/min	50dB	1
300005046 ★	B	63W	3	● Negro	200rpm	190m³/min	50dB	1
300015000	Recambio placa LED							
300005014	Recambio mando a distancia							

Biula

VENTILADOR

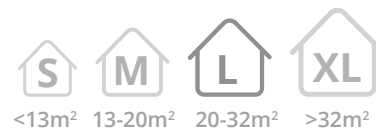
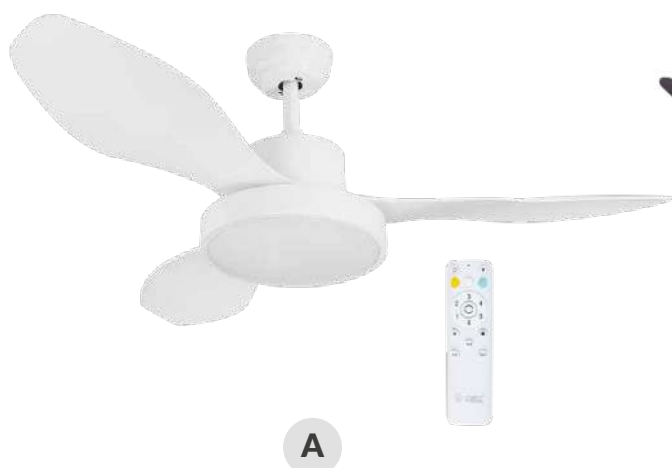

Incluye 2 tijas de 150mm y 250mm

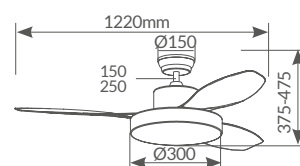

Ventilador de techo con luz Ø122cm

Con 3 aspas ABS. Con temporizador: 1h., 2h., 8h. Con mando.

3 tonalidades de temperatura (3000K-4000-6500K).

LED reemplazable. Potencia luz: 15W. Lúmenes sin difusor: 1355Lm / 1534Lm / 1475Lm.

Intensidad de la luz regulable. Altura regulable. Apto para techos inclinados hasta 25°. Motor DC. 220-240V. 48". IP20.

Referencia	Artículo	Potencia (máx.)	Veloc.	Color	RPM (máx.)	Flujo (máx.)	Decibelios (máx.)	Emb.
300005030	A	40W	6	○ Blanco	223rpm	210m³/min	40dB	1
300005051	★ B	40W	6	● Negro	223rpm	210m³/min	40dB	1
300015000	Recambio placa LED							
300015073	Recambio mando a distancia							

Kota

VENTILADOR

DC



A



B



Modo verano



Modo invierno

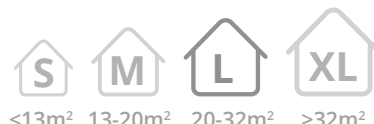

Incluye 2 tijas de 150mm y 250mm

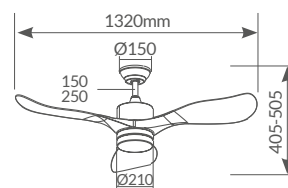

Ventilador de techo con luz Ø132cm

Con 3 aspas ABS. Con temporizador: 1h., 2h., 8h. Con mando.
3 tonalidades de temperatura (3000K-4000-6500K).
LED reemplazable. Potencia luz: **15W**. Lúmenes sin difusor: **1355Lm / 1534Lm / 1475Lm.**
Intensidad de la luz regulable. Altura regulable. Motor **DC. 220-240V. 52".** IP20.

Referencia	Artículo	Potencia (máx.)	Velocidades	RPM (máx.)	Flujo (máx.)	Decibelios (máx.)	Embalaje
300005036	A	28W	6	200rpm	210m³/min	40dB	1
300005037	B	28W	6	200rpm	210m³/min	40dB	1
300015000	Recambio placa LED						
300015073	Recambio mando a distancia						

Mucari

VENTILADOR

DC



A



B



C



D

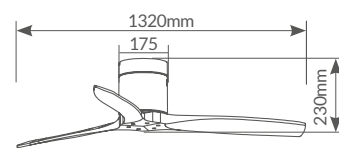
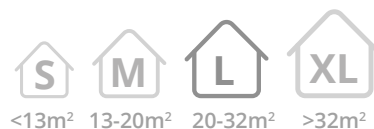

Ventilador de techo Ø132cm

Con **3 aspas de madera**. Con **temporizador**: 15min., 30min., 2h., 4h., 8h.
Con mando. Motor **DC**. 220-240V. **52"**. IP20.

Referencia	Artículo	Potencia (máx.)	Veloc.	Color	RPM (máx.)	Flujo (máx.)	Decibelios (máx.)	Emb.
300005043	A	40W	6	○ Blanco	200rpm	198m³/min	40dB	1
300005044	B	40W	6	● Negro/Haya	200rpm	198m³/min	40dB	1
300005045	C	40W	6	● Blanco/Haya	200rpm	198m³/min	40dB	1
300005054	D	40W	6	● Níquel/Natural	200rpm	198m³/min	40dB	1
300015050	Recambio mando para ventilador ref. 300005043 - 44 - 45							

Ventilación Techo

Matipa

VENTILADOR

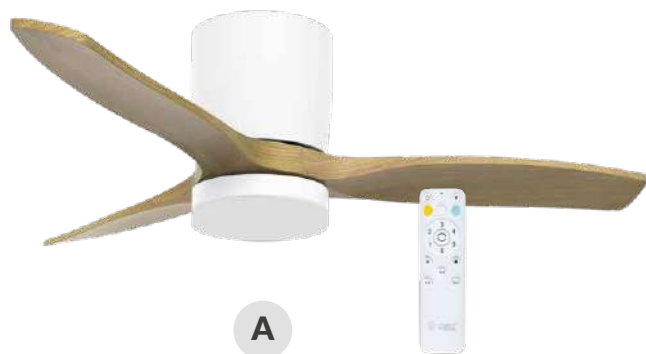

A

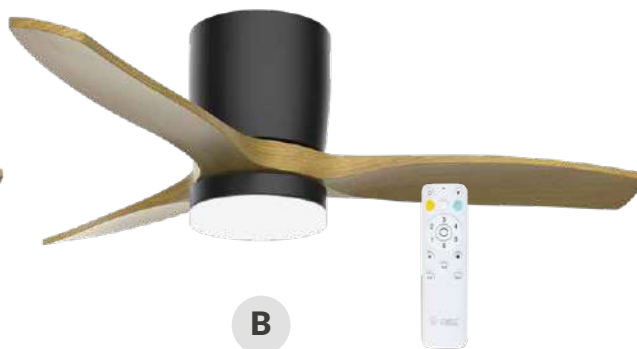

B

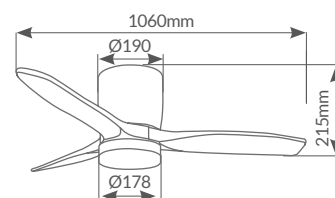

Ventilador de techo con luz Ø106cm

Con 3 aspas ABS. Con temporizador: 1h., 2h., 8h. Con mando.
 3 tonalidades de temperatura (3000K-4000-6500K).
 LED reemplazable. Potencia luz: 15W. Lúmenes sin difusor: 1355Lm / 1534Lm / 1475Lm.
 Intensidad de la luz regulable. Motor DC. 42". 220-240V.

Referencia	Artículo	Potencia (máx.)	Veloc.	Color	RPM (máx.)	Flujo (máx.)	Decibelios (máx.)	Emb.
300005055	A	40W	6	🟡 Blanco/Haya	200rpm	198m³/min	40dB	1
300005056	B	40W	6	⬛ Negro/Haya	200rpm	198m³/min	40dB	1
300015000	Recambio placa LED							
300015073	Recambio mando a distancia							

Solesia

VENTILADOR

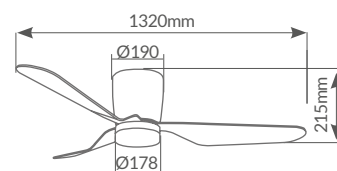
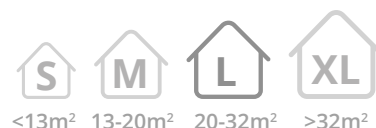

Ventilador de techo con luz Ø132cm

Con **3 aspas ABS**. Con **temporizador**: 1h., 2h., 8h. Con mando. **3 tonalidades de temperatura (3000K-4000-6500K)**. **LED reemplazable**. Potencia luz: **15W**. Lúmenes sin difusor: **1355Lm / 1534Lm / 1475Lm**. **Intensidad de la luz regulable**. Motor **DC**. 220-240V. **52"**. IP20.

Referencia	Artículo	Potencia (máx.)	Veloc.	Color	RPM (máx.)	Flujo (máx.)	Decibelios (máx.)	Emb.
300005057	A	40W	6	○ Blanco	200rpm	198m³/min	40dB	1
300005058	B	40W	6	● Negro	200rpm	198m³/min	40dB	1
300005059	C	40W	6	● Gris	200rpm	198m³/min	40dB	1
300015000	Recambio placa LED							
300015073	Recambio mando a distancia							

Kasama

VENTILADOR

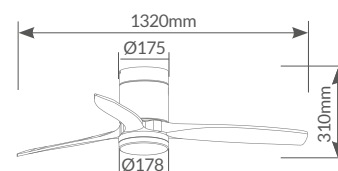
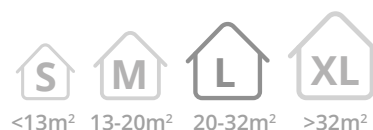
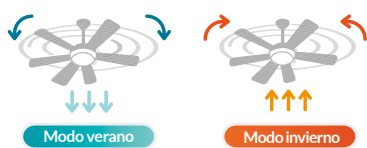
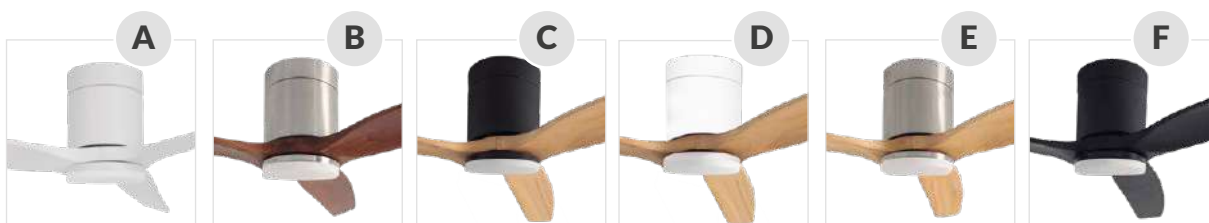

Ventilador de techo con luz Ø132mm

Con 3 aspas de madera. Con temporizador: 1h., 2h., 8h. Con mando.
 3 tonalidades de temperatura (3000K-4000-6500K).
 LED reemplazable. Potencia luz: 15W. Lúmenes sin difusor: 1355Lm / 1534Lm / 1475Lm.
 Intensidad de la luz regulable. Motor DC. 220-240V. 52". IP20.

Referencia	Artículo	Potencia (máx.)	Veloc.	Color	RPM (máx.)	Flujo (máx.)	Decibelios (máx.)	Emb.
300005035	A	40W	6	○ Blanco	223rpm	210m³/min	40dB	1
300005018	B	40W	6	● Níquel/Cerezo	223rpm	210m³/min	40dB	1
300005026	C	40W	6	● Negro/Haya	223rpm	210m³/min	40dB	1
300005027	D	40W	6	● Blanco/Haya	223rpm	210m³/min	40dB	1
300005047 ★	E	40W	6	● Níquel/Haya	223rpm	210m³/min	40dB	1
300005048 ★	F	40W	6	● Negro	223rpm	210m³/min	40dB	1
300015000	Recambio placa LED							
300015073	Recambio mando a distancia							

Saltok
VENTILADOR

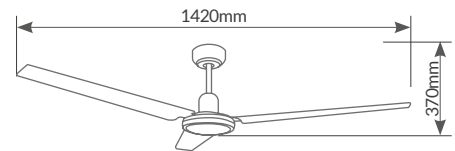
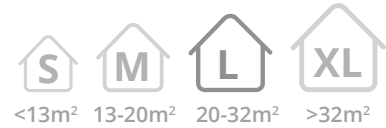

Ventilador techo industrial Ø142cm

Pulgadas: 56". Con 3 aspas metálicas (hierro).
Con controlador de pared. 220-240V. **56".**

Referencia	Potencia (máx.)	Velocidades	RPM (máx.)	Flujo (máx.)	Decibelios (máx.)	Embalaje
300005081	60W	5	280rpm	160m³/min	58dB	1
300015075	Recambio controlador de pared					

Kilwa

VENTILADOR

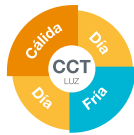

Ideal para grandes estancias



Ventilación Techo

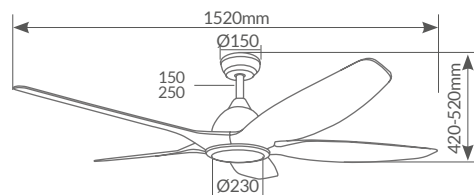
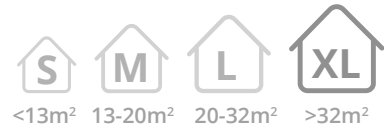

Ventilador de techo con luz Ø152cm

Con 5 aspas ABS. Con temporizador: 1h., 2h., 8h. Con mando.
 3 tonalidades de temperatura (3000K-4000-6500K).
 LED reemplazable. Potencia luz: 18W. Lúmenes sin difusor: 1843Lm / 2087Lm / 1872Lm.
 Intensidad de la luz regulable. Apto para techos inclinados hasta 25°. Motor DC. 220-240V. 60°. IP20.

Referencia	Potencia (máx.)	Veloc.	Color	RPM (máx.)	Flujo (máx.)	Decibelios (máx.)	Emb.
300005060	47W	6	🔆 Blanco/Haya	180rpm	236m³/min	40dB	1
300015073	Recambio mando a distancia						

Diongo

VENTILADOR



Ideal para grandes estancias



Incluye 2 tijas de 150mm y 250mm

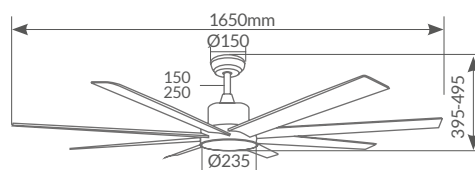

Ventilador de techo Ø165cm

Con 8 aspas ABS. Con temporizador: 15', 30', 2h., 4h., 8h. Con mando. Apto para techos inclinados hasta 25°. Motor DC. 220-240V. 65". IP20.

Referencia	Potencia (máx.)	Veloc.	Color	RPM (máx.)	Flujo (máx.)	Decibelios (máx.)	Emb.
300005061	49W	6	○ Blanco	119rpm	236m³/min	50dB	1
300015050	Recambio mando a distancia						

Bhoor

VENTILADOR



Mayor ángulo de flujo de aire

Rejilla rotatoria



Ventilador de **techo con luz Ø50cm**

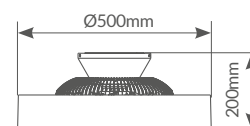

Con **7 aspas**. Con **temporizador**: 2h., 4h., Con mando.
3 tonalidades de temperatura (3000K-4000-6000K).

LED reemplazable. Potencia luz: **36W (3000K y 6000K) 72W (4200K).** Lúmenes sin difusor: **1883Lm / 3865Lm / 2023Lm.**
 Motor **DC. 220-240V. 20".**

Referencia	Potencia (máx.)	Veloc.	Color	RPM (máx.)	Flujo (máx.)	Decibelios (máx.)	Emb.
300005080	15W	6	○ Blanco	1100rpm	172m³/min	45dB	1

Niskot

VENTILADOR

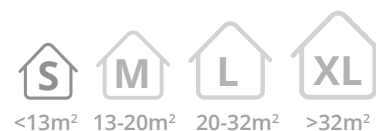

Ventilador de techo Ø57cm

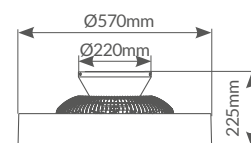

Con **7 aspas transparentes ABS**. Con **temporizador**: 1h., 2h., 4h.
3 tonalidades de temperatura (3000K-4000-6500K). Con mando.
Temperatura de luz regulable. LED reemplazable.
 Potencia luz: **40W**. Lúmenes: **963Lm / 1044Lm / 1062Lm**.
 Motor **AC**. 220-240V. **22"**.

Referencia	Potencia (máx.)	Veloc.	Color	RPM (máx.)	Flujo (máx.)	Decibelios (máx.)	Emb.
300005040	40W	3	● Ocre	1070rpm	32m³/min	58dB	1
300005041	40W	3	● Gris	1070rpm	32m³/min	58dB	1
300005042	40W	3	● Efecto madera	1070rpm	32m³/min	58dB	1
300015047	Recambio mando para ventilador ref. 300005040 - 41 - 42						



Takam

VENTILADOR

AC



Ventilación Techo

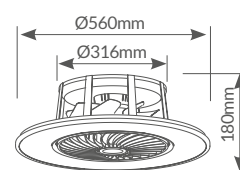

Ventilador de techo box fan con luz Ø56cm

Con **8 aspas interiores ABS**. Con **temporizador**: 1h., 2h.
3 tonalidades de temperatura (3000K-4000-6500K). Con mando.
Temperatura de luz regulable. LED reemplazable.
Potencia luz: **36W**. Lúmenes: **2300Lm / 2450Lm / 2550Lm**.
Color: blanco. Motor AC. 220-240V. **22"**.

Referencia	Potencia (máx.)	Velocidades	RPM (máx.)	Flujo (máx.)	Decibelios (máx.)	Embalaje
300005025	40W	3	1030rpm	110m ³ /min	38dB	1
300015013	Recambio regulador de luz					
300015014	Recambio LEDs					
300015015	Recambio mando a distancia					

Nacala

VENTILADOR



Aspas retráctiles

Instalación con o sin tija

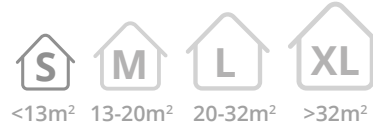

Incluye 2 tijas de 150mm y 250mm

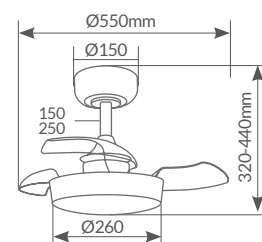

Ventilador de techo con luz Ø55cm

Con 3 aspas desplegadas ABS. Con temporizador: 1h., 2h., 8h. Con mando.

3 tonalidades de temperatura (3000K-4000-6500K).

LED reemplazable. Potencia luz: 24W. Lúmenes sin difusor: 2588Lm / 2948Lm / 2700Lm.

Intensidad de la luz regulable. Apto para techos inclinados hasta 25°. Motor DC. 220-240V. 28". IP20.

Referencia	Potencia (máx.)	Veloc.	Color	RPM (máx.)	Flujo (máx.)	Decibelios (máx.)	Emb.
300005062	47W	6	○ Blanco	192rpm	198m³/min	40dB	1
300015063	Recambio placa LED						
300015073	Recambio mando a distancia						

Lugela

VENTILADOR



Aspas retráctiles

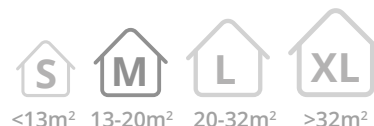

Incluye 2 tijas de 150mm y 250mm

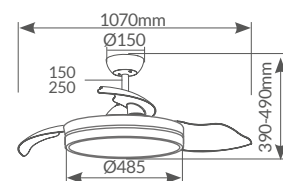

Ventilador de techo con luz Ø107cm

Con 3 aspas desplegables ABS. Con temporizador: 1h., 2h., 4h., 8h. Con mando.
 3 tonalidades de temperatura (3000K-4000-6500K).
 LED reemplazable. Potencia luz: 36W. Lúmenes sin difusor: 3046Lm / 3547Lm / 3238Lm.
 Intensidad de la luz regulable. Apto para techos inclinados hasta 25°. Motor DC. 220-240V. 42". IP20.

Referencia	Potencia (máx.)	Veloc.	Color	RPM (máx.)	Flujo (máx.)	Decibelios (máx.)	Emb.
300005063	19W	6	○ Blanco	210rpm	172m ³ /min	40dB	1
300005064	19W	6	● Negro	210rpm	172m ³ /min	40dB	1
300005065	19W	6	● Níquel	210rpm	172m ³ /min	40dB	1
300015066	Recambio placa LED						
300015074	Recambio mando a distancia						

Tungati

VENTILADOR

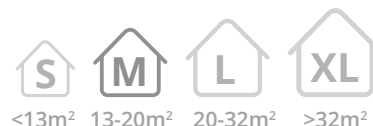

Incluye 2 tijas de 125mm y 250mm

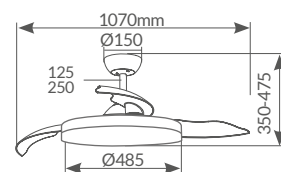

Ventilador de techo con luz Ø107cm

Con 3 aspas desplegadas ABS. Con temporizador: 1h., 2h., 4h., 8h. Con mando.

3 tonalidades de temperatura (3000K-4000-6500K).

LED reemplazable. Potencia luz: 36W. Lúmenes sin difusor: 3046Lm / 3547Lm / 3238Lm.

Intensidad de la luz regulable. Apto para techos inclinados hasta 25°. Motor DC. 220-240V. 42".IP20.

Referencia	Potencia (máx.)	Veloc.	Color	RPM (máx.)	Flujo (máx.)	Decibelios (máx.)	Emb.
300005068	19W	6	○ Blanco	210rpm	172m³/min	40dB	1
300005069	19W	6	● Negro	210rpm	172m³/min	40dB	1
300005070	19W	6	● Níquel	210rpm	172m³/min	40dB	1
300015066	Recambio placa LED						
300015074	Recambio mando a distancia						

Likasi

VENTILADOR

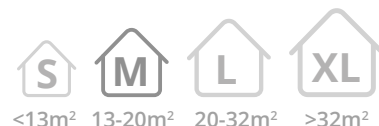
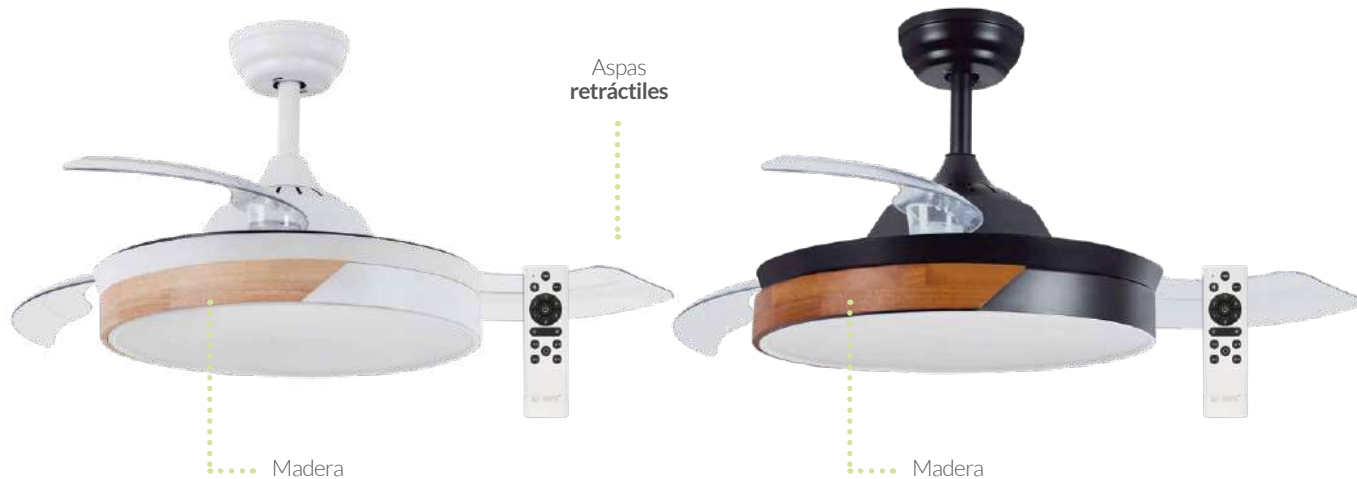

Incluye 2 tijas de 150mm y 250mm

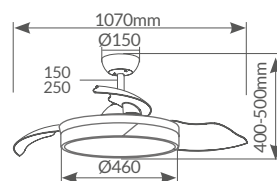

Ventilador de techo con luz Ø107cm

Con 3 aspas desplegables ABS. Con temporizador: 1h., 2h., 4h., 8h. Con mando.

3 tonalidades de temperatura (3000K-4000-6500K).

LED reemplazable. Potencia luz: 36W. Lúmenes sin difusor: 3046Lm / 3547Lm / 3238Lm.

Intensidad de la luz regulable. Apto para techos inclinados hasta 25°. Motor DC. 220-240V. 42". IP20.

Referencia	Potencia (máx.)	Veloc.	Color	RPM (máx.)	Flujo (máx.)	Decibelios (máx.)	Emb.
300005066	19W	6	○ Blanco	210rpm	172m³/min	40dB	1
300005067	19W	6	● Negro	210rpm	172m³/min	40dB	1
300015066	Recambio placa LED						
300015074	Recambio mando a distancia						

Ranta

VENTILADOR

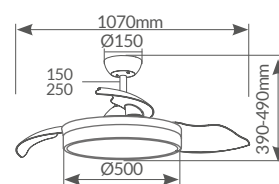
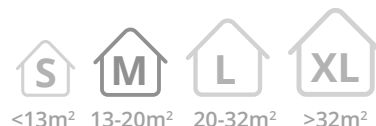

Ventilador de techo con luz Ø107cm

Con 3 aspas desplegadas ABS. Con temporizador: 1h., 2h., 4h., 8h. Con mando.
 3 tonalidades de temperatura (3000K-4000-6500K).
 LED reemplazable. Potencia luz: 36W. Lúmenes sin difusor: 3046Lm / 3547Lm / 3238Lm.
 Intensidad de la luz regulable. Apto para techos inclinados hasta 25°. Motor DC. 42". 220-240V.

Referencia	Potencia (máx.)	Veloc.	Color	RPM (máx.)	Flujo (máx.)	Decibelios (máx.)	Emb.
300005071	19W	6	○ Blanco	210rpm	172m³/min	40dB	1
300005072	19W	6	● Negro	210rpm	172m³/min	40dB	1
300015066	Recambio placa LED						
300015074	Recambio mando a distancia						

Bauala

VENTILADOR

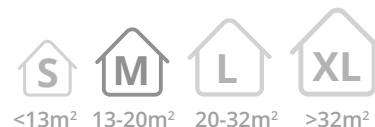

Incluye 2 tijas de 150mm y 250mm

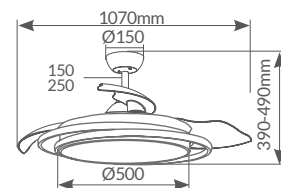

Ventilador de techo con luz Ø107cm

Con 3 aspas desplegables ABS. Con temporizador: 1h., 2h., 4h., 8h. Con mando.
LED reemplazable. Potencia luz: **36W**. Lúmenes sin difusor: **3046Lm / 3547Lm / 3238Lm**.
 Apto para techos inclinados hasta 25°. Motor **DC. 42"**. 220-240V.

Referencia	Potencia (máx.)	Veloc.	Color	RPM (máx.)	Flujo (máx.)	Decibelios (máx.)	Emb.
300005073	19W	6	○ Blanco	210rpm	172m³/min	40dB	1
300005074	19W	6	● Negro	210rpm	172m³/min	40dB	1
300015066	Recambio placa LED						
300015077	Recambio mando a distancia						

Barsat

VENTILADOR



Función temporizador

Función On/Off

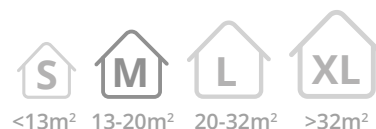
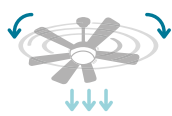

Incluye 2 tijas de 150mm y 250mm

Ventilador de techo inteligente con luz Ø122cm

Con 3 aspas ABS. Con temporizador: 1h., 2h., 4h. Con mando.
 Con luz LED: 3000K. LED reemplazable. Potencia luz: 18W. Lúmenes: 1650Lm.
 Color: blanco. Motor DC. 220-240V. 48". IP20.

Referencia	Potencia (máx.)	Velocidades	RPM (máx.)	Flujo (máx.)	Decibelios (máx.)	Embalaje
300020000	46W	6	200rpm	130 m³/min	40dB	1
300015004	Recambio mando a distancia					



CONTROLA TODOS TUS DISPOSITIVOS DESDE TU SMARTPHONE
 Compatible con smartphones a partir de la versión Android 4.0 & IOS 8.0

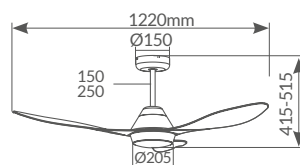

DISFRUTA DE UN HOGAR INTELIGENTE



Ventilación Techo



Calefacción

Climatización



Bardei

MINI CALEFACTOR



Enchufe ajustable
horizontal/vertical

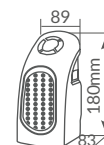

Mini calefactor **sin cable**

2 velocidades: **alta y baja**. Pantalla digital. Botón On/Off. Sin cable y con clavija. Material: **cerámico**. Área de cobertura máx. 15m². **Termostato regulable**. Con **temporizador hasta 12h**. Protección contra sobrecalentamiento. 220-240V.

Referencia	Potencia	Termostato	Color	Embalaje
301000010	Máx. 400W	Sí	● Negro	24
301000013	Máx. 400W	Sí	○ Blanco	24

Mawa

MINI CALEFACTOR

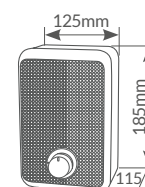

Mini calefactor **vertical**

Termostato regulable. Indicador luminoso de encendido. Cable: 1M. Material: PP.
Dispositivo antivuelco. Se detiene automáticamente si vuelca. Protección contra sobrecalentamiento. 230V.

Referencia	Potencia	Termostato	Embalaje
301000011	Máx. 600W	Sí	20



Kasba

MINI CALEFACTOR

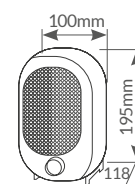

Mini calefactor vertical

Termostato regulable. Indicador luminoso de encendido. Botón On/Off. Cable: 1M. Material: PP.

Dispositivo antivuelco. Se detiene automáticamente si vuelca. Protección contra sobrecalentamiento. 230V.

Referencia	Potencia	Termostato	Embalaje
301000014	Máx. 600W	Sí	20

Tupa

CALEFACTOR

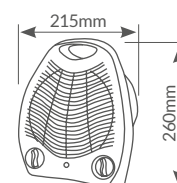

Calefactor vertical

3 posiciones: **natural, templado y caliente.** Indicador luminoso de encendido. Cable: 1.3M.

Termostato regulable. Material: PP. Con asa para transportar. Protección contra sobrecalentamiento. 230V.

Referencia	Potencia	Termostato	Color	Embalaje
005100750	Máx. 2000W	Sí	○ Blanco	6
301000021 ★	Máx. 2000W	Sí	● Negro	6

Tenaf

CALEFACTOR

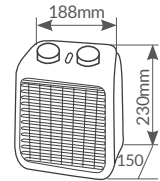

Calefactor vertical

3 posiciones: **natural, templado y caliente**. Indicador luminoso de encendido. Cable: 1.3M. **Termostato regulable**. **Dispositivo antivuelco**. Se detiene automáticamente si vuelca. Protección contra sobrecalentamiento. 220-240V.

Referencia	Potencia	Termostato	Embalaje
301000015	Máx. 2000W	Sí	6

Bikis

CALEFACTOR

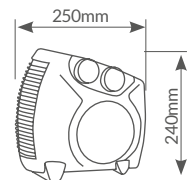

Calefactor vertical/horizontal

3 posiciones: **natural, templado y caliente**. Indicador luminoso de encendido. Cable: 1.5M. **Termostato regulable**. Protección contra sobrecalentamiento. 230V.

Referencia	Potencia	Termostato	Embalaje
005101860	Máx. 2000W	Sí	6



Aitsa

CALEFACTOR

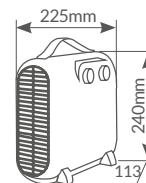

Calefactor vertical/horizontal

3 posiciones: **natural, templado y caliente**. Indicador luminoso de encendido. Cable: 1.2M.
Termostato regulable. Con asa. Protección contra sobrecalentamiento. 220-240V.

Referencia	Potencia	Termostato	Embalaje
301000016	Máx. 2000W	Sí	20

Besah

CALEFACTOR

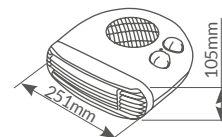

Calefactor horizontal

3 posiciones: **natural, templado y caliente**. Indicador luminoso de encendido. Cable: 1.3M.
Termostato regulable. Protección contra sobrecalentamiento. 230V.

Referencia	Potencia	Termostato	Color	Embalaje
005100751	Máx. 2000W	Sí	○ Blanco	6
301000018 ★	Máx. 2000W	Sí	● Antracita	6

Anakas

CALEFACTOR

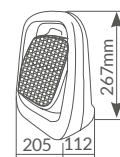

Calefactor vertical cerámico

Con **2 niveles de calefacción**. **Termostato regulable**. Material: **cerámica + ABS**.
Con **asa** para transportar. **Dispositivo antivuelco**. Se detiene automáticamente si vuelca.
Protección contra sobrecalentamiento. Cable: 1.3M. 220-240V.

Referencia	Potencia	Termostato	Embalaje
301000019	Máx. 1500W	Sí	6

Pantu

CALEFACTOR

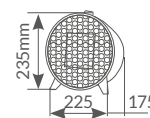

Calefactor vertical cerámico

Con **2 niveles de calefacción**. **Termostato regulable**. Material: **cerámica + ABS**.
Dispositivo antivuelco. Se detiene automáticamente si vuelca.
Protección contra sobrecalentamiento. Cable: 1.3M. 220-240V.

Referencia	Potencia	Termostato	Embalaje
301000020	Máx. 1500W	Sí	6

Saute

CALEFACTOR

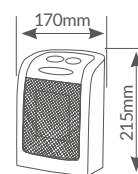

Calefactor vertical cerámico

3 posiciones: **natural, templado y caliente**. Indicador luminoso de encendido. Cable: 1.5M. **Termostato regulable**. **Dispositivo antivuelco**. Se detiene automáticamente si vuelca. Protección contra sobrecalentamiento. 230V.

Referencia	Potencia	Termostato	Embalaje
005100759	Máx. 1500W	Sí	6

Prata

CALEFACTOR

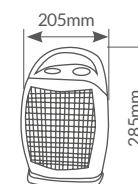

Calefactor vertical giratorio cerámico

3 posiciones: **natural, templado y caliente**. Indicador luminoso de encendido. Cable: 1.4M. **Termostato regulable**. **Dispositivo antivuelco**. Se detiene automáticamente si vuelca. Protección contra sobrecalentamiento. 230V.

Referencia	Potencia	Termostato	Embalaje
005104900	Máx. 1500W	Sí	6

Andaza

CALEFACTOR

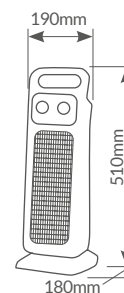
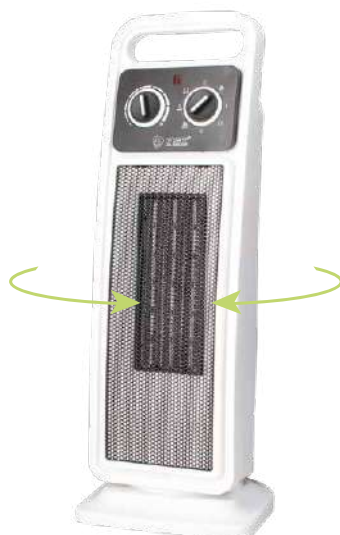

Calefactor vertical giratorio cerámico

2 posiciones: **templado y caliente**. Función ventilador. Indicador luminoso de encendido. **Termostato regulable**. Con asa. **Oscilación automática y modo fijo**. Interruptores independientes. **Dispositivo antivuelco**. Se detiene automáticamente si vuelca. Protección contra sobrecalentamiento. Cable: 1.5M. 220-240V.

Referencia	Potencia	Termostato	Embalaje
301000006	Máx. 2000W	Sí	6

Tanbar

CALEFACTOR

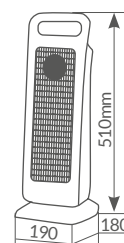

Calefactor vertical giratorio cerámico

Con **2 niveles de calefacción**. Función ventilador. **Termostato regulable de 18 a 45°C**. Con asa. **Oscilación automática y modo fijo**. Material: PP + placa cerámica. **Temporizador** hasta 8h. Panel de control LED **táctil**. **Dispositivo antivuelco**: se detiene automáticamente si vuelca. Protección contra sobrecalentamiento. Cable: 1.3M. 220-240V.

Referencia	Potencia	Termostato	Embalaje
301000017	Máx. 2000W	Sí	1





Nakapa

CALEFACTOR

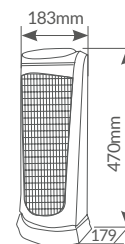

Calefactor vertical giratorio cerámico

2 posiciones: **templado y caliente**. Función ventilador. Indicador luminoso de encendido. **Termostato regulable**. Con asa. Material: **ABS**. Calefactor **cerámico PTC**. **Oscilación automática y modo fijo**. Corte térmico de seguridad. Interruptores independientes. **Dispositivo antivuelco**. Se detiene automáticamente si vuelca. Protección contra sobrecalentamiento. Cable: 1.3M. 220-240V.

Referencia	Potencia	Termostato	Embalaje
301000012	Máx. 2000W	Sí	6

Linisa

CALEFACTOR

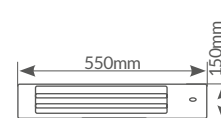

Estufa de cuarzo

Con **2 niveles de calefacción**. 2 tubos con interruptor independiente. Cable: 1.4M. Estructura metálica. **Ideal para baños**. 230V.

Referencia	Potencia	Embalaje
005100754	Máx. 1200W	9



Miary

ESTUFA

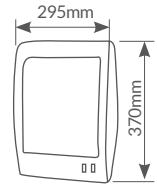

Estufa de cuarzo

Con **2 niveles de calefacción**. 2 tubos con interruptor independiente.
Cable: 1.4M. **Ideal para baños**. 230V.

Referencia	Potencia	Embalaje
005100756	Máx. 800W	8

Fartura

ESTUFA

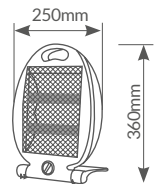

Estufa de cuarzo

Con **2 niveles de calefacción**. 2 tubos de cuarzo. Con asa portátil.
Cable: 1.4M. **Dispositivo antivuelco**. Se detiene automáticamente si vuelca. **Ideal para baños**. 220-240V.

Referencia	Potencia	Embalaje
301010005	Máx. 800W	4
301020009	Recambio tubo de cuarzo para estufa	

Baram

ESTUFA

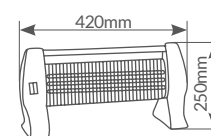

Estufa peana de cuarzo

Con **3 niveles de calefacción**. 3 tubos con interruptor independiente. Cable: 1.4M. **Dispositivo antivuelco**. Se detiene automáticamente si vuelca. 230V.

Referencia	Potencia	Embalaje
005100757	Máx. 1200W	8

Bekitro

ESTUFA

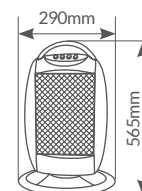

Estufa halógena giratoria

Con **3 niveles de calefacción**. 3 tubos halógenos con interruptor independiente. Con asa. **Oscilante**. Indicador luminoso de encendido. Cable: 1.4M. **Dispositivo antivuelco**. Se detiene automáticamente si vuelca. 230V.

Referencia	Potencia	Embalaje
005100772	Máx. 1200W	4

Lumbis

ESTUFA

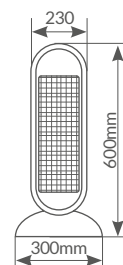

Estufa giratoria tubos carbono

Con **2 niveles de calefacción**. 2 tubos de carbono. **Baja intensidad luminosa**.
Oscilante. Material: **ABS + PP**. Con asa. **Dispositivo antivuelco**.
 Se detiene automáticamente si vuelca. Cable: 1.3M. 220-240V.

Referencia	Potencia	Embalaje
301010013	Máx. 900W	1

Mukah

ESTUFA

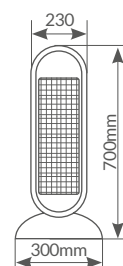

Estufa giratoria tubos carbono

Con **2 niveles de calefacción**. 2 tubos de carbono. **Baja intensidad luminosa**.
Oscilante. Material: **ABS + PP**. Con asa. **Dispositivo antivuelco**.
 Se detiene automáticamente si vuelca. Cable: 1.3M. 220-240V.

Referencia	Potencia	Embalaje
301010012	Máx. 900W	1



Begogo

ESTUFA

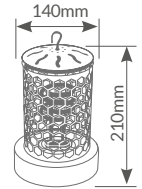

Estufa mesa camilla

Intensidad nominal de 1.74A. Cable: 1.5M. 230V.

Referencia	Potencia	Embalaje
005104904	Máx. 400W	16

Solila

ESTUFA

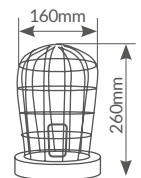

Estufa infrarrojos

Intensidad nominal de 1.09A.
Funciona con **lámparas infrarrojos**. Cable: 1.5M. 230V.

Referencia	Potencia	Casquillo	Embalaje
005100721	Máx. 250W	E27	12

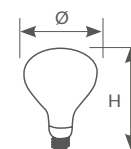

Lámpara infrarrojos

Recomendada para **invernaderos e incubadoras**. Ideal para **preservar la comida caliente en exhibidores**. Perfecto para el **secado industrial** de pintura. Indicada para aliviar **dolores musculares** y de las articulaciones. Horas de vida: 5.000h. 220-240V.

Referencia	Artículo	Potencia	Casquillo	Dimensión	Embalaje
200602002 ★	A	Máx. 150W	E27	Ø125x175mm	24
200602001 ★	A	Máx. 250W	E27	Ø125x175mm	24
002004816	B	Máx. 250W	E27	Ø115x160mm	24

Assis BRASERO

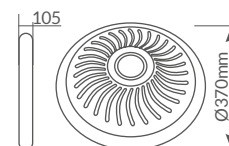

Brasero eléctrico

Con **3 niveles de calefacción**. Con **2 resistencias** blindadas. Cable: 1.7M. Rejilla de seguridad. 230V.

Referencia	Potencia	Embalaje
005100758	Máx. 900W	5

Mococa

ESTUFA GAS

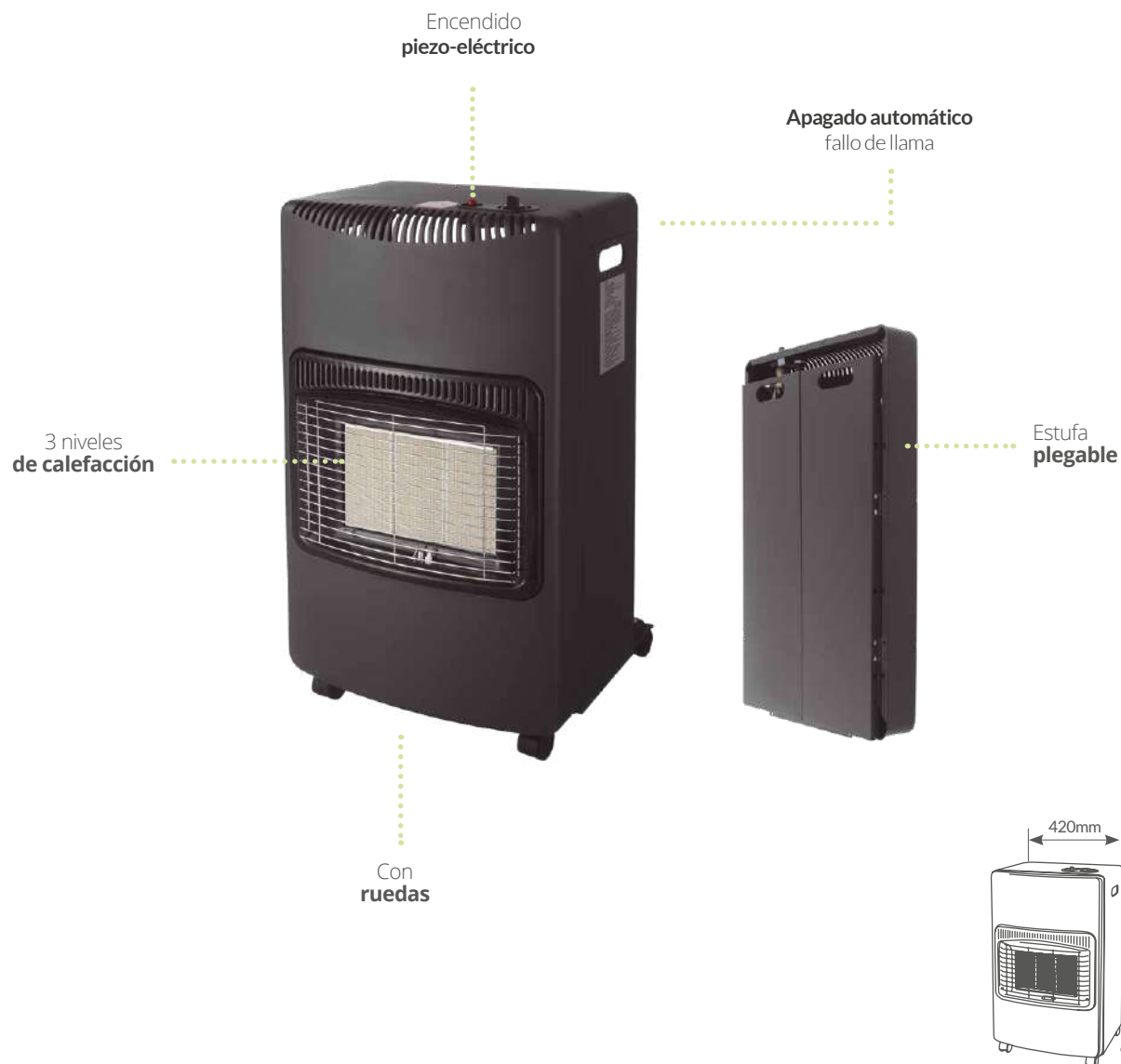

Estufa de gas infrarrojos plegable

3 niveles de calefacción. Encendido **piezo-eléctrico**.

Sistema anti CO₂. Consumo máximo: 305g/h. Con ruedas. Material: **aluminio**.

Apagado automático fallo de llama. **Interruptor antivuelco 42°**. Funciona con una bombona de gas. Peso: **7.9Kg**.

Referencia	Potencia	Área cobertura	Embalaje
301010009	Máx. 4.2KW	20-80m ²	1

Laverton

RADIADOR

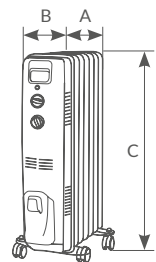

Radiador de aceite

Con **3 niveles de calefacción**. **Termostato regulable**. Con **asa** para transportar y con **ruedas**.

Material: **acero + PP**. Indicador luminoso de encendido. **Dispositivo antivuelco**. Se detiene automáticamente si vuelca. Protección contra sobrecalentamiento. Con recoge cables. Cable: 1.5M. 220-240V.

Referencia	Potencia	Elementos	Dimensión (AxBxC)	Embalaje
301015014	Máx. 1500W	7	250x330x600mm	1
301015015	Máx. 2000W	9	250x404x600mm	1
301015016	Máx. 2500W	11	250x478x600mm	1

Antoby

RADIADOR

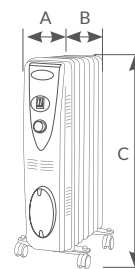

Radiador de aceite

Con **3 niveles de calefacción**. Altura: 650mm. **Termostato regulable**. Con **asa** para transportar y con **ruedas**. Interruptores independientes. Indicador luminoso de encendido. Cable: 1.5M. Protección contra sobrecalentamiento. 220-240V.

Referencia	Potencia	Elementos	Dimensión (AxBxC)	Embalaje
301015000	Máx. 1500W	7	340x240x650mm	1
301015001	Máx. 2000W	9	420x240x650mm	1

Copley

MINI RADIADOR

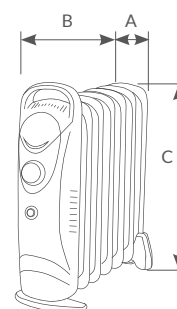

Mini radiador de aceite

Altura: 380mm. **Termostato regulable**. Con **asa** para transportar. Indicador luminoso de encendido. Cable: 1.5M. Protección contra sobrecalentamiento. 220-240V.

Referencia	Potencia	Elementos	Dimensión (AxBxC)	Embalaje
005101864	Máx. 600W	7	140x315x380mm	1
005101865	Máx. 900W	9	140x385x380mm	1

Senbag

RADIADOR

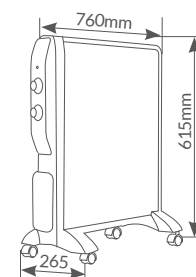

Radiador de mica

Tecnología mica system. Con **2 niveles de calefacción.** **Termostato regulable.** Material: **mica.** Microrrejilla de seguridad. Ruedas pivotantes y recogecables. Cable: 1.45M. **Dispositivo antivuelco.** Se detiene automáticamente si vuelca. Protección contra sobrecalentamiento. Funcionamiento **silencioso.** 220-240V.

Referencia	Potencia	Termostato	Embalaje
301015009	Máx. 2000W	Sí	1

Tarcoola

RADIADOR



Pantalla LED táctil

2 niveles de calefacción

Con mando

No consume oxígeno

Con recogeables

Triple sistema de seguridad

Tecnología mica system



Microrrejilla de seguridad

Máximo rendimiento en 1 min.

Ruedas pivotantes

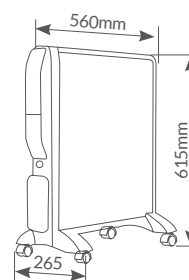

Calefacción Radiadores y emisores térmicos

Radiador de mica

Tecnología mica system. Con 2 niveles de calefacción. Termostato regulable. Material: PP+ABS. Microrrejilla de seguridad. **Pantalla LED táctil.** Ruedas pivotantes y recogeables. Cable: 1.45M. **Dispositivo antivuelco.** Se detiene automáticamente si vuelca. Protección contra sobrecalentamiento. Funcionamiento **silencioso.** 220-240V.

Referencia	Potencia	Termostato	Embalaje
301015018	Máx. 2000W	Sí	1

Beloha

RADIADOR

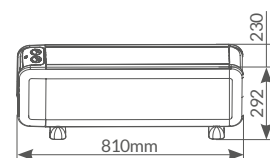
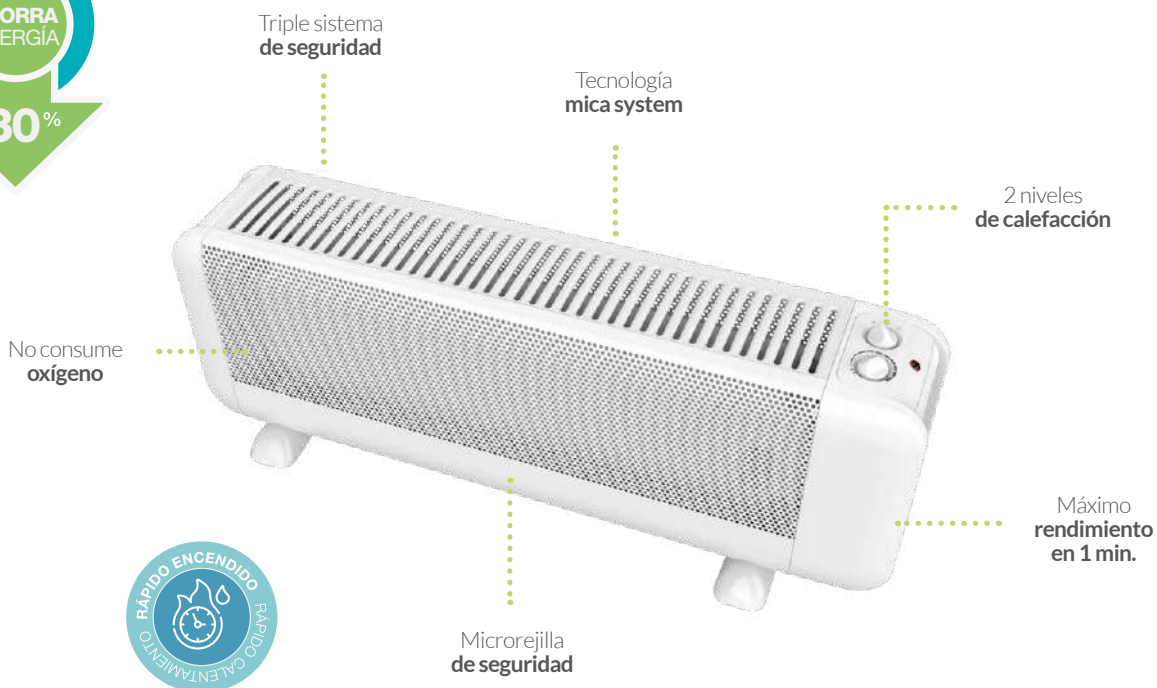

Radiador de mica

Tecnología mica system. Con 2 niveles de calefacción. **Termostato regulable.** Material: **ABS + hierro.** Microrejilla de seguridad. Indicador luminoso de encendido. Con **asa** para transportar. Cable: 1.5M. **Dispositivo antivuelco.** Se detiene automáticamente si vuelca. Protección contra sobrecalentamiento. Funcionamiento **silencioso.** 220-240V.

Referencia	Potencia	Termostato	Embalaje
301015013	Máx. 2000W	Sí	1

Kambal

RADIADOR



Calefacción Radiadores y emisores térmicos

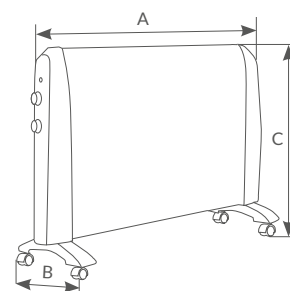

Radiador de mica

Tecnología mica system. Con 2 niveles de calefacción. **Termostato regulable.** Material: mica. Microrejilla de seguridad. Ruedas pivotantes. Cable: 1.45M. **Dispositivo antivuelco.** Se detiene automáticamente si vuelca. Protección contra sobrecalentamiento. Funcionamiento **silencioso.** 220-240V.

Referencia	Potencia	Termostato	Dimensión (AxBxC)	Embalaje
301015010	Máx. 1500W	Sí	690x270x540mm	1
301015017	Máx. 2000W	Sí	790x270x540mm	1

Tukas

EMISOR TÉRMICO

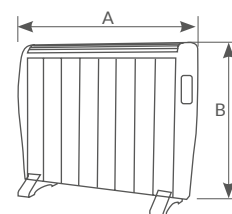

Emisor térmico de bajo consumo

Termostato regulable. Programable diario / semanal. Memoria activa: guarda los ajustes en caso de corte de corriente. Interruptor On/Off. Con **temporizador**. Con **mando a distancia**. Instalación en **suelo y pared**. Incluye patas y set para colgar. Material: **aluminio**. Fácil configuración y programación. Cable: 1.3M. Protección sobrecalentamiento. **Dispositivo antivuelco**. 220-240V.

Referencia	Potencia	Elementos	Área cobertura	Dimensión (AxB)	Embalaje
301015003	Máx. 1200W	8	12-15m ²	690x54x580mm	1
301015004	Máx. 1500W	10	15-18m ²	830x54x580mm	1

Susuk
CALEFACTOR

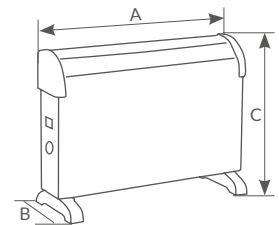

Calefactor **convector**

Con **3 niveles de calefacción**. **Termostato regulable**. Con **asa** para transportar.
Interruptores independientes. Indicador luminoso de encendido. Cable: 1.4M. Protección contra sobrecalentamiento. 220-240V.

Referencia	Modo	Potencia	Dimensión (AxBxC)	Embalaje
301005001 ★	Estándar	Máx. 2000W	535x200x385mm	1
005100762	Estándar	Máx. 2000W	570x190x420mm	1
005100763	Turbo	Máx. 2000W	570x190x420mm	1

Zanthus

RADIADOR

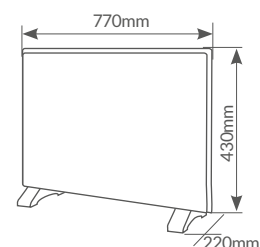

Radiador **convector de cristal**

Con **2 niveles de calefacción**. **Termostato regulable**. Material: **metal + cristal**.
 Área de cobertura: **25m²**. Luz indicadora de encendido. Patas incluidas y **asa** para transportar.
 Cable: 1.4M. Protección contra sobrecalentamiento. **Dispositivo antivuelco**. 220-240V.

Referencia	Potencia	Termostato	Color	Embalaje
301015011	Máx. 2000W	Sí	○ Blanco	1
301015012	Máx. 2000W	Sí	● Negro	1

Smarty

RADIADOR



Funcionamiento
silencioso

Pantalla
LCD

2 niveles
de calefacción

Termostato
regulable

Ruedas
pivotantes



SMARTY WORLD



CONEXIÓN WIFI

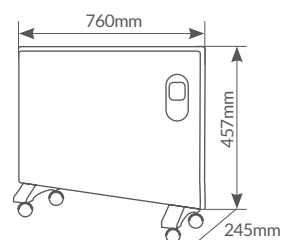

Radiador convector digital inteligente

Con **2 niveles de calefacción**. **Termostato regulable**. Programable diario/semanal. Pantalla **LCD**. Interruptor On/Off. Material: **aluminio**. Área de cobertura: **20-25m²**. Instalación en suelo y pared. Incluye patas y set para colgar. Con ruedas. Cable: 1.45M. Protección para niños y protección contra sobrecalentamiento. 220-240V.

Referencia	Potencia	Termostato	Embalaje
301025000	Máx. 1500W	Sí	1



CONTROLA TODOS TUS DISPOSITIVOS DESDE TU SMARTPHONE
Compatible con smartphones a partir de la versión Android 4.0 & IOS 8.0



DISFRUTA DE UN HOGAR INTELIGENTE

Nanga

CALEFACTOR



Con mando
a distancia

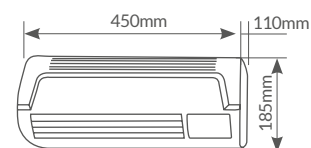

Calefactor split de pared

2 posiciones: **templado y caliente. Termostato regulable.**

Con **temporizador de 7.5h.** Programable **diario/semanal.** Con mando a distancia.

Pantalla indicadora LED. Rápido calentamiento y temperatura estable. Instalación en **pared.**

Incluye set para colgar. Material: **ABS.** Cable: 1.5M. Protección contra sobrecalentamiento. IP20. 220-240V.

Referencia	Potencia	Área cobertura	Embalaje
301000004	Máx. 2000W	15-25m ²	1

Tabah

CALEFACTOR



Con mando
a distancia



Función
oscilante

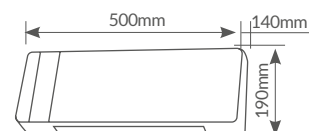

Calefactor split de pared

2 posiciones: **templado y caliente. Termostato regulable. Función oscilante.**

Con **temporizador de 7.5h.** Programable **diario/semanal.** Con mando a distancia.

Pantalla indicadora LED. Rápido calentamiento y temperatura estable. Instalación en **pared.**

Incluye set para colgar. Material: **ABS.** Cable: 1.5M. Protección contra sobrecalentamiento. IP22. 220-240V.

Referencia	Potencia	Área cobertura	Embalaje
301000005	Máx. 2000W	15-25m ²	1



Tilpa

ESTUFA



Calefacción Exterior

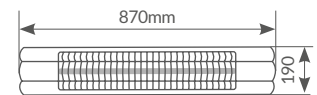
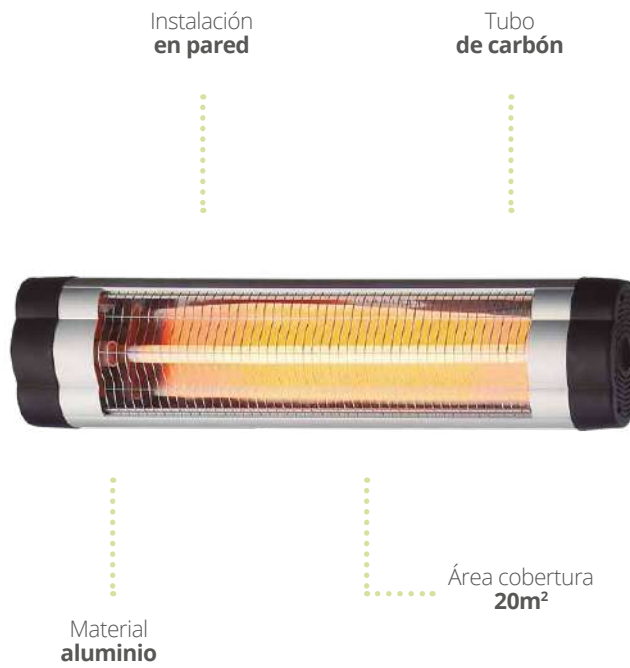

Estufa para exterior de tubo de carbón

Con luz indicadora. Material: **aluminio**. Rejilla de seguridad. Con un **tubo de carbón**.
Instalación en **pared**. Cable: 1.35M. **IP34**. 220-240V.

Referencia	Potencia	Área cobertura	Embalaje
301010003	Máx. 2000W	20m ²	1

Behara

ESTUFA



3 tubos de cuarzo

Instalación en suelo y pared

Área cobertura 20-25m²

3 niveles de calefacción

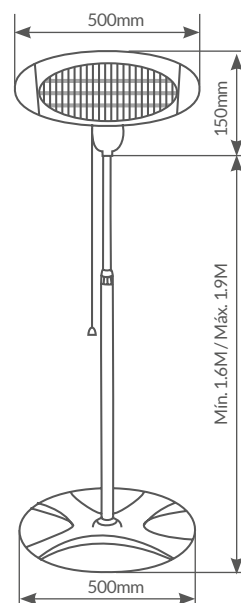

Estufa con soporte para exterior de cuarzo

Con **3 niveles de calefacción**. Con interruptor por cuerda. Material: **acero + PC**.
Rejilla de seguridad. Con **3 tubos de cuarzo**. Instalación en **suelo y pared**. Cable: 1.9M. **IPX4**. 220-240V.

Referencia	Potencia	Área cobertura	Embalaje
301010008	Máx. 2000W	20-25m ²	1
301020001	Recambio tubo carbón para estufa ref. 301010008		



Rasau

ESTUFA

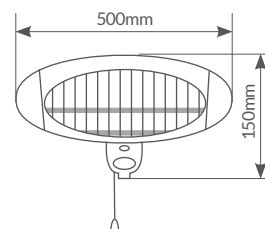

Estufa para exterior de cuarzo

Con **3 niveles de calefacción**. Con interruptor por cuerda. Material: **acero**. Rejilla de seguridad. Con **3 tubos de cuarzo**. Instalación en **pared**. Cable: 1.9M. **IPX4**. 220-240V.

Referencia	Potencia	Área cobertura	Embalaje
301010004	Máx. 2200W	20-25m ²	1
301020001	Recambio tubo carbón para estufa ref. 301010004		

Mandor

ESTUFA

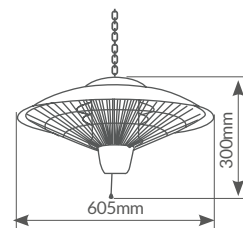

Estufa para exterior halógena

Con **2 niveles de calefacción**. Con interruptor por cuerda. Material: **aluminio + PC**. Cadena incluida. Rejilla de seguridad. Con **2 tubos halógenos**. Instalación en **techo**. Cable: 1.6M. **IP34**. 220-240V.

Referencia	Potencia	Área cobertura	Embalaje
301010007	Máx. 2000W	20m ²	1

Saliki

CALEFACTOR

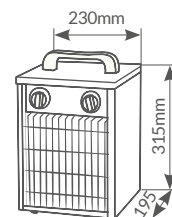

Calefactor industrial

Con **3 niveles de calefacción**. **Termostato regulable**. Con **asa de goma** para transportar y rejilla de seguridad. Pintura para soportar altas temperaturas. Interruptor On/Off. Material: **acero**. Cable: 1.35M. Protección sobrecalentamiento. IP24. 220-240V.

Referencia	Potencia	Área cobertura	Embalaje
301000007	Máx. 2000W	20m ²	1

Tenom

CALEFACTOR

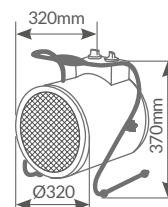

Calefactor industrial

3 niveles de calefacción. **Termostato regulable**. Interruptor On/Off. Material: **acero inoxidable**. Cable: 1.2M. Protección sobrecalentamiento. IP24. 220-240V.

Referencia	Potencia	Área cobertura	Embalaje
301000001	Máx. 3000W	25-30m ²	1



Cocina

PAE



Esira

EXPRIMIDOR

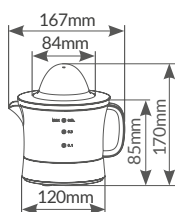

Exprimidor eléctrico

Función automática de **giro derecha/izquierda**.

Función automática arranque/parada. Base antideslizantes. Con enrolla cables. Tapa protectora. Cable: 0.85M. Fácil de desmontar y limpiar. Piezas desmontables aptas para lavavajillas. 220-240V.

Referencia	Potencia	Capacidad	Embalaje
400025004	25W	0.5L	18

Bekily

EXPRIMIDOR

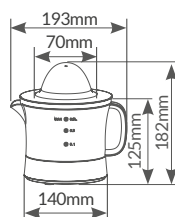

Exprimidor eléctrico

Función automática de **giro derecha/izquierda**.

Función automática arranque/parada. Base antideslizantes. Con enrolla cables. Tapa protectora. Cable: 0.85M. Fácil de desmontar y limpiar. Piezas desmontables aptas para lavavajillas. 220-240V.

Referencia	Potencia	Capacidad	Embalaje
400025005	40W	1L	12

Misten

EXPRIMIDOR

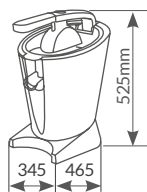

*Sugerencia de presentación.

Exprimidor con brazo

Brazo de presión. **Caño antigoteo**. Control de velocidad. Velocidad: 180rpm. Material: **ABS + PP**. Incluye **2 conos** para exprimir. Base antideslizante. Cable: 0.9M. Fácil de desmontar y limpiar. Piezas desmontables aptas para lavavajillas. 220-240V.

Referencia	Potencia	Embalaje
400025003	160W	4

Kalimera

BATIDORA

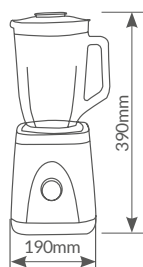

Profundidad: 180mm



*Sugerencia de presentación.

Batidora vaso 1000W

Velocidades: Alta / Baja / Impulsos cortos y potentes. Cuchilla de acero inoxidable de gran solidez, desmontable para un fácil limpiado. Material: **PP**. Longitud cable: 0.9M. **Ideal para picar hielos**. Piloto LED luminoso. Fácil de desmontar y limpiar. 220-240V.

Referencia	Potencia	Capacidad	Embalaje
400005006	1000W	1.5L.	3
400090000	Recambio jarra		
400090001	Recambio cuchillas		
400090002	Recambio tapa		

Kever

BATIDORA



*Sugerencia de presentación.

Batidora brazo 700W

Dos niveles de velocidad. Con **botón turbo.** Cuchillas de acero inoxidable, especial triturar. Mango ergonómico. Brazo desmontable de ABS. Longitud cable 0.75M. Fácil de desmontar y limpiar. 220-240V.

Referencia	Potencia	Velocidades	Embalaje
400005007	700W	2	12/167

Turbox

BATIDORA

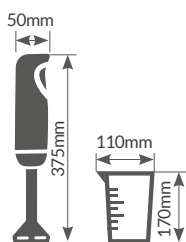

*Sugerencia de presentación.

Batidora brazo Turbox

Seis niveles de velocidad. Con **botón turbo.** Cuchillas de acero inoxidable, especial triturar. Mango ergonómico. Brazo desmontable de acero inoxidable. Vaso: 700ml. Fácil de desmontar y limpiar. 220-240V.

Referencia	Potencia	Velocidades	Embalaje
002701389	700W	6	15
400005002	Recambio vaso medidor		

Singat

BATIDORA

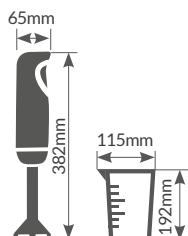

Batidora brazo Singat

Seis niveles de velocidad. Con **botón turbo**. Cuchillas de acero inoxidable. Luz indicadora LED. Mango ergonómico. Brazo desmontable de acero inoxidable. Vaso: 800ml. Fácil de desmontar y limpiar. 220-240V.

Referencia	Potencia	Velocidades	Embalaje
400005009	700W	2	12
400090040	Recambio eje		
400090041	Recambio vaso medidor		

Aliara

BATIDORA

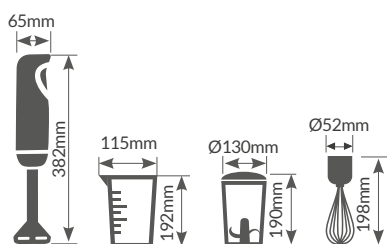

Batidora de brazo Aliara

Bate, pica y tritura. Brazo: desmontable de **acero inoxidable**. Con **botón turbo**. Vaso y picadora: 800ml. Cuchillas de acero inoxidable. Mango ergonómico. Fácil de desmontar y limpiar. 220-240V.

Referencia	Potencia	Velocidad	Embalaje
400005010	1200W	Regulable	4
400090041	Recambio vaso medidor		
400090042	Recambio picadora		
400090039	Recambio eje		
400090043	Recambio varilla		

*Sugerencia de presentación.

Dobos

BATIDORA

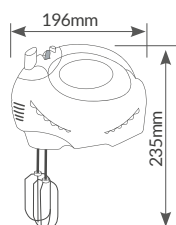

Profundidad: 90mm



*Sugerencia de presentación.

Batidora amasadora 200W

Botón **turbo**. Con varillas para batir y varillas para amasar.
Fácil extracción de las varillas a través de un botón. Longitud del cable: 1M. 220-240V.

Referencia	Potencia	Velocidades	Embalaje
400005008	200W	5	4

Kaffy

MOLINILLO

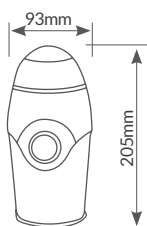

*Sugerencia de presentación.

Molinillo de café 200W

Cuchillas y bol de **acero inoxidable**. Motor de cobre. Con **cierre de seguridad**.
Con enrolla cables. Fácil limpieza. **Libre de BPA**. Longitud del cable: 1.1M. 220-240V.

Referencia	Potencia	Capacidad	Embalaje
400010024	200W	50gr.	24

Mocca

CAFETERA

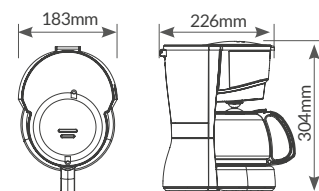

Cafetera eléctrica 10 tazas

Sistema antigoteo. Depósito de agua translúcido y graduado. Botón de encendido y apagado con piloto indicador de funcionamiento. **Dispositivo sobrecalentamiento.** Jarra de cristal con tapa. 220-240V.

Referencia	Potencia	Capacidad	Embalaje
400010019	800W	1.25L	6
400010020	Filtro para cafetera		
400010021	Jarra para cafetera		



Sembe

CAFETERA



4/6/9
Tazas

*Sugerencia de presentación.

Cocina Cafeteras

Cafetera de inducción

Apta para todo tipo de fuegos. Asa sólida ergonómica. Tapa abatible. Cuerpo de **acero inoxidable**.

Referencia	Capacidad	Embalaje
002703007	4 tazas	24
002703008	6 tazas	24
002703009	9 tazas	24
400090022	Recambio anillo silicona para cafetera Sembe ref. 002703007	
400090023	Recambio anillo silicona para cafetera Sembe ref. 002703008	
400090024	Recambio anillo silicona para cafetera Sembe ref. 002703009	
400090025	Recambio filtro y embudo para 002703007	
400090027	Recambio filtro y embudo para 002703008	
400090028	Recambio filtro y embudo para 002703009	



Lington

CAFETERA



*Sugerencia de presentación.



3/6/9/12
Tazas

Cafetera tradicional **inducción**

Apta para todo tipo de fuegos. Asa sólida ergonómica. Tapa abatible. Cuerpo de **aluminio**.

Referencia	Capacidad	Embalaje
400010002	3 tazas	36
400010003	6 tazas	24
400010004	9 tazas	12
400010005	12 tazas	12
400010015	Recambio filtro y embudo para 400010002	
400010016	Recambio filtro y embudo para 400010003	
400010017	Recambio filtro y embudo para 400010004	
400010018	Recambio filtro y embudo para 400010005	

Luwak

CAFETERA



3/6/9
Tazas

*Sugerencia de presentación.

Cocina Cafeteras

Cafetera inducción

Apta para todo tipo de fuegos. Asa sólida ergonómica. Tapa abatible. Cuerpo de aluminio.

Referencia	Capacidad	Color	Embalaje
400010009	3 tazas	● Rojo	36
400010010	6 tazas	● Rojo	24
400010011	9 tazas	● Rojo	12
400010015	Recambio filtro y embudo para 400010009		
400010016	Recambio filtro y embudo para 400010010		
400010017	Recambio filtro y embudo para 400010011		

Bobble

HERVIDOR

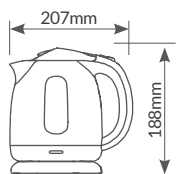

Hervidor de agua

Interruptor de encendido e indicador luminoso. Tapa con **cierre de seguridad**. Filtro lavable extraíble.

Apagado automático. Protección contra ebullición en seco. Indicador nivel de agua.

Sistema de calentamiento: con plato. **Base rotatoria:** 360°. Longitud del cable: 0.75M. 220-240V. 50/60Hz.

Referencia	Potencia	Capacidad	Embalaje
400010022	1100W	1L	12

Kupla

HERVIDOR

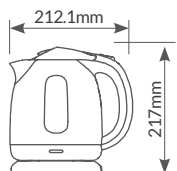

Hervidor de agua

Interruptor de encendido e indicador luminoso. Tapa con **cierre de seguridad**. Filtro lavable extraíble.

Apagado automático. Protección contra ebullición en seco. Indicador nivel de agua.

Sistema de calentamiento: con plato. **Base rotatoria:** 360°. Longitud del cable: 0.75M. 220-240V. 50/60Hz.

Referencia	Potencia	Capacidad	Embalaje
400010023	2200W	1.7L	12

Muala

HERVIDOR

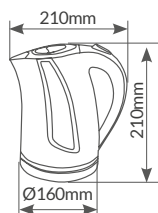

Hervidor de agua

Interruptor de encendido e indicador luminoso. Tapa **abatible** con **cierre de seguridad**. Filtro lavable extraíble.

Apagado automático. Protección contra ebullición en seco. Indicador nivel de agua.

Sistema de calentamiento: con plato. **Base rotatoria:** 360°. Longitud del cable: 0.70M. 200-240V. 50/60Hz.

Referencia	Potencia	Capacidad	Embalaje
400010028	2000W	1.8L	12



Broa

TOSTADORA

Grado de tostado
regulable



*Sugerencia de presentación.



Bandeja
recogemigas

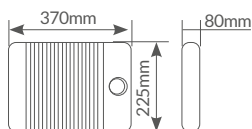

Tostadora plana

Grado de **tostado regulable**. Gran superficie de tostado. Ranura de acero con bandeja **recogemigas extraíble**. **Temporizador** con apagado automático. Tubo de cuarzo. Material: **acero inoxidable**. 220-240V.

Referencia	Potencia	Superficie útil	Embalaje
400075000	600W	270x220mm	6



Millo

TOSTADORA

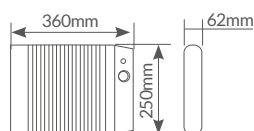

Tostadora plana

Grado de **tostado regulable**. Gran superficie de tostado. Ranura de acero con bandeja **recogemigas extraíble**. **Temporizador** con apagado automático. Tubo de cuarzo. Material: **acero inoxidable**. 220-240V.

Referencia	Potencia	Superficie útil	Embalaje
400075001	600W	245x195mm	6

Multispace

TOSTADORA

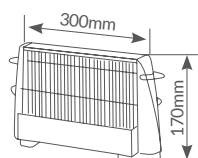

Profundidad: 90mm

*Sugerencia de presentación.

Tostadora **vertical**

Grado de **tostado manual**. Gran superficie de tostado. Interruptor ON/OFF. **Empuñaduras frías**.
Capacidad: **hasta 4 rebanadas**. Todo tipo de pan. Material: **acero inoxidable**. 220-240V.

Referencia	Potencia	Superficie útil	Embalaje
002703030	700W	250x190mm	12

Avocado

TOSTADORA

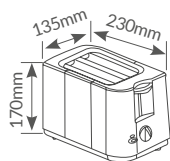

*Sugerencia de presentación.

Cocina Tostadoras

Tostadora vertical

Grado de **tostado regulable**. Con **temporizador**. **Botón STOP**. Capacidad: hasta 2 rebanadas. Bandeja recogemigas. Longitud cable: 0.85M. Patas antideslizantes. Todo tipo de pan. Con 2 ranuras de **acero inoxidable**. 220-240V.

Referencia	Potencia	Funciones	Embalaje
400075002	700W	Descongelar / Calentar	6

Fletcher

TOSTADORA

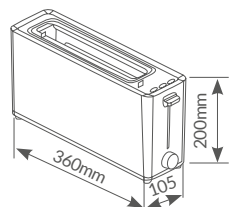

*Sugerencia de presentación.

Tostadora

Grado de **tostado regulable**. Bandeja **recogemigas**. Indicadores luminosos.
Capacidad: hasta 2 rebanadas. Amplia ranura para colocar diferentes tipos de pan. Con recogecables. 220-240V.

Referencia	Potencia	Funciones	Embalaje
002701746	900W	Descongelar / Calentar	6

Blasus

SANDWICHERA



Prepara **tus sándwiches preferidos** de 2 en 2

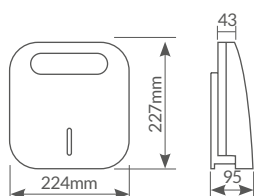

*Sugerencia de presentación.

Sandwichera **doble**

Revestimiento **antiadherente**. Regulador automático de temperatura. Tapa de **toque frío**.
Piloto de control de encendido y temperatura. Base antideslizante. Longitud cable: 0.8M. 220-240V.

Referencia

Potencia

Embalaje

400065000

750W

6

Amantta

SANDWICHERA

Ideal para **tus asados**



Regulador de temperatura

Prepara **tus sándwiches preferidos** sin importar la altura



Tapa basculante



*Sugerencia de presentación.

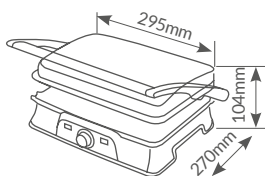

Sandwichera grill

Amplia superficie, **doble grill**. Revestimiento **antiadherente**. Asa toque frío. **Tapa basculante**: se adapta al grosor del alimento. **Regulador de temperatura**. 2 vasos recoge grasas. Protección sobrecalentamiento. Material: **tapa acero inoxidable**. LED indicador de encendido y temperatura. 220-240V.

Referencia	Potencia	Apertura	Superficie útil	Embalaje
002703031	1500W	180°	275x170mm (x2 placas)	4

Pipu

SANDWICHERA



Placas
intercambiables

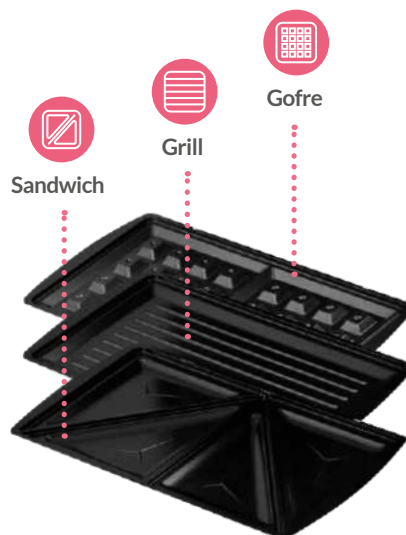
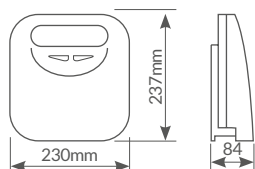

*Sugerencia de presentación.

Sandwichera 3 en 1 con 3 placas

Con **3 placas intercambiables**. Revestimiento **antiadherente**.

Protección sobrecalentamiento. LED indicador de encendido y temperatura. Longitud cable: 0.8M. 220-240V.

Referencia	Potencia	Placas	Embalaje
400065001	750W	Sándwich / Grill / Gofre	6



Tempur

FREIDORA

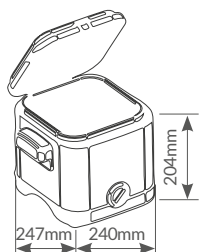

*Sugerencia de presentación.

Freidora 1.5L.

Material: cuerpo **acero inoxidable**. Depósito **antiadherente**.

Contenedor de aceite fijo. Fácil sujeción con **asa lateral**.

Termostato regulable con indicador luminoso. 230V. 50Hz.

Referencia	Potencia	Capacidad	Embalaje
400035000	900W	1.5L.	4

Kamut

FREIDORA

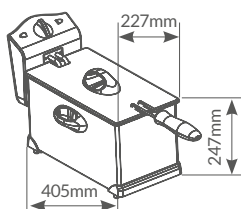

Freidora 3L.

Material: **acero inoxidable**. Tubo de cuarzo.

Cubierta desmontable. Contenedor de aceite y **asa desmontable**.

Asa de **toque frío**. Fácil sujeción con **asa lateral**.

Termostato regulable con indicador luminoso. 230V. 50Hz.

Referencia	Potencia	Capacidad	Embalaje
400035001	2000W	3L.	4

Sabiri

FREIDORA



**Recetario
incluido**

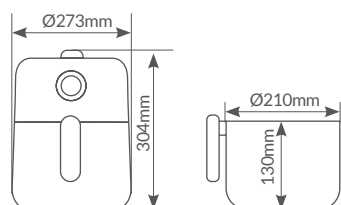

Freidora sin aceite 3.2L.

Regulador de temperatura 80-200°. Temporizador hasta 60 minutos.

Tecnología de **circulación de aire de alta velocidad**. Indicador sonoro de apagado automático.

Cubeta extraíble. Con bandeja para freír. Indicadores luminosos. Protección sobrecalentamiento.

Recetario incluido. Asa frontal. Longitud del cable: 0.88M. 220-240V.

Referencia	Potencia	Capacidad	Color	Embalaje
400035014	1450W	3.2L.	● Negro	2
400035015	1450W	3.2L.	○ Blanco	2

Naria

FREIDORA

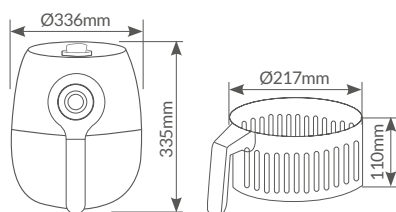

Las cestas de silicona se venden por separado.

*Sugerencia de presentación.

recetario incluido.

Freidora sin aceite 5L.

Regulador de temperatura 80-200°. Temporizador de hasta **1 a 30 minutos.**

Tecnología de **circulación de aire de alta velocidad.** Indicador sonoro de apagado automático.

Bandeja y cesta extraíbles. Indicadores luminosos. Protección sobrecalentamiento.

Recetario incluido. Asa frontal. Longitud del cable: 0.88M. 220-240V.

Referencia	Potencia	Capacidad	Embalaje
400035012	1450W	5L.	2
400091001	Cesta de silicona Ø211m para freidora de aire		
400091002	Cesta de silicona 204x204mm para freidora de aire		

Assane

FREIDORA



*Sugerencia de presentación.

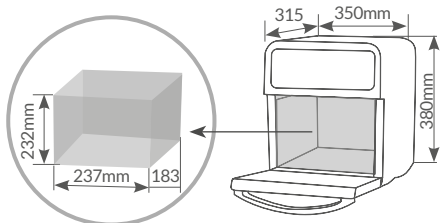

Las cestas de silicona se venden por separado.



Freidora sin aceite tipo horno 10L.

Regulador de temperatura 80-200°. Temporizador hasta 60 minutos.
 Pantalla **LED táctil**. Indicador sonoro de fin de cocinado. **Función memoria.**
Incluye 5 accesorios: rejilla, cesta, soporte asado, pinza y bandeja de aceite.
 Material: PP + Acero inoxidable. Indicadores luminosos. Protección sobrecalentamiento.
Recetario incluido. Asa frontal. Longitud del cable: 0.75M. 220-240V.

Referencia	Potencia	Capacidad	Embalaje
400035013	1700W	10L.	1
400091001	Cesta de silicona Ø211m para freidora de aire		
400091002	Cesta de silicona 204x204mm para freidora de aire		



Essenza

HORNO ELÉCTRICO



*Sugerencia de presentación.

Con doble cristal

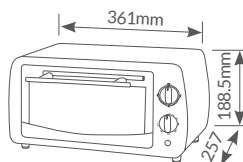

Horno eléctrico 9L.

3 funciones: **coCCIÓN superior**, **coCCIÓN inferior** y **coCCIÓN superior/inferior**.

Temporizador con aviso de 30min. **Doble cristal**. Señal fin de cocinado.

Fácil de usar y limpiar. Con **bandeja de cocción** y **rejilla**. 220-240V.

Referencia	Potencia	Capacidad	Embalaje
002703041	800W	9L.	2

Kuhati

HORNO ELÉCTRICO



Horno eléctrico 23L.

3 funciones: **cocción superior, cocción inferior y cocción superior/inferior.**
Temporizador con aviso de 60min. **Doble cristal.** Señal fin de cocinado.
 Fácil de usar y limpiar. Con **bandeja de cocción y rejilla.** 220-240V.

Referencia	Potencia	Capacidad	Embalaje
400040000	1500W	23L.	2

*Sugerencia de presentación.

Valvika

MICROONDAS



Temporizador
hasta 30min.

5 niveles de
potencia

Función
descongelar

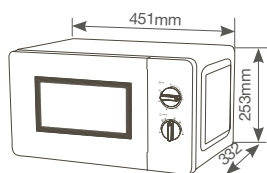

*Sugerencia de presentación.

Microondas 20L.

5 niveles de potencia seleccionables. **Función descongelar.**

Temporizador de 30 minutos con apagado automático. Luz interior automática.

Señal fin de cocinado. Fácil de usar y limpiar. Con plato giratorio. Material: **metal + PC**. Longitud del cable: 0.85M. 230V.

Referencia	Potencia	Capacidad	Embalaje
400045001	700W	20L.	1

Helnes

MICROONDAS

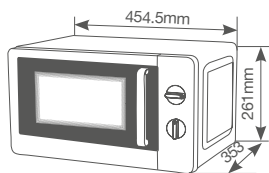
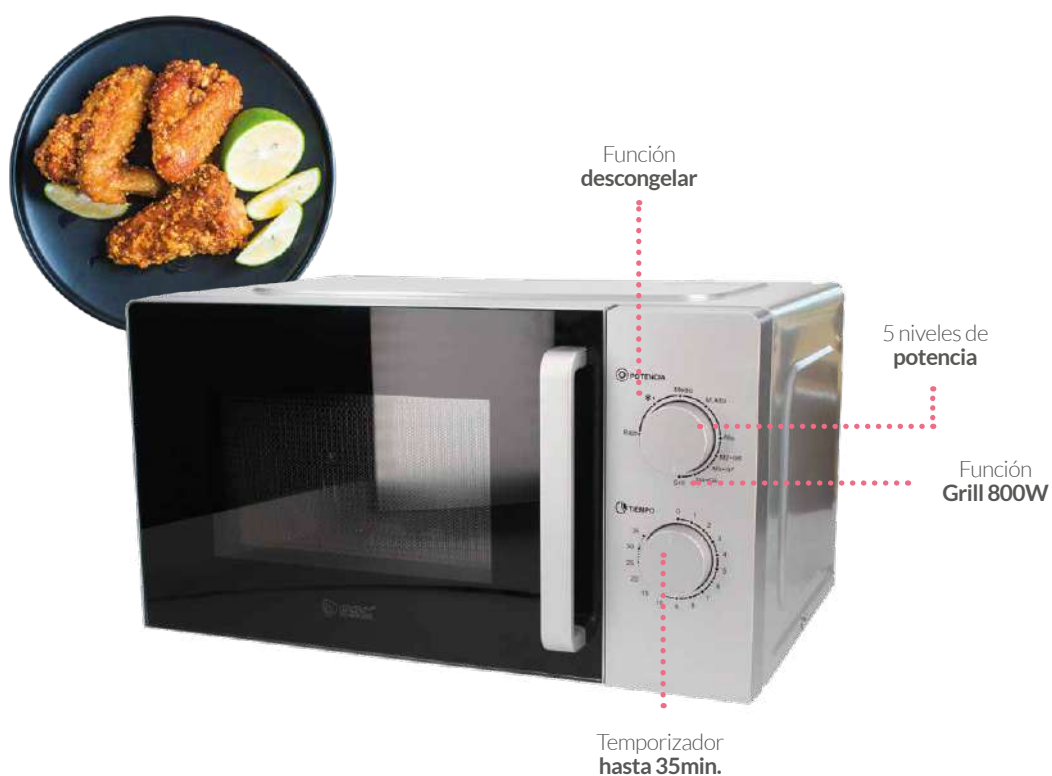

*Sugerencia de presentación.

Microondas con grill **20L.**

5 niveles de potencia seleccionables. **Función descongelar.**

Temporizador de 35 minutos con apagado automático. **Con grill 800W.** Luz interior automática. Con asa para abrir. Señal fin de cocinado. Fácil de usar y limpiar. Con plato giratorio. Material: **metal + PC.** Longitud del cable: 0,85M. 230V.

Referencia	Potencia	Capacidad	Embalaje
400045003	700W	20L.	1

Sorsele

MICROONDAS



*Sugerencia de presentación.

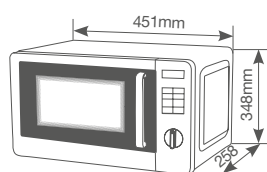

Microondas con grill 20L.

5 niveles de potencia seleccionables. Función descongelar regulable en tiempo y peso. Pantalla LED. Temporizador de 60 minutos con apagado automático. Con bloqueo para niños/as. Luz interior automática. Con asa para abrir. Función diferida, función cocinar, función reloj. Con grill / Combi 800W. Botón de inicio y de pausa. Señal fin de cocinado. Fácil de usar y limpiar. Con plato giratorio. Material: metal + acero inox. + PC. Longitud del cable: 0.85M. 230V.

Referencia	Potencia	Capacidad	Embalaje
400045004	700W	20L.	1

Unix

PLACA ELÉCTRICA

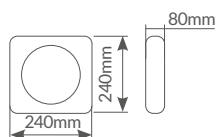

*Sugerencia de presentación.

Placa eléctrica

De **1 quemador**. Tipo: **portátil**. Luz de encendido y apagado. Con **termostato**. Fácil limpieza y montaje. 220-240V.

Referencia	Potencia	Diámetro	Embalaje
002700014	1500W	Ø185mm	5

Mulix

PLACA ELÉCTRICA

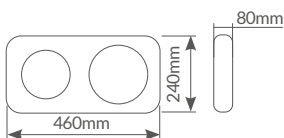

*Sugerencia de presentación.

Placa eléctrica

De **2 quemadores**. Tipo: **portátil**. Luz de encendido y apagado. Con **termostato**. Fácil limpieza y montaje. 220-240V.

Referencia	Potencia	Diámetro	Embalaje
002700015	1000W / 1500W	Ø155mm / Ø185mm	4

Steke

PLANCHA ASAR

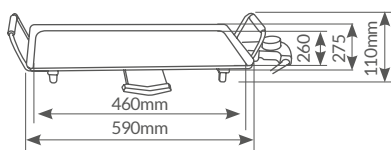

Plancha de asar 2000W

Regulador de temperatura. Temperatura máxima 230°. Superficie **antiadherente**.

Placa de **aluminio**. Asa **toque frío**. **Calentamiento** de forma **uniforme**. Bandeja recoge grasa, desmontable.

Cable alimentación extraíble. Longitud del cable: 1M. Patas **antideslizantes**. 220-240V.

Referencia	Potencia	Superficie útil	Embalaje
400050000	2000W	460x260mm	4

Koes

HORNILLO PORTÁTIL

Funciona con
cartucho
de butano



Potencia
de fuego
regulable

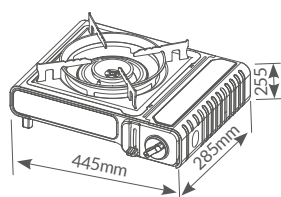

*Sugerencia de presentación.

Hornillo camping gas

Potencia de fuego regulable. Funciona con un cartucho de butano 220gr EN417 (no incluido).

Auto apagado de seguridad. Encendido piezoeléctrico. Consumo: 160g/h.

Tipo: portátil. Fácil limpieza y montaje. Con maletín para su fácil transporte.

Referencia	Potencia	Quemador	Embalaje
400015001	2.2Kw	1	6





A



B



C

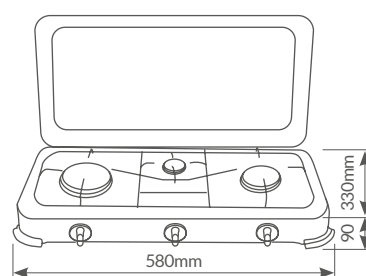
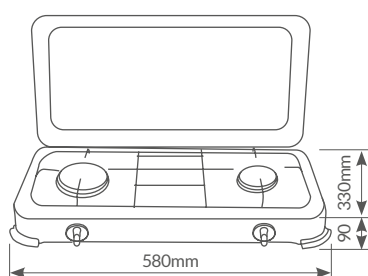
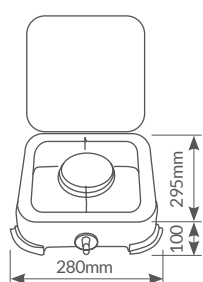

*Sugerencia de presentación.

Hornillo de gas

Alto rendimiento. **Quemador desmontable.** Con tapa para una mejor protección y portabilidad. Con 4 tacos de plástico para lograr una mayor estabilidad. Fácil limpieza y montaje.

Referencia	Artículo	Número quemadores	Quemador/es	Embalaje
002701758	A	1	Ø100mm	1
002701759	B	2	Ø80mm / 100mm	1
002701760	C	3	Ø50mm / Ø80mm / 100mm	1



Valnes

VINOTECA

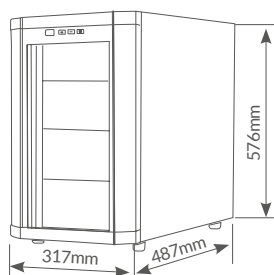

Vinoteca 8 botellas

Control de temperatura (de 4°C a 22°C). **Refrigeración termoeléctrica**. Pantalla LED táctil. Doble cristal. Sistema **antivibración**. Muy silenciosa. Luz interior ON/OFF. Peso: 11.4Kg. 220-240V.

Referencia	Potencia	Capacidad	Embalaje
400080001	64W	8 botellas / 22L.	1



Baklava

BÁSCULA COCINA

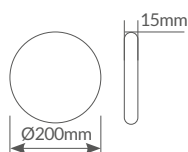

*Sugerencia de presentación.

Báscula de cocina

División en gramos. Pesa en **gramos y mililitros**. Función **tecla tara**. Plataforma de **crystal templado** de 4mm.
Sensor táctil. Con 4 sensores extensométricos de alta precisión. **Pantalla LED.**
 Indicador de batería baja. Incluye una pila CR2032. Fácil limpieza.

Referencia	Capacidad	Embalaje
400000003	5gr. hasta 5Kg.	12

Bambú

BÁSCULA COCINA

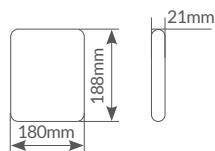

*Sugerencia de presentación.

Báscula de cocina

División en gramos. Pesa en **gramos y mililitros**. Función **tecla tara**. Plataforma de bambú de 6mm.
 Indica el **volumen de la leche y el agua**. **Sensor táctil.** Con 4 sensores de alta precisión. **Pantalla LCD** de 62x28mm.
 Indicador de batería baja y sobrecarga. Utiliza 3 pilas AAA (1.5V), no incluidas. Fácil limpieza.

Referencia	Capacidad	Embalaje
002703058	Hasta 5Kg.	12

Bowly

BÁSCULA COCINA

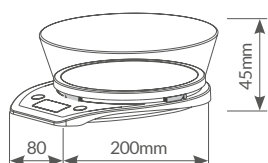

*Sugerencia de presentación.

Báscula de cocina

División en gramos. Pesa en **gramos y mililitros**.

Función **tecla tara**. Indica el **volumen de la leche y el agua**. Bol de plástico para una fácil limpieza y pesado.

Dimensión bol: Ø225x180mm. Con 4 sensores de alta precisión. **Pantalla LCD** de 40x18mm.

Indicador de batería baja y sobrecarga. Utiliza 2 pilas AAA (1.5V), no incluidas. Fácil limpieza y montaje.

Referencia

Capacidad

Embalaje

002703057

5gr. hasta 5Kg.

12

Eclair

BÁSCULA COCINA

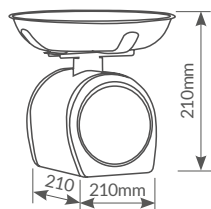

*Sugerencia de presentación.

Báscula de cocina

División en gramos. Función **tecla tara**.

Bol de **acero inoxidable** de 800ml. No necesita pilas. Fácil limpieza.

Referencia	Capacidad	Embalaje
40000001	Hasta 5Kg.	8

Baia

BÁSCULA

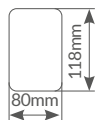

*Sugerencia de presentación.

Báscula de precisión

Función **tecla tara**. Posibilidad de iluminar o no la pantalla. **Calibrado automático**.

Pantalla LCD. **Apagado automático** tras 30seg. de inactividad. Indicador de batería baja.

Usa 2 pilas AAA (incluidas). Alta precisión digital de bolsillo.

Referencia	Capacidad	Embalaje
002701747	0.01gr. hasta 100gr.	25/100



Cuidado personal

PAE

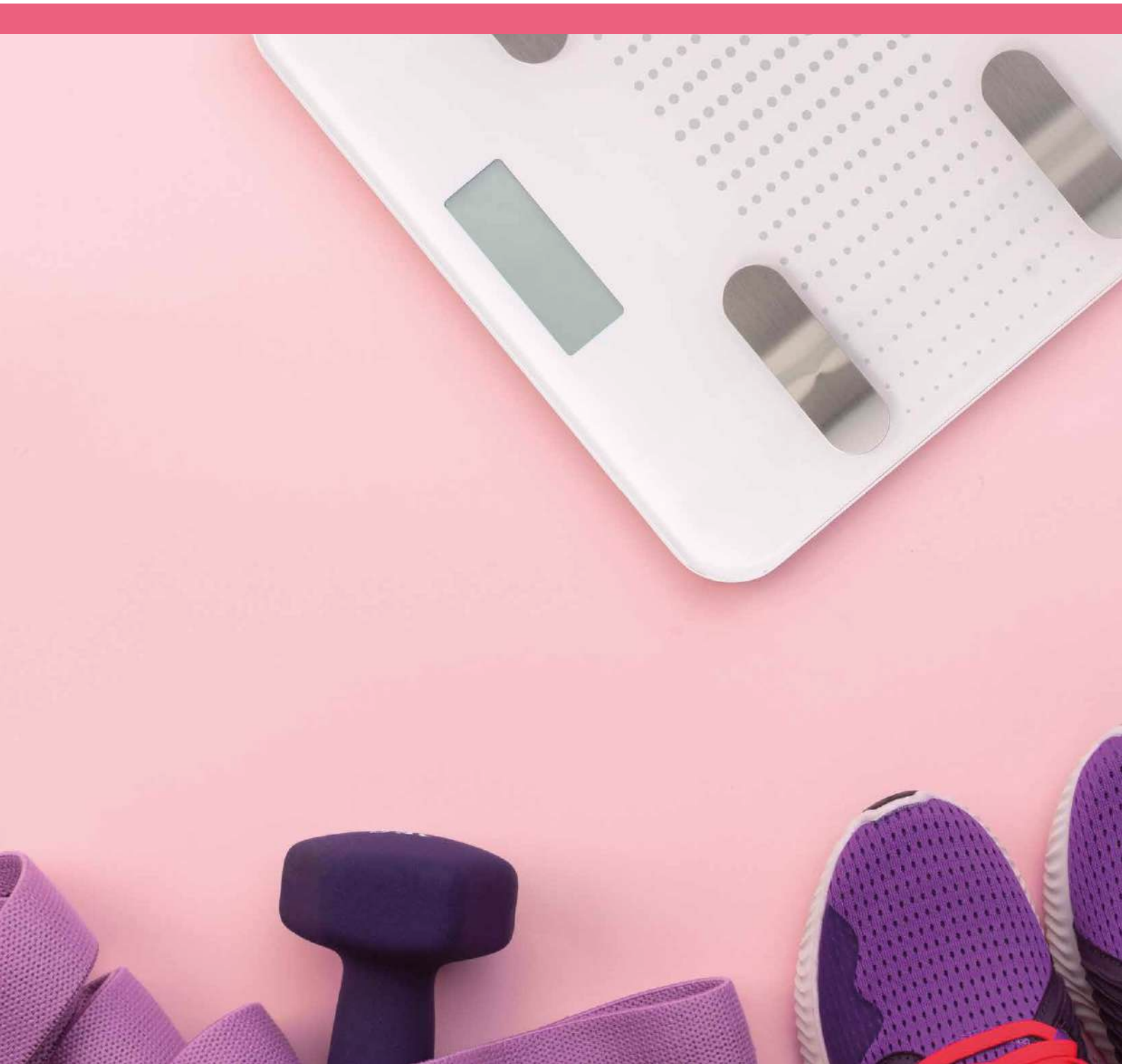

Thaton

BÁSCULA VIAJE

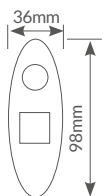

Profundidad: 40mm



*Sugerencia de presentación.

Báscula de viaje

División en gramos. Pantalla LCD. Funciona con una pila CR2032 (incluida). **Apagado automático.**
Material: **ABS.** Con sensores de alta precisión. Ideal para llevar en la maleta de mano.

Referencia	Capacidad	Embalaje
400000004	Máx. 40Kg.	100

Akale

BÁSCULA BAÑO

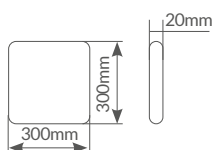

*Sugerencia de presentación.

Báscula de baño

Plataforma de **crystal templado.** **Graduación de 100gr.** Encendido y apagado automático.
Cantos redondeados. **Conversión de unidad Kg y lb.** Alta precisión.
Con 4 sensores de precisión. Pantalla LCD. Indicador de batería baja y sobrepeso.
Incluye una pila CR2032 de litio.

Referencia	Peso máximo	Embalaje
002702418	180Kg.	6



Milak

BÁSCULA BAÑO

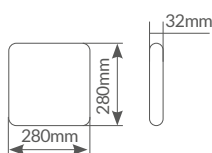

*Sugerencia de presentación.

Báscula de baño

Muestra **13 datos de la biometría** de nuestro cuerpo: **nivel hidratación, grasa, visceral, tasa metabólica basal, índice masa ósea, edad del cuerpo, índice masa corporal, grasa corporal, peso ideal, tasa de proteína, nivel de obesidad, control de peso, peso sin grasa e indicador de peso.** Indica el **consumo de calorías recomendadas.**

Alta precisión. Con 4 sensores de precisión. Plataforma de **crystal templado** alta calidad.

Graduación de 100gr. Encendido y apagado automático. **Memoria para 10 usuarios.**

Modo de peso normal (opcional). Indicador de batería baja y sobrecarga.

Incluye 3 pilas AAA. Cantos redondeados.

Referencia	Peso máximo	Color	Embalaje
400000006	180Kg.	○ Blanco	5
400000005	180Kg.	● Negro	5

Inani

SECADOR

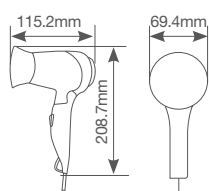

Secador de viaje

Con **2 velocidades**. Con **mango plegable**. Botón On/Off. Material: **PC**. Color: gris/blanco. Incluye anilla para colgar. **Concentrador de aire** incluido. Protección sobrecalentamiento. Ligero y compacto. Ideal para viajes. Longitud cable: 1.8M. 220-240V. 50/60Hz.

Referencia	Potencia	Embalaje
400070002	1200W	24

Libis

SECADOR

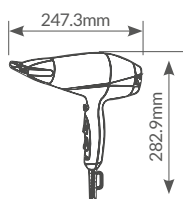

Secador profesional

Con **2 velocidades, concentrador de aire y difusor**. Pulsador de **fase fría instantánea**. Incluye anilla para colgar. Protección sobrecalentamiento. Longitud del cable: 1.8M. 220-240V. 50/60Hz.

Referencia	Potencia	Velocidades	Niveles temperatura	Embalaje
400070000	2000W	2	3	12



Notos

SECADOR

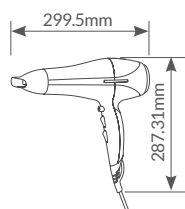

Secador **tourmaline**

Con **2 velocidades, concentrador de aire y difusor**. Tecnología **tourmaline**. Pulsador de **fase fría instantánea**. Incluye anilla para colgar. Protección sobrecalentamiento. Longitud del cable: 1.8M. 220-240V. 50/60Hz.

Referencia	Potencia	Velocidades	Niveles temperatura	Embalaje
400070001	2200W	2	3	12



Set afeitado 7 en 1

Incluye **cabezal amplio, cabezal de detalle, recortador de pelos nasal y orejas, micro afeitadora, peine guía 0.5-10mm, peine guía 10.5-20mm, peine doble, cepillo, aceite**. Material: cuchillas de **acero inoxidable**. Interruptor ON/OFF.
Autonomía: 1h. **Tiempo de carga:** 2 horas. Con batería de litio 500mAh 3.2V recargable. Cable USB de 0.5M a cable tipo C incluido.

Referencia	Cabezales	Embalaje
400020001	4	12



Cortapelos nasal y orejas

Con cabezal protector. **IPX4**. Funciona a pilas. Usa 1 pila AA (no incluida).

Referencia	Embalaje
002703004	40





Cuchillas rotatorias para máquina de afeitar

EQUIVALENCIA

HS105	HS165	HS308	HQ22	HQ200	HQ2405
HS110	HS250	HS345	HQ220	HQ202	HQ242
HS106	HS250A	HS346	HQ26	HQ203	HQ2425
HS125	HS250B	HS260B	HQ262	HQ220	HQ26
HS135	HS255B	HS708	HQ282	HQ222	HQ2610
HS155	HS255A	HQ20	HQ283	HQ240	HQ2830
					HQ284

Referencia	Para modelo	Blíster	Embalaje
002703026	HQ2	3Ud.	10



Cuchillas rotatorias para máquina de afeitar

EQUIVALENCIA

HQ380	HQ386	HQ36	HQ30	HQ320
HQ382	HQ322	HQ360	HQ300	
HQ384	HQ3445	HQ3605	HQ304	

Referencia	Para modelo	Blíster	Embalaje
002703027	HQ3	3Ud.	10



Cuchillas rotatorias para máquina de afeitar

EQUIVALENCIA

HQ40	HQ422	HQ488	HQ4441	HQ4805	HQ4856
HQ41	HQ441	HQ489	HQ4445	HQ4806	HQ4861
HQ4406	HQ442	HQ4401	HQ4601	HQ4825	HQ4865
HQ42	HQ443	HQ4405	HQ4607	HQ4826	HQ4866
HQ46	HQ444	HQ4406	HQ4608	HQ4830	HQ4870
HS190	HQ448	HQ4407	HQ4609	HQ4845	HQ4885
HQ402	HQ460	HQ4411	HQ4610	HQ4846	HQ4890
HQ404	HQ468	HQ4421	HQ4625	HQ4847	
HQ406	HQ481	HQ4425	HQ4630	HQ4850	
HQ420	HQ485	HQ4440	HQ4800	HQ4851	

Referencia	Para modelo	Blíster	Embalaje
002703028	HQ4	3Ud.	10



Cuchillas rotatorias para máquina de afeitar

EQUIVALENCIA

HQ3805	HQ4405	HQ4845	HQ5815	HQ6696	HS766
HQ3810	HQ4411	HQ4850	HQ6605	HQ6849	HS775
HQ3825	HQ4425	HQ4865	HQ6640	HQ6854	HS800
HQ3830	HQ4445	HQ4885	HQ6645	HS3850	HS850
HQ3845	HQ4806	HQ4890	HQ6675	HS715	HS875
HQ3865	HQ4810	HQ5430	HQ6676	HS755	HS900
HQ3870	HQ4830	HQ5812	HQ6695	HS765	HS950

Referencia	Para modelo	Blíster	Embalaje
002703029	KQ55	3Ud.	10

*Recambio genérico de cuchilla rotatoria para máquina de afeitar creada para los modelos PHILIPS.



Hogar y bienestar

PAE



Bhapur

PLANCHA



Suela antiadherente

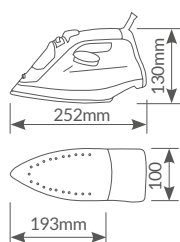

Plancha de vapor 2000W

Temperatura **regulable**.

Funciones de planchado: **en seco, spray, vapor regulable, ráfaga de vapor y vapor regulable y pulverización**.

Suela **antiadherente**. Depósito de agua translúcido con **tapa de seguridad**. Cable protector con giro de 360°.

Botón **autolimpieza**. Indicador luminoso. Cable 1.9M. 230V.

Referencia	Potencia	Capacidad	Embalaje
400055010	2000W	200ml.	10

Parou

PLANCHA



Suela
antiadherente

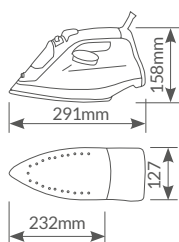

Plancha de vapor 2200W

Temperatura **regulable**. Sistema **anti cal** y **antigoteo**.

Funciones de planchado: **en seco**, **spray**, **vapor regulable**, **ráfaga de vapor** y **vapor regulable** y **pulverización**.

Suela **antiadherente**. Depósito de agua translúcido con **tapa de seguridad**. Cable protector con giro de 360°.

Botón **autolimpieza**. Indicador luminoso. Cable 1.9M. 230V.

Referencia	Potencia	Capacidad	Embalaje
400055006	2200W	300ml.	10



Dampf

PLANCHA

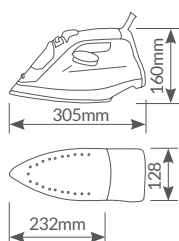

Plancha de vapor 2600W

Temperatura **regulable**. Sistema **anti cal** y **antigoteo**.

Funciones de planchado: **en seco**, **spray**, **vapor regulable**, **ráfaga de vapor** y **vapor regulable** y **pulverización**.

Suela **revestimiento cerámico**. Depósito de agua **translúcido** con **tapa de seguridad**. Cable protector con giro de 360°.

Botón **autolimpieza**. Indicador luminoso. Cable 2.15M. 230V.

Referencia	Potencia	Capacidad	Embalaje
400055007	2600W	300ml.	10

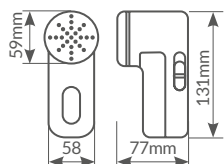

Quita pelusas

Depósito extraíble. Con **parada automática de seguridad**. Material **ABS y acero**. Diseño robusto y ligero. Incluye tapa y cepillo limpiador. **2 velocidades** (6000-7500rpm). Botón ON/OFF. Pilas no incluidas.

Referencia	Velocidades	Pilas	Embalaje
400055008	2	2 x AA	60

Dubie

ASPIRADOR



Función
soplado

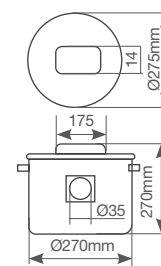

Aspirador de cenizas

Filtro Hepa. Con bolsa-filtro de **tela infuga**. Función **soplado y aspiración**. Sistema fácil vaciado. **4 accesorios**: tubo de aluminio, tubo flexible, filtro HEPA y bolsa-filtro tela infuga. Material: **aluminio, metal y plástico**. Con asa. Cable: 1.5M. 220-240V.

Referencia	Potencia	Capacidad	KPA	Decibelios	Embalaje
400085003	800W	10L.	15Kpa	80dB	1





Dolisie

ASPIRADOR



*Sugerencia de presentación.

Aspirador mult ciclónico

Filtro Hepa. Sin bolsa. Para **todo tipo de suelos.** Sistema fácil vaciado. **5 accesorios:** cepillo para suelo (255x200mm), 2 tubos rígidos (Ø35x400mm), cepillos para esquinas, filtro Hepa y tubo flexible (Ø35x1800mm). Material: **PP+ABS.** Recogecables automático **4.8M.** Con asa y 2 ruedas de plástico. 220-240V.

Referencia	Potencia	Capacidad	Embalaje
400085001	700W	3L.	1

Oyem

ASPIRADOR

*Sugerencia de presentación.

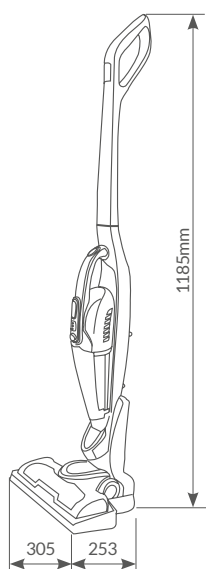

Aspirador de escoba 2 en 1

Filtro lavable atrapa polvo. **Cepillo eléctrico** con LED. Para **todo tipo de suelos**. Sistema fácil vaciado. **6 accesorios**: cepillo (260x175mm), rodillo para el cepillo, filtro y soporte para filtro, cepillos para rincones, cargador 27V 500mA, soporte para cargador. **Autonomía**: 20-40min. **Tiempo de carga**: 4h. Incluye cargador con 1.8M de cable. **Batería** 22.2V / 2200mAh. Material: ABS. **Sin bolsa y sin cables**.

Referencia	Potencia	Capacidad	Embalaje
400085002	120W	0.5L.	4





Kalera

SECADOR DE ROPA



*Sugerencia de presentación.

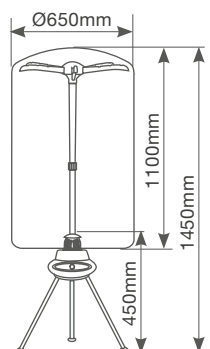

Secador de ropa **portátil**

Incluye **perchero** y **cube-perchero**. Ocupa poco espacio. **Apagado automático**. **Anti-bacterias**. Indicador luminoso. Fácil montaje/desmontaje. **Temporizador de 30 a 180min**. Material: **aluminio, plástico y poliéster**. 220-240V.

Referencia	Potencia	Capacidad	Decibelios	Embalaje
301030002	1000W	10Kg	<40dB	4

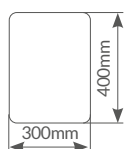

Almohadilla eléctrica lumbar

Mando con 3 niveles de temperatura. **100% poliéster.**
Indicada para **reumatismo, lumbalgias** y procesos inflamatorios en general.
Con **mando desmontable** para lavar la almohadilla cómodamente.
Protección contra sobrecalentamiento. Cable: 2.3M. 220-240V.

Referencia	Potencia	Niveles temp.	Embalaje
400060003	100W	3	20

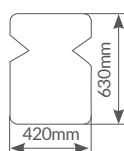

Almohadilla eléctrica cervical

Mando con 3 niveles de temperatura. **100% poliéster.**
Indicada para **reumatismo, lumbalgias** y procesos inflamatorios en general.
Con **mando desmontable** para lavar la almohadilla cómodamente.
Protección contra sobrecalentamiento. Cable: 2.3M. 220-240V.

Referencia	Potencia	Niveles temp.	Embalaje
400060004	100W	3	20

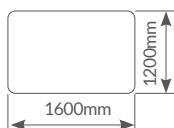

Manta eléctrica 120W

Con un mando con 3 niveles de temperatura. Material: **franela**. Rápido calentamiento.

Indicada para **reumatismo, lumbalgias** y procesos inflamatorios en general.

Con **mando desmontable** para lavar la manta cómodamente. Protección contra **sobrecalentamiento**.

Con indicador LED y botón On/Off. **Apagado automático a las 3h**. Cable: 1.6M. 220-240V.

Referencia	Potencia	Niveles temp.	Embalaje
400060009	120W	3	10

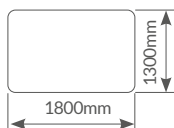

Manta eléctrica 160W

Con un mando con 10 niveles de temperatura. Material: **franela + forro de lana sintética**. Rápido calentamiento.

Indicada para **reumatismo, lumbalgias** y procesos inflamatorios en general. Con **mando desmontable** para lavar la manta cómodamente. Protección contra **sobrecalentamiento y sistema PTC y NTC**. Con indicador LED y botón On/Off.

Apagado automático de 1h. a 12h. Cable: 1.6M. 220-240V.

Referencia	Potencia	Niveles temp.	Embalaje
400060010	160W	10	4

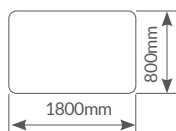

Calentador de cama **eléctrico sencillo**

Con mando con 2 niveles de temperatura. **100% poliéster.**

Indicada para **reumatismo, lumbalgias** y procesos inflamatorios en general. Con **mando desmontable** para lavar el calentador cómodamente. Protección contra **sobrecalentamiento**. Con indicador LED. Cable: 2.3M. 220-240V.

Referencia	Potencia	Niveles temp.	Embalaje
400060005	60W	2	6

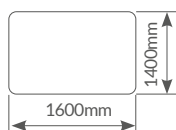

Calentador de cama **eléctrico doble**

Con 2 mandos con 2 niveles de temperatura. **100% poliéster.**

Indicada para **reumatismo, lumbalgias** y procesos inflamatorios en general. Con **mando desmontable** para lavar el calentador cómodamente. Protección contra **sobrecalentamiento**. Con indicador LED. Cable: 2.3M. 220-240V.

Referencia	Potencia	Niveles temp.	Embalaje
400060006	2x60W	2	6



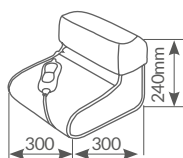

Calientapiés eléctrico 100W

Con un mando con 3 niveles de temperatura. Material: **funda microfelpa + forro de lana sintética**. Rápido calentamiento. Válido para pies de hasta la talla 47. **Forro lavable**. Protección contra **sobrecalentamiento**. Con indicador LED y botón On/Off. **Apagado automático a los 90min**. Cable: 1.6M. 220-240V.

Referencia	Potencia	Niveles temp.	Embalaje
400060008	100W	3	10

Solepur CALENTADOR



Se carga en sólo
3 minutos

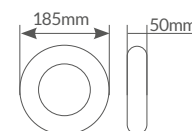

Calentador eléctrico portátil

100% seguro. Indicador luminoso de encendido. Cable de carga: 0.8M. Incluye bolsa de forro polar. El sustituto perfecto de las bolsas de agua tradicionales. Protección contra sobrecalentamiento. 220-230V.

Referencia	Potencia	Autonomía	Tiempo de carga	Embalaje
301030001	Máx. 550W	3h.	3 min.	12



A



B



C



D



E



F



G

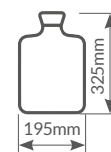

Bolsa de agua caliente

Cómoda y práctica.

Referencia	Artículo	Motivo	Capacidad	Funda	Color	Embalaje
400060011	A	Oveja	2L.	Lana	○ Blanco	25
400060017 ★	B	Zorro	2L.	Lana	● Rojo	25
400060018 ★	C	Escocés	2L.	Lana	● Rojo/Azul/Blanco	25
301030003 ★	D	Escocés	2L.	Lana	● Rojo/Negro/Gris	24
400060019 ★	E	Lisa	2L.	Lana	● Azul	25
400060000	F	Zig-Zag	2L.	Punto	● Gris / Blanco	25
400060007	g	Zig-Zag	2L.	Polyester	● Gris	25



Bolitas de arcilla de Ø3mm

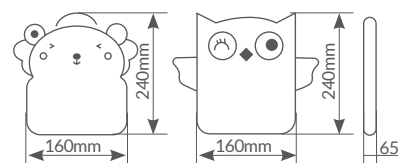

Saco térmico de bolitas de arcilla

Material: funda de algodón. Bolitas de arcilla de Ø3mm.

Ideal para para aliviar diferentes tipos de dolor mediante su uso a través del calor seco. Cómoda y práctica.

Referencia	Motivo	Para	Embalaje
301030004	León	Microondas	24
301030005	Buho	Microondas	24



Ocupa muy poco espacio



Bolitas de arcilla de Ø3mm



480x140mm

Saco térmico de bolitas de arcilla

Material: funda de poliéster. Bolitas de arcilla de Ø3mm.

Ideal para para aliviar diferentes tipos de dolor mediante su uso a través del calor seco. Cómoda y práctica.

Referencia	Para	Color	Embalaje
400060020	Microondas	● Aguamarina	12



Equipamiento de cocina

Menaje





Sartén aluminio forjado

Grosor **4mm**. 2 capas. **Antiadherente y ecológica**. Libre de PFOA. **Aptas para todo tipo de cocinas**. Mango de silicona ergonómico. Efecto: **piedra granito**. Fácil limpieza.

Referencia	Diámetro	Embalaje
002702560	Ø180mm	6
002702562	Ø220mm	6
002702565	Ø280mm	6



Sartén aluminio forjado

Grosor **base 5mm / cuerpo 2mm**. **Antiadherente y ecológica**. Libre de PFOA. **Aptas para todo tipo de cocinas**. Especial **inducción rápida**. Mango tacto suave. Mayor superficie útil. Con **medidor de aceite**. Fácil limpieza.

Referencia	Diámetro	Embalaje
401035000	Ø200mm	6
401035001	Ø240mm	6
401035002	Ø280mm	6



Sartén Pro aluminio forjado

Grosor **base 5.7mm / cuerpo 2mm. Antiadherente y ecológica.** Libre de PFOA. **Aptas para todo tipo de cocinas.** Especial **inducción rápida.** Mango tacto suave. Mayor superficie útil. Con **medidor de aceite.** Fácil limpieza.

Referencia	Diámetro	Embalaje
401035003	Ø200mm	6
401035005	Ø280mm	6



Sartén grill aluminio forjado

Grosor **4.8mm. 2 capas. Antiadherente y ecológica.** Libre de PFOA. **Aptas para todo tipo de cocinas.** Mango de silicona ergonómico. Efecto: **piedra granito.** Fácil limpieza.

Referencia	Dimensión	Embalaje
002702566	280x280mm	1





Paellera honda esmaltada con asas

Hecho en **acero esmaltado de alta calidad**. Bordes redondeados. Apta para todo tipo de fuegos.

Referencia	Diámetro	Embalaje
401025001	Ø280mm	6
401025002	Ø320mm	6
401025003	Ø360mm	4
401025004	Ø400mm	4



Tapa universal silicona para ollas y sartenes

Material: **silicona y cristal**. Con válvula de vapor. Pomo resistente a altas temperaturas. Apto para lavavajillas.

Referencia	Para sartenes	Embalaje
401015008	Ø160 / Ø180 / Ø200mm	16
401015009	Ø200 / Ø220 / Ø240mm	16
401015010	Ø240 / Ø260 / Ø280mm	16





- Capacidad **máxima**
- Capacidad **media**
- Capacidad **fin** (Valenciana)



Paellera **acero pulido**

La auténtica paellera valenciana. Para **cocina tradicional**.
Material: **acero pulido**. 3 años de garantía.

Referencia	Raciones capacidad máx.	Raciones capacidad media	Raciones capacidad fina	Diámetro	Embalaje
401025000	4	2-3	1	Ø300mm	6
002701792	6	3-5	2	Ø340mm	6
002701793	7-8	4-6	2-3	Ø380mm	6
002701794	9-10	5-8	3-4	Ø420mm	6
002701795	11-12	6-10	4-5	Ø460mm	4
002701796	14-16	8-13	5-7	Ø550mm	4
002701797	16-20	9-15	6-8	Ø600mm	4



- Capacidad **máxima**
- Capacidad **media**
- Capacidad **fin** (Valenciana)



Paellera acero esmaltado

La auténtica paellera valenciana. Para **cocina tradicional**.
Material: **acero esmaltado**. 3 años de garantía.

Referencia	Raciones capacidad máx.	Raciones capacidad media	Raciones capacidad fina	Diámetro	Embalaje
002701798	4	2-3	1	Ø300mm	6
002701799	7	4-5	2-3	Ø360mm	6
002702515	8-9	5-7	2-4	Ø400mm	6
002702516	12-14	7-11	4-6	Ø500mm	4
401025005	14-16	8-13	5-7	Ø550mm	4
401025006	16-20	9-15	6-8	Ø600mm	4
401025007	20-25	12-19	7-11	Ø650mm	2



- Capacidad **máxima**
- Capacidad **media**
- Capacidad **fina** (Valenciana)



Paellera pulida vitro

La auténtica paellera valenciana. Para **inducción** y **vitrocerámica**.
Material: acero pulido. 3 años de garantía.

Referencia	Raciones capacidad máx.	Raciones capacidad media	Raciones capacidad fina	Diámetro	Embalaje
002702517	5	3-4	1-2	Ø320mm	6
002702518	6	3-5	2	Ø340mm	6
002702519	7	4-5	2-3	Ø360mm	6

Exprés

RÁPIDA



Equipamiento de cocina Baterías



4L.

6L.

8L.

10L.

Olla exprés rápida

Material: **18/8 acero inoxidable**. 2 sistemas de seguridad.
Aptas para todo tipo de cocinas. No absorbe olores ni sabores. Fácil limpieza.

Referencia	Capacidad	Diámetro	Embalaje
002702567	4L.	Ø220mm	4
002702568	6L.	Ø220mm	4
002702569	8L.	Ø240mm	4
002702570	10L.	Ø240mm	4
002703166	Recambio junta silicona Ø220mm		
002703167	Recambio junta silicona Ø240mm		
002703168	Recambio asas para olla		
002703169	Recambio pomo		
002703170	Recambio válvula		
002703171	Recambio chimenea		

Exprés

ULTRA RÁPIDA



Equipamiento de cocina Baterías

Olla exprés ultra rápida

Material: **18/8 acero inoxidable**. 3 sistemas de seguridad.
Aptas para todo tipo de cocinas. No absorbe olores ni sabores. Fácil limpieza.

Referencia	Capacidad	Diámetro	Embalaje
002702571	4L.	Ø220mm	4
002702572	6L.	Ø220mm	4
002702573	8L.	Ø240mm	4
002703172	Recambio junta silicona Ø220mm		
002703173	Recambio junta silicona Ø240mm		
002703174	Recambio parte superior del asa grande		
401060003	Recambio parte inferior del asa grande		
002703175	Recambio asa cuerpo tapa para ollas		
002703176	Recambio válvula		
002703177	Recambio chimenea		



A



B



C



D

Quemadores de gas

Distribuye de manera uniforme el gas.

Referencia	Artículo	Diámetro	Aros	Paellero compatible	Embalaje
401025008	A	Ø200mm	1	Ø260x360mm	1
401025009	A	Ø300mm	1	Ø360x420mm	1
401025010	B	Ø300mm	2	Ø200x420mm	1
401025011	B	Ø350mm	2	Ø200x500mm	1
401025012	C	Ø400mm	2	Ø260x600mm	1
401025013	C	Ø500mm	2	Ø360x700mm	1
401025014	D	Ø600mm	3	Ø260x800mm	1
401025015	D	Ø700mm	3	Ø360x900mm	1



Trípode regulable para quemador

Tipo: **plegable.**

Referencia	Embalaje
002702523	5



Soporte 3 patas para quemador

Juego 3 patas redondas para quemador.

Referencia	Embalaje
002702524	5





A



B



C

Goma de butano

Distribuye de manera uniforme el gas.

Referencia	Artículo	Tipo	Longitud	Abrazaderas	Embalaje
002702525	A	Kit goma butano corta	0.8M	2	1
002702526	A	Kit goma butano larga	1.5M	2	1
002702527	B	Rollo goma de butano	60M	-	1
401005002	C	Regulador de gas con goma de butano	0.8M	-	1



Regulador de gas

Para goma de butano.

Referencia	Embalaje
002702528	50



Abrazadera

Para goma de butano. Caja de 100 unidades.

Referencia	Embalaje
002702557	100/1600



Carro porta bombonas de gas butano



Ruedas inyectadas. Material: **poliamida y fibra de vidrio**.
 Diámetro exterior: Ø320mm. Diámetro interior: Ø240mm.

Referencia	Soporta hasta	Color	Embalaje
401005000	50Kg	● Naranja	14

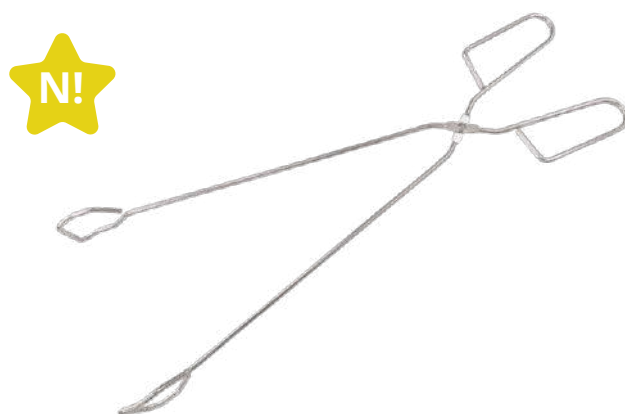

Pinzas barbacoa

Material: **acero zincado**.

Referencia	Longitud	Grosor	Embalaje
401000003	260mm	Ø4mm	48
401000002	400mm	Ø4mm	48

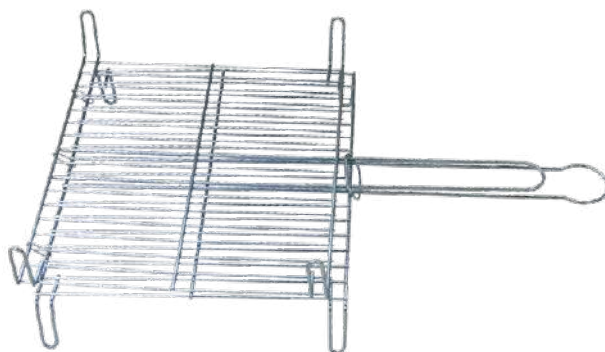

Parrilla barbacoa

Material: **acero zincado**. Con 4 patas.

Referencia	Dimensión	Embalaje
002702530	300x350mm	12
002702531	400x450mm	12

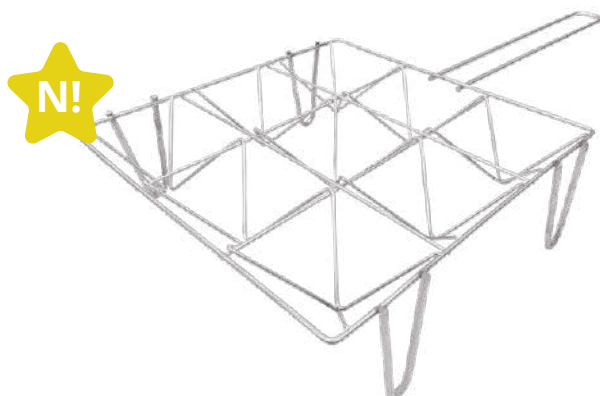

Parrilla para verduras

Material: acero zincado. Con 4 patas.

Referencia	Dimensión	Embalaje
401000001	260x260mm	12

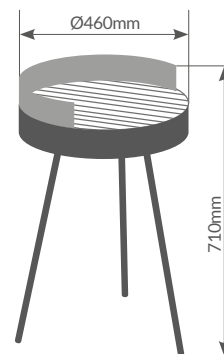

Barbacoa portátil de carbón

Material: **acero esmaltado** y pantalla de **acero inoxidable**.
 Con pestañas de seguridad. **4 alturas de cocinado**.
 Fácil montaje, sin herramientas. Peso: 3Kg.

Referencia	Rejilla	Altura	Embalaje
002702574	Ø430mm	710mm	1





Instrumentos de cocina

Menaje





A



B



C



D



Utensilios madera de bambú

Fácil limpieza. **Apto para lavavajillas.** Bolsa 10 unidades.

Referencia	Artículo	Tipo	Longitud	Embalaje
002702576	A	Cuchara	30cm	10/400
002702577	B	Tenedor	30cm	10/400
002702578	C	Espátula	30cm	10/400
002703144	D	Espátula curva	30cm	10/400



A

B

C

D

E

F

Utensilios de nylon

Fácil limpieza. Mango antiadherente. No raya. **Apto para lavavajillas.**

Referencia	Artículo	Tipo	Longitud	Embalaje
401045012	A	Cazo	34cm	24/48
401045013	B	Cuchara	34cm	24/48
401045014	C	Cuchara de pasta	34cm	24/48
401045015	D	Espumadera	36cm	24/48
401045016	E	Espátula	35cm	24/48
401045017	F	Espátula fina	33cm	24/48



Soporte para cucharas cocina

Material: **PP**. Colores surtidos. Pack 12 unidades.

Referencia	Dimensión	Embalaje
401045029	200x90x40mm	12



Set 3 boles de plástico

Material: **PP**. Colores surtidos.

Referencia	Tamaños	Embalaje
401045027	3	10





Plato vuelca tortillas

Material: **PP**. Colores surtidos. Pack 12 unidades.

Referencia	Dimensión	Embalaje
401015007	Ø295x47mm	12



Tapa microondas con válvula

Material: **PP**. Colores surtidos. Pack 12 unidades.

Referencia	Dimensión	Embalaje
401015006	Ø250x90mm	60



Cesta de silicona para freidora sin aceite

Material: **silicona**. Plegable.

Referencia	Artículo	Dimensión	Embalaje
400091001	A	Ø211mm	48
400091002	B	204x204mm	48



Escurridor ovalado con mango



Material: **PP**. Colores surtidos. Pack 12 unidades.

Referencia	Dimensión	Embalaje
401045006	260x225x115mm	36



Tijera de cocina

Fácil limpieza. **Apto para lavavajillas.**

Referencia	Longitud	Material	Embalaje
401010001 ★	21cm	Acero inoxidable + Mango PP	12/144



Tijera de cocina

Fácil limpieza. **Apto para lavavajillas.**

Referencia	Longitud	Material	Embalaje
002703164	18.5cm	Acero inoxidable	12/96

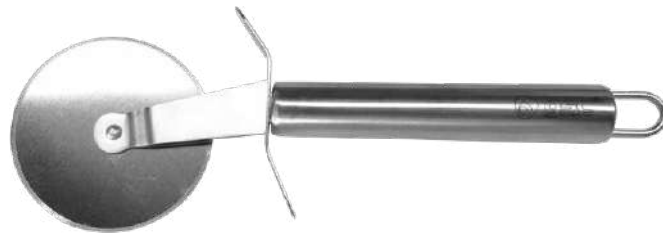

Corta pizzas

Fácil limpieza. **Apto para lavavajillas.**

Referencia	Material	Embalaje
002701775	Acero inoxidable	12/72



Pelador horizontal

Fácil limpieza. **Apto para lavavajillas.**

Referencia	Material	Embalaje
002701776	Acero inoxidable	12/72





Pelador vertical

Fácil limpieza. **Apto para lavavajillas.**

Referencia	Material	Embalaje
002701777	Acero inoxidable	12/72



Rallador multifunción 4 caras

Material: superficie de **acero inoxidable**. **4 caras de rallado**. Fácil limpieza.

Referencia	Dimensión	Embalaje
401010002	103x80x235mm	12/72

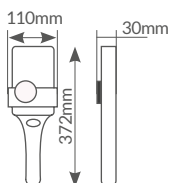

Mandolina de mano 4 cuchillas

Material: **acero inoxidable**, ABS + TPE. Mango ergonómico.

Tipos de corte: **corte juliana, rallado fino, rallado grueso y corte grueso**. Grosor de corte graduable. Fácil limpieza.

Referencia	Nº de cuchillas	Embalaje
401010004	4	12/72

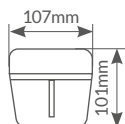

Picadora manual 400ml

Material: **acero inoxidable**, PP, PS + TPE. Tirador plegable.

Cuchilla y recipiente apto para lavavajillas. Fácil limpieza.

Referencia	Capacidad	Embalaje
401010003	400ml	12/72



Tabla corte bambú para pan

Material: **bambú**. Doble bandeja recogemigas. Cómoda, práctica y duradera.

Referencia	Dimensión	Embalaje
401045001	360x250x18mm	96



Tabla corte de bambú

Material: **bambú**. Cómoda, práctica y duradera.

Referencia	Dimensión	Embalaje
401045000	379x215x10mm	96



Tabla de corte

Material: **PP**. Cómoda, práctica y duradera. **Apta para lavavajillas**.

Referencia	Dimensión	Embalaje
002703117	290x190x4mm	96
002703118	370x250x5mm	36

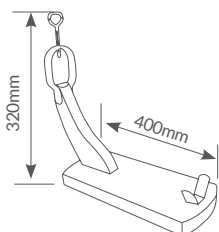

Jamonero de madera

Material: **madera pino**. Pintura termolacada. Lacado sin tóxicos.

Referencia	Grosor madera	Embalaje
401065001	25mm	1



Sacacorchos clásico

Cómodo, fácil y sencillo.
Un utensilio indispensable en todas las cocinas.

Referencia	Embalaje
002701784	12/72



Sacacorchos camarero

Cómodo, fácil y sencillo.
Un utensilio indispensable en todas las cocinas.

Referencia	Embalaje
002701785	12/72



Abridor botellín clásico

Cómodo, fácil y sencillo.
Un utensilio indispensable en todas las cocinas.

Referencia	Embalaje
002701786	24/144



Abridor botellín camarero

Cómodo, fácil y sencillo.
Un utensilio indispensable en todas las cocinas.

Referencia	Embalaje
002701787	6/72



Abrelatas clásico

Cómodo, fácil y sencillo.
Un utensilio indispensable en todas las cocinas.

Referencia	Embalaje
002701788	50/500



Cascanueces

Las cáscaras quedan recogidas gracias a su forma cónica.
También puedes **abrir botellas de cava** con este cascanueces.

Referencia	Embalaje
002701790	12/48



155x43x22mm

Cascanueces clásico

Cómodo, fácil y sencillo. Material: acero.
Un utensilio indispensable en todas las cocinas.

Referencia	Embalaje
401045026	12/72

Sievi

SACACORCHOS

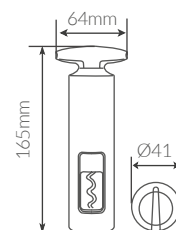

Sacacorchos de rosca

Incluye **cuchilla cortaláminas**. Material: **ABS**.

Referencia	Tipo	Color	Embalaje
401070003	Manual	● Negro	72

Ninda

SACACORCHOS

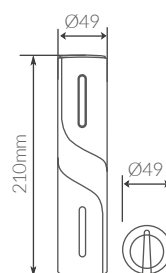

Sacacorchos automático

Recargable 3.6V 100-240V~ 50/60Hz. Batería **NI-MH**. Silencioso.
Después de una recarga completa **puede abrir hasta 30 botellas**. Incluye **cuchilla cortaláminas**.
Cable USB incluido 0.8M. Material: **ABS + PC**.

Referencia	Tipo	Color	Embalaje
401070001	Automático	● Negro	36
401070002	Automático	● Rojo	36



Set sacacorchos automático + tapón de vacío + servidor de vino

Después de una recarga completa **puede abrir hasta 30 botellas**. Incluye **cuchilla cortaláminas, tapón de vacío y servidor de vino**.
Material: **ABS + PC**. Funciona con pilas: 4 x AA (1.5V). No incluidas.

Referencia	Tipo	Color	Embalaje
401070007	Automático	● Negro	24



Bomba de vacío con 4 tapones

Para botellas de vino. Material: **ABS y silicona alimentaria**.

Referencia	Con	Color	Embalaje
401070005	Registro de fecha	● Negro	150

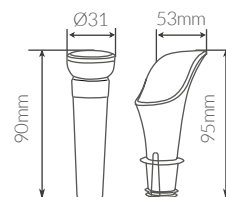

Set 4 piezas: sacacorchos + bomba + servidor + anillo antigoteo

Para botellas de vino. Material: **acero inoxidable, plástico y acrílico.**

Referencia	Incluye	Color	Embalaje
401070008	Sacacorchos, bomba de vacío, servidor de vino y anillo antigoteo	● Negro	72

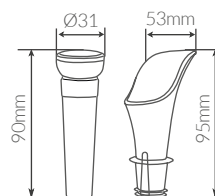

Set tapón de vacío + servidor de vino

Para botellas de vino. Material: **ABS.**

Referencia	Color	Embalaje
401070004	● Negro	150

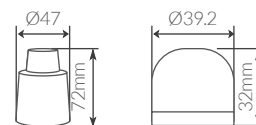
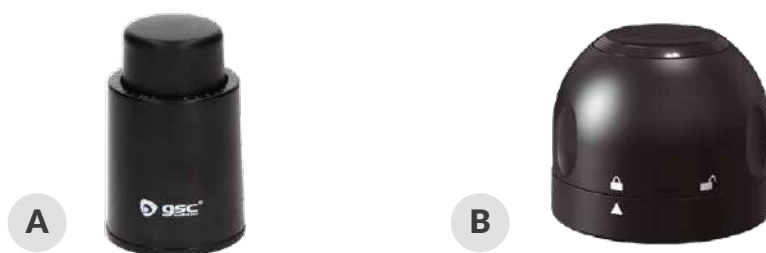

Tapones de vino y champán

Material: **ABS y silicona alimentaria**. Color: negro.

Referencia	Artículo	Descripción	Con	Embalaje
401070012	A	Tapón vacío para vino	Registro de fecha	144
401070006	B	Tapón hermético para champán	Botón bloqueo	200



*Sugerencia de presentación.

Enfriadores de vino

Para botellas de vino. Color: negro.

Referencia	Artículo	Material	Funda ajustable	Embalaje
401070009	A	Nylon	Con elásticos laterales	24
401070010	B	PVC	Con 2 cierres de velcro	40



Exprimidor manual

Material: **PP**. Dimensión: Ø150x100mm.
Colores surtidos. Pack 12 unidades.

Referencia	Capacidad	Embalaje
400025002	650ml.	72



Exprimidor manual

Material: **plástico**. Dimensión: Ø124x190mm. Color transparente y coral. Pack 12 unidades.

Referencia	Capacidad	Embalaje
401030028	740ml.	12





Set 3 embudos de plástico

Colores surtidos. Pack 6 unidades.

Referencia	Material	Embalaje
401045007	PP	36

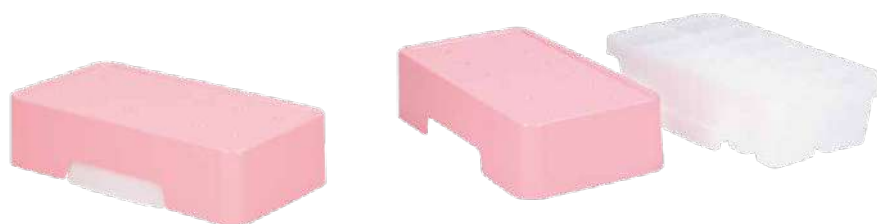

Cubitera con tapa 12 cubitos

Tipo: rectangular. Material: **PP/LDPE**.
Dimensión: 220x120x54mm. Colores surtidos. Pack 12 unidades.

Referencia	Dimensión cubito	Embalaje
401030025	47x55mm	12



Cubitera con tapa 6 cubitos

Tipo: rectangular. Material: **PP/LDPE**. Para hacer hielos grandes.
Dimensión: 305x57x60mm. Colores surtidos. Pack 12 unidades.

Referencia	Dimensión cubito	Embalaje
401030005	45x50mm	84

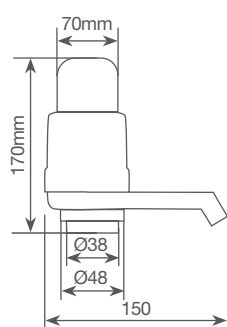

Dispensador de agua 5L / 8L

Olvida tener que coger garrafas para dispensar el agua. Cómodo y práctico.

Referencia	Para botellas de	Embalaje
002701783	5L. / 8L.	24





Dispensador agua automático para botellas de 5L / 10L

Olvida tener que coger garrafas para dispensar el agua. Materia: **silicona, acero inox. + PP.**

Caudal: 1500ml/min. Para botellas de Ø37mm, Ø48mm y Ø58mm. **Cable USB** 50cm (incluido). Batería 1200mAh 5V. Cómodo y práctico.

Referencia	Para botellas de	Embalaje
401045011	5L. / 10L.	50

Konia

TERMO



Termo de acero inoxidable

Doble pared con **cámara de vacío**. Con tapón vertedor. Material: **acero inoxidable**.

Referencia	Capacidad	Embalaje
002703125	350ml.	24
002703126	500ml.	24
002703127	750ml.	24
002703128	1000ml.	24



Termo de acero inoxidable

Doble pared con **cámara de vacío**. Con **filtro**.
Material: **acero inoxidable**.

Referencia	Capacidad	Embalaje
401040000	450ml.	24



Botella agua de tritán 600ml.

Material: **tritán**. Apto para lavavajillas 100°C y microondas.
Congelación hasta -40°C. A prueba de fugas.

Referencia	Capacidad	Embalaje
401030019	600ml.	24



A



B

Porta bocadillos reutilizable ecológico

Material: **poliéster y forro de PEVA**. Lavable y antimanchas. Libre de **BPA**. Cierre con **velcro ajustable**.
Ahorro en envoltorios y **cuida el medio ambiente**. Fácil, sencillo, cómodo y práctico.

Referencia	Artículo	Tipo	Dimensión abierto	Embalaje
401030031	A	Estampado	540x320mm	360
401030032	B	Aguamarina	540x320mm	360



A



B



C



D



Bolsa térmica porta alimentos 5L.

230x110x260mm

Material: **poliéster y forro de PEVA**. Con **asa superior**. Incluye **3 bolsillos**: uno exterior **con cremallera**, otro **lateral tipo rejilla** y uno interior con una **rejilla** para guardar los cubiertos. Ideal para **mantener el calor o el frío** de los alimentos. Gran resistencia.

Referencia	Artículo	Capacidad	Color	Embalaje
401055001	A	5.5L.	● Rojo	40
401055002	B	5.5L.	● Azul	40
401055003	C	5.5L.	● Negro	40
401055004	D	5.5L.	● Gris	40



A



B



N!



290x170x230mm

Bolsa térmica porta alimentos 9L.

Material: **poliéster y forro de PEVA**. Con **2 asas superiores** para llevar en la mano y una **cinta regulable acolchada** para llevarla colgada. Incluye **2 bolsillos exteriores**, uno con cremallera. Ideal para **mantener el calor o el frío** de los alimentos. Gran resistencia.

Referencia	Artículo	Capacidad	Color	Embalaje
401055005	A	9L.	● Negro	40
401055006	B	9L.	● Multicolor	40



C



D



N!



265x190x200mm

Bolsa térmica porta alimentos 8.5L.

Material: **poliéster y forro de PEVA**. Con un **asa superior** para llevar en la mano y una **cinta regulable acolchada** para llevarla colgada. Incluye **3 bolsillos exteriores**: uno frontal con cremallera y 2 laterales con rejilla. Ideal para **mantener el calor o el frío** de los alimentos. Gran resistencia.

Referencia	Artículo	Capacidad	Color	Embalaje
401055007	C	8.5L.	● Negro	32
401055008	D	8.5L.	● Negro con flores	32



A



B



C



D

Bolsa térmica porta alimentos

Tipo: rectangular. Material: PP.

Referencia	Artículo	Capacidad	Dimensión	Embalaje
002703154	A	5L.	220x180x165mm	40
002703155	B	10L.	280x180x280mm	30
002703129	C	15L.	300x200x250mm	40
002703156	D	20L.	300x240x340mm	30



Bolsa mochila térmica porta alimentos 14L.

 260x190x350mm

Material: **poliéster y forro de PEVA**. Con un **asa superior** para llevar en la mano y **2 asas acolchadas regulables** para llevarla en la espalda. Incluye **4 bolsillos exteriores**: 2 frontales, uno de ellos con cremallera y 2 laterales con rejilla. Ideal para **mantener el calor o el frío** de los alimentos. Gran resistencia.

Referencia	Capacidad	Color	Embalaje
401055009	14L.	● Gris	20





Nevera portátil 24L.

Material: **polipropileno**. Color: azul. Gran resistencia.

Referencia	Capacidad	Dimensión	Embalaje
002703114	24L.	400x300x360mm	2



Vaso medidor 600cc

Material: **PP. Graduada** Dimensión: Ø95x167mm.

Ideal para cuadrar medidas. Apto para **lavavajillas** 100°C y **microondas** (máx. 15min.). **Congelación** hasta -25°C. Pack 24 unidades.

Referencia	Capacidad	Embalaje
401050001	600cc.	120



Jarra medidora 500ml.

Graduada. Ideal para cuadrar medidas.

Referencia	Capacidad	Embalaje
002701773	500ml.	120



Jarra medidora 1L.



Graduada. Dimensión: Ø135x140mm. Ideal para cuadrar medidas. Apto para **lavavajillas** 100°C y **microondas** (máx. 15min.). **Congelación** hasta -25°C. Pack 12 unidades.

Referencia	Capacidad	Embalaje
401050000	1L.	96



Temporizador minutero de cocina

Apagado automático. Función **cuenta atrás**. División tiempo en 5 segundos. Material: **ABS**. Fácil, sencillo, cómodo y práctico.

Referencia	Tiempo	Dimensión	Embalaje
002703112	Hasta 60min.	Ø55x75mm	100



Temporizador minutero digital con imán de cocina

Temporizador **ultrafino** con **pantalla táctil**. Función **cuenta atrás y hacia delante**. Material: **ABS**. Con **alarma sonora** de finalización de tiempo. Utiliza 1 pila CR2025 (3V), incluida. Con **imán**. Fácil, sencillo, cómodo y práctico.

Referencia	Tiempo	Dimensión	Embalaje
401045003	Hasta 99min. 59seg.	60x11x93mm	300



Instrumentos de mesa

Menaje





Vaso liso de cristal

Fácil limpieza. Caja de 6 unidades. Apto para lavavajillas.

Referencia	Capacidad	Embalaje
002702586	320ml.	8



Set 8 vasos reutilizables 450ml.



Material: **PP**. Apto para lavavajillas 100°C y microondas. Congelación hasta -40°C. Pack 8 unidades.

Referencia	Capacidad	Color	Embalaje
401050002	450ml.	Verde / Azul / Rosa	12





Set 6 platos reutilizables Ø185mm

Material: **PP**. Apto para lavavajillas 100°C y microondas. Congelación hasta -40°C. Pack 6 unidades.

Referencia	Diámetro	Color	Embalaje
401045022	Ø185mm	Verde / Azul / Rosa	24



Jarra para agua 2L.

Material: **PP**. Tapa anti-olores y rejilla anticaída de cubitos. Apto para lavavajillas 100°C. Congelación hasta -40°C. Pack 4 unidades.

Referencia	Color	Embalaje
401030015	Verde	4
401030017	Azul	4
401030018	Rosa	4





Jarra para agua cuadrada

Material: **PP**. Diseño cuadrado para encajar perfectamente en la puerta del frigorífico.
Tapa protectora, asa ergonómica y **sistema antisalpicaduras**.
Apto para lavavajillas. Temperatura soportada -25°C ~ 100°C. Pack 6 unidades.

Referencia	Capacidad	Color	Embalaje
401030033	1.4L.	Azul	6
401030034	1.8L.	Azul	6



Set 6 pinzas de plástico cierra bolsas



Set 6 unidades: Colores surtidos.

Referencia	Embalaje
401045009	400



Bolsa 12 pinzas sujeta manteles



Color: blanco

Referencia	Material	Embalaje
401045008	PP	40



Ordenación y recipientes

Menaje





0.25L.

A



0.6L.

B



1L.

C



4.5L.

D



Táper hermético de plástico

Máxima hermeticidad. Material: PP.
Apto para microondas, congelador y lavavajillas.

Referencia	Artículo	Capacidad	Pack	Embalaje
401030000	A	0.25L.	3Ud.	24
401030001	B	0.6L.	3Ud.	24
401030002	C	1L.	3Ud.	24
401030004	D	4.5L.	1Ud.	24



Táper hermético de plástico



Tipo: **rectangular**. Material: plástico. **Libre de BPA**. Apto para microondas, congelador y lavavajillas.

Referencia	Artículo	Capacidad	Embalaje
401030012	A	380ml.	10
401030013	B	680ml.	8
401030014	C	1000ml.	8



Táper hermético de cristal

Tipo: **rectangular**. Material: cristal. **Libre de BPA**. Apto para microondas, congelador y lavavajillas.

Referencia	Artículo	Capacidad	Embalaje
002703105	A	400ml.	12
002703106	B	900ml.	8
002703107	C	1600ml.	6



Táper porta tortillas 2.2L.

Material: **PP**. Colores surtidos.
Dimensión: Ø225x85mm. Pack 12 unidades.

Referencia	Capacidad	Embalaje
401030006	2.2L.	48



Táper hermético

Material: **PP**. Color transparente. Apto para **microondas, lavavajillas y congelador**. Pack 12 unidades.

Referencia	Capacidad	Rejilla	Embalaje
401030029	2L.	Si	12
401030030	4L.	No	12



Contenedor reciclaje de aceite 1L.

Material: **PP**. **Con filtro e indicador de capacidad**. Utilizar con el aceite frío.
Dimensión: 175x135x140mm. Colores surtidos. Pack 12 unidades.

Referencia	Capacidad	Embalaje
401045004	1L.	72



Ordenación y recipientes Contenedores reciclaje



Bote de cocina apilable

Tipo: **rectangular**. Material: plástico. Tapa: **marrón**. Apto para microondas, congelador y lavavajillas. Pack 12 unidades.

Referencia	Artículo	Capacidad	Embalaje
401030021	A	0.8L.	12
401030022	B	1.2L.	12
401030023	C	1.9L.	12



Escurreplatos con bandeja

Material: **PP**. Con capacidad para platos hondos. Dimensión: 385x385x85mm. Pack 3 unidades.

Referencia	Color	Embalaje
401045019	Verde	3
401045020	Azul	3



Escurre cubiertos con bandeja

Tipo: rectangular. Material: **PP**.

Bandeja extraíble. Colores surtidos. Pack 12 unidades.

Referencia	Dimensión	Embalaje
401045005	180x85x120mm	24

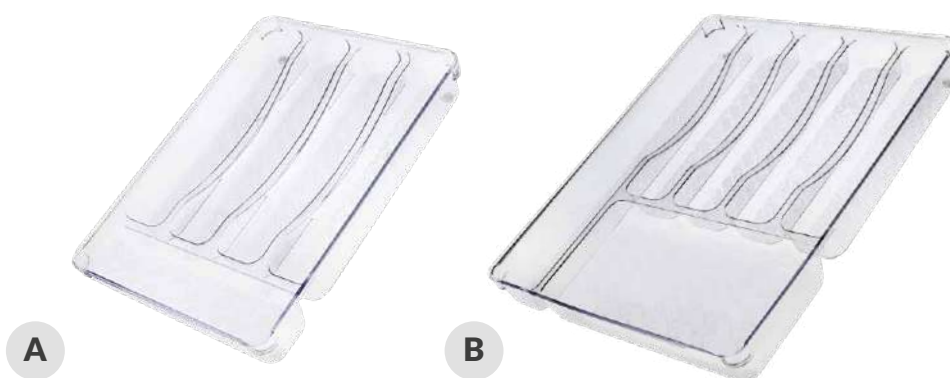

Cubertero antideslizante para cajón

Material: **SAN**. Color transparente.

Referencia	Artículo	Tipo	Dimensión	Embalaje
401030026	A	Pequeño	235x329x45mm	12
401030027	B	Grande	325x400x45mm	6

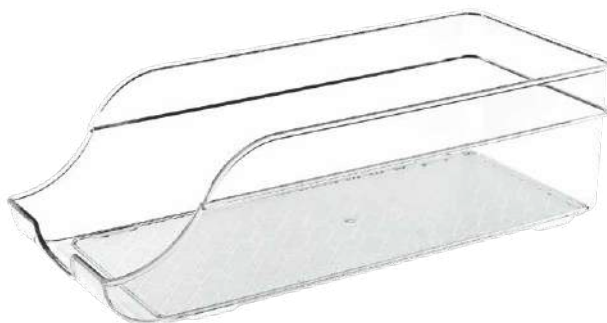

Organizador de frigorífico para latas

Material: **SAN**. Pack 6 unidades.

Referencia	Capacidad	Embalaje
401030024	Para 5 + 5 latas	6



Portarrollos papel cocina de bambú

Material: **bambú**. Cómodo, práctico y duradero.

Referencia	Dimensión	Embalaje
401045002	Ø145x320mm	96



Espátula para vitro

Cómoda, sencilla y práctica.

Referencia	Material	Embalaje
002701791	Acero inoxidable	12/144
002702556	Cuchilla recambio	



Esterilla antimoho

Corte **personalizado**. Recomendación de lavado: 30°C. Ideal **para neveras**.

Referencia	Dimensión	Embalaje
002703189	460x295mm	62





Hogar

Ferretería





A



B



C

Relojes de cocina

Marco de **aluminio**. Lente de **crystal**. Varillas de **aluminio**. Utiliza una pila AA, no incluida.

Referencia	Artículo	Tipo	Color marco	Color dial	Dimensión	Embalaje
405005000	A	Classic	● Níquel Satín	○ Blanco	Ø250x40mm	20
405005001	B	Classic	● Níquel Satín	● Negro	Ø254x45mm	20
405005008	C	Kuzine	● Níquel Satín	● Níquel Satín	Ø300x40.3mm	12



D



E

Relojes de cocina

Marco de **plástico**. Lente de **crystal**. Varillas de **aluminio**. Utiliza una pila AA, no incluida.

Referencia	Artículo	Tipo	Color marco	Color dial	Dimensión	Embalaje
405005002	D	Vintage	○ Blanco	○ Blanco	Ø334x67mm	6
405005003	E	Vintage	● Verde mint	○ Blanco	Ø334x67mm	6



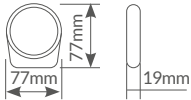

Reloj despertador analógico de bolsillo/sobremesa

Con **alarma**. Pila incluida. **Plegable**.

Referencia	Color	Pila	Embalaje
405005007	● Negro	1xLR44	200

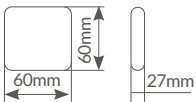

Reloj despertador sobremesa

Segundero **silencioso**. Con **alarma**. Función **snooze**. Pila no incluida.

Referencia	Color	Pila	Embalaje
002702535	● Negro	1xAA	100

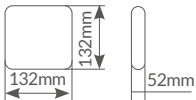

Reloj despertador de cuarzo sobremesa

Pilas no incluidas.

Referencia	Color	Pilas	Embalaje
405005006	● Negro	1 x AA	36

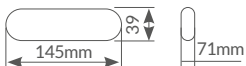

Reloj despertador digital

Con función **alarma y posponer**. Funciones: **termómetro, calendario**. Con **sensor táctil** para iluminar la pantalla. Pantalla digital **reversible**. Función **activar/desactivar el despertador girándolo**. Material: **ABS**. Pilas no incluidas.

Referencia	Color	Pilas	Embalaje
405005004	○ Blanco	2 x AAA	60
405005005	● Negro	2 x AAA	60

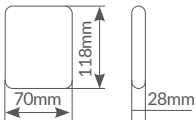

Radio vertical portátil

Sintonizador **AM** y **FM**. Con antena para mayor recepción. Con **conector para auriculares**. Ideal para usar en el baño o en la cocina. Funciona a pilas (no incluidas).

Referencia	Color	Pila	Embalaje
002402596	● Negro	2 x AA	90

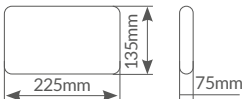

Radio horizontal portátil

Sintonizador **AM** y **FM**. Con **antena 360°** para una mayor recepción. Con **asa plegable**. Con **conector para auriculares**. Incluye cable de alimentación con clavija bipolar. Ideal para usar en la cocina. Funciona a **pilas y a corriente 230V**.

Referencia	Color	Pila	Embalaje
002402597	● Negro	2 x D / LR20	20

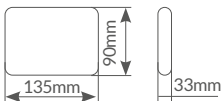

Radio digital portátil

Sintonizador **AM (520-1620KHz)** y **FM (87.5-108MHz)**.
 Con **conector para auriculares**. **Función alarma**. Función hora en formato **12/24h**. Con **memoria de hasta 30 emisoras**.
 Con **función DX**. Con **antena 360°** para una mayor recepción. Con **soporte desplegable** para que quede inclinada.
 Tacto suave. Decibelios: 77dB. Pantalla digital.

Referencia	Color	Pila	Embalaje
405010004	● Negro	2 x AAA	12

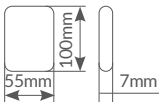

Calculadora bolsillo 8 dígitos

Funciona a **pilas** y **función solar**. Cálculo de **raíz cuadrada** y **porcentaje**. **Subdivisión en miles**.
 Memoria independiente. Con tapa rígida **abatible 360°**. Diseño compacto y elegante, ideal para utilizar en viajes.
 Pantalla LCD. Alimentación combinada solar/pilas. Teclas de goma suave. Pilas incluidas.

Referencia	Pila	Embalaje
002402598	1 x LR1130	200/400



Pipali

TENDEDERO

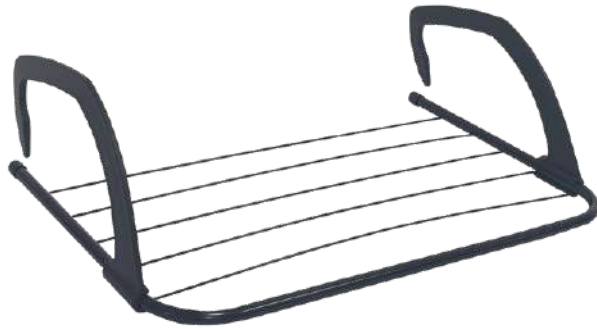

50x30x15.5cm

Tendedero plegable balcón radiador

6 barras de tendedero. Material: **acero** y PP. Fácil plegado. Ideal para colocar en balcones, barandillas, radiadores, ...

Referencia	Soporta hasta	Longitud tendido	Embalaje
402020013	3Kg.	3M	12

Bisalla

TENDEDERO

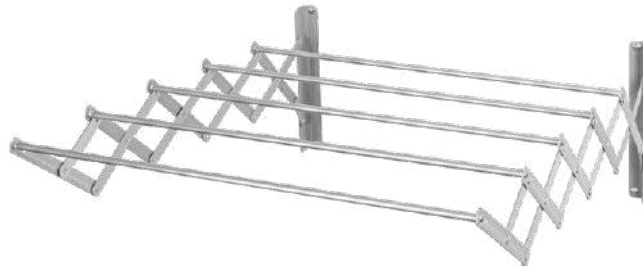
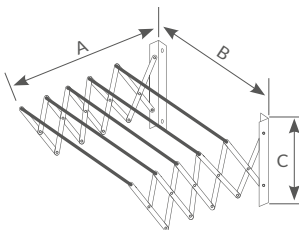

Tendedero extensible pared

5 barras de tendedero. Tipo: **acordeón**. Instalación en **pared**. Material: **aluminio**. Accesorios de instalación incluidos. Fácil plegado.

Referencia	Soporta hasta	Longitud tendido	Extensión (A)	Anchura (B)	Altura (C)	Embalaje
402020008	20Kg.	5M	1000mm	700mm	250mm	12
402020009	20Kg.	6M	1200mm	700mm	250mm	12
402020010	20Kg.	8M	1600mm	700mm	250mm	12

Chande

TENDEDERO



180x50x90cm

Tendedero plegable 2 alas acero pintado

Material: **acero** y PP. Con patas de goma para una mayor estabilidad. Fácil plegado.

Referencia	Soporta hasta	Longitud tendido	Altura máxima	Embalaje
402020011	16Kg.	16M	90cm	6

Manma

TENDEDERO



176x55x92cm

Tendedero plegable 2 alas aluminio

Material: **aluminio**, acero y PP. Con patas de goma para una mayor estabilidad. Fácil plegado.

Referencia	Soporta hasta	Longitud tendido	Altura máxima	Embalaje
402020012	18Kg.	18M	92cm	6



175x55x115cm

Tendedor plegable 2 alas resina

Tacos **antideslizantes**. Material: resina PP.
Estructura y cuerdas de tendido reforzadas. Fácil plegado.

Referencia	Soporta hasta	Longitud tendido	Altura máxima	Embalaje
002702538	20Kg.	20M	105cm	1

Elu

TABLA PLANCHAR



Tabla planchar

Material: rejilla de hierro. Gran estabilidad. **Funda algodón y poliéster.**
Soporte plancha con **4 puntos de silicona**. Bandeja de hierro ergonómica.
Tacos de goma. Diámetro tubo Ø21mm.

Referencia	Altura regulable	Superficie útil	Embalaje
400055002	650-890mm	1100x330mm	4

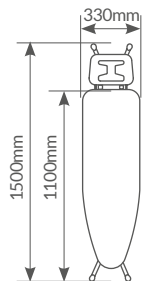

Opala

TABLA PLANCHAR



Tabla planchar

Material: rejilla de hierro. Gran estabilidad. **Funda algodón y poliéster.**
Soporte plancha con **4 puntos de silicona.** Bandeja de hierro ergonómica. Tacos de goma. **Taco regulable.** Diámetro tubo Ø25mm.

Referencia	Altura regulable	Superficie útil	Embalaje
400055003	670-890mm	1200x380mm	4

Skau

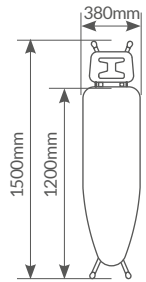
TABLA PLANCHAR



Tabla planchar

Material: rejilla de hierro. Gran estabilidad. **Funda 50% algodón, 50% poliéster.**
Soporte plancha con **6 puntos de silicona.** Bandeja de hierro ergonómica. Tacos de goma. Diámetro tubo Ø25-51mm.
Ideal para centro de planchado. Tabla de gran estabilidad gracias a sus patas de goma.

Referencia	Altura regulable	Niveles de altura	Superficie útil	Embalaje
400055009	Máx. 960mm	7	1250x450mm	2

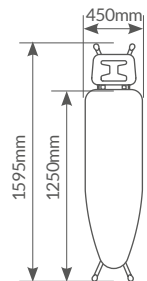

Funda tabla planchar S/M

Funda 100% algodón. Con espuma y muletón de 250gr. **Resiste altas temperaturas.** Apta para planchas de vapor. Fácil fijación.

Referencia	Para tablas	Embalaje
400055000	1200x350mm	1



Funda tabla planchar S/M

Funda 100% algodón. Con espuma y muletón. **Resiste altas temperaturas.** Apta para planchas de vapor. Fácil fijación.

Referencia	Para tablas	Embalaje
400055012	1200x350mm	30



Funda tabla planchar L/XL

Funda 100% algodón. Con espuma y muletón. **Resiste altas temperaturas.** Apta para planchas de vapor. Fácil fijación.

Referencia	Para tablas	Embalaje
400055013	1320x480mm	25



Cuerda de tender forrada

Material: **alma de acero.** Grosor: **Ø3mm.**

Referencia	Longitud	Color	Embalaje
002702540	20M	● Gris	40



Cuerda de tender cableada

Ideal para tendedores, campings.... Grosor: Ø5mm.

Referencia	Longitud	Color	Embalaje
002702542	15M	○ Blanco	30
002702544	25M	○ Blanco	50



Cuerda de sisal

Soporta hasta 20Kg.

Referencia	Artículo	Peso	Grosor	Longitud	Embalaje
402020001	A	600gr.	Ø8mm	15M lineales	25
402020002	A	750gr.	Ø10mm	15M lineales	25
002702546	B	200gr.	Ø2.5mm	48M lineales	40
002702547	C	500gr.	Ø3mm	100M lineales	20



Pinzas ropa de plástico

Pack 24 unidades.

Referencia	Material	Embalaje
002702548	Plástico	72

Pinzas ropa de plástico

Sujeción **antideslizante**. No deja marca. Pack 12 unidades.

Referencia	Material	Embalaje
402020016	Plástico	48



Pinzas ropa de madera

Pack 24 unidades.

Referencia	Material	Embalaje
002702549	Madera	60



Cesta porta pinzas con asa

Material: **PP**. Con cuelga fácil. Colores surtidos. Pack 12 unidades.

Referencia	Dimensión	Material	Embalaje
402020006	250x180x140mm	Plástico	60



Set 5 perchas de plástico

Material: plástico. Camisa con ranura/pantalón.

Referencia	Longitud	Embalaje
002702550	42cm	20





Set 6 perchas de madera

Material: madera. Camisa con ranura/pantalón. Diseño clásico.

Referencia	Longitud	Embalaje
002702551	42cm	24



Tijera de costura

Material: **acero inoxidable**. Tipo: niquelada.

Referencia	Tamaño	Embalaje
002703160	5" / 125mm	12/144
002703161	6" / 150mm	12/144



Tijera modista

Material: **acero inoxidable**. Tipo: niquelada.

Referencia	Tamaño	Embalaje
002703162	7" / 175mm	12/144



Tijera oficina

Material: mango **PP** y hoja **acero inoxidable**.

Referencia	Tamaño	Embalaje
002703165	215mm	12/144





Caja organizadora multiusos

Material: **plástico**.

Referencia	Color	Compartimentos	Embalaje
402030001	○ Transparente	7	12



Cajonera de almacenamiento 3 cajones

Material: **plástico**.

Referencia	Color	Compartimentos	Embalaje
402030002	● Negro/Transparente	3	6



Cesto organizador plástico

Material: **plástico**.

Referencia	Capacidad	Color	Embalaje
402030003	3.3L.	● Gris	6
402030004	5.2L.	● Gris	6
402030005	10L.	● Gris	6
402030006	14L.	● Gris	6
402030007	3.3L.	○ Blanco	6
402030008	5.2L.	○ Blanco	6
402030009	10L.	○ Blanco	6
402030010	14L.	○ Blanco	6



A



B



Cesto multiusos ovalado

Material: PVC.

Referencia	Artículo	Capacidad	Embalaje
402020014	A	24L.	1
402020015	B	37L.	1



A



B



Barreños plástico

Material: plástico.

Referencia	Artículo	Capacidad	Embalaje
402010003	A	5L.	24
402010004	B	7L.	24



Contenedor apilable con ruedas 36L.

Material: **PP**. Dimensión: 385x360x375mm.

Referencia	Capacidad	Embalaje
402030011	36L.	1



Cubo basura con pedal 7L.

Material: **PP**. Dimensión: 225x215x260mm. Pack 6 unidades.

Referencia	Capacidad	Embalaje
402005001	7L.	6



Cubo basura con pedal 10L.

Material: **PP. Cubeta extraíble.** Dimensión: 260x225x325mm. Pack 4 unidades.

Referencia	Capacidad	Embalaje
402005002	10L.	4



Cubo basura con pedal 22L.

Material: **PP.** Dimensión: 325x340x385mm

Referencia	Capacidad	Embalaje
402005000	22L.	4



Cubo basura modular de reciclaje 25L.

Material: **plástico**. Con **enganches** para poder añadir más módulos uno al lado del otro. Incluye **pegatinas de reciclaje**. Con **botón** para abrir la tapa. Compatible con bolsas de basura de tamaño estándar. Dimensión: 200x365x520mm.

Referencia	Capacidad	Embalaje
402005006	25L.	4



Cubo basura con pedal 26L.

Material: **plástico**. Dimensión: 300x290x450mm.

Referencia	Capacidad	Embalaje
402005004	26L.	1





Cubo basura con pedal y separador 52L.

Material: **plástico**. Dimensión: 420x375x500mm.

Referencia	Capacidad	Embalaje
402005005	52L.	1



Cubo basura con pedal 80L.

Material: **PP**. Con asa y ruedas. Dimensión: 500x400x650mm.

Referencia	Capacidad	Embalaje
402005003	80L.	1



A



B



Cubo de basura

Material: **plástico**. Tapa no incluida.

Referencia	Artículo	Capacidad	Embalaje
002703138	A	50L.	1
002703139	A	Tapa cubo basura 50L.	
402010007	A	Kit cubo de basura 50L con tapa	1
002703140	B	100L.	1
002703141	B	Tapa cubo basura 100L.	
402010008	B	Kit cubo de basura 100L con tapa	1

Hogar Capazos y cubos



Capazo negro 38L.

Material: **plástico**.

Referencia	Capacidad	Embalaje
002703142	38L.	12



Cubo redondo 7L.

Material: **plástico**.

Referencia	Capacidad	Embalaje
002703136	7L.	24



Set 5 bayetas microfibra

Ideal para atrapar el polvo. Pack 6 Unidades.

Referencia	Dimensión	Embalaje
002702552	380x440mm	6/24



Cubo redondo con escurridor 12L.



Material: **plástico**.

Referencia	Capacidad	Embalaje
402010001	12L.	12



Cepillo escoba recto

Material: cuerpo de **PP reciclado** y **fibras de PET**.

Colores surtidos: azul, verde, morado y gris.

Referencia	Tipo	Embalaje
402010010	Roscado	16



Cepillo escoba ovalado

Material: cuerpo de **plástico**.

Referencia	Tipo	Embalaje
002703159	Roscado	12





Cepillo escoba

Material: cuerpo de **plástico y fibra**.

Referencia	Tipo	Embalaje
402010000	Roscado	16



Cepillo escoba para exteriores

Material: cuerpo de **plástico y fibra**. Hebras **duras y resistentes**.

Referencia	Tipo	Embalaje
402010009	Roscado	16



Fregona de hilos finos

Material: cuerpo de **plástico**.

Referencia	Tipo	Embalaje
402010006	Roscado	30



Fregona tipo bayeta

Material: cuerpo de **plástico**.
Tiras bayeta muy absorbentes y ultra resistentes.

Referencia	Tipo	Embalaje
002703146	Roscado	20





Palo universal de titanio

Color: gris. Ergonómico.

Referencia	Longitud	Embalaje
002703147	1.4M	12

Hogar Desatascadores



Recogedor antivuelco con palo



Materiales: **plástico + TPE**. Mango de **acero + PP**.
Con goma para recoger mejor.

Referencia	Color	Embalaje
402010002	Negro / Azul	18



Desatascador fuelle grande



Material: **PVC/HDPE**.
Colores surtidos. Pack 12 unidades.

Referencia	Dimensión	Embalaje
402010005	Ø115x110mm	72



Desatascador manual

Material: **acero**. En bolsa.

Referencia	Longitud	Embalaje
003702417	5M	20

Desatascador neumático

Ideal para baños, lavabos, bañeras, fregaderos, etc. En bolsa.

Referencia	Embalaje
003702416	36



Papelera sobremesa 1.5L.

Material: **plástico**. Dimensión: Ø210x165mm.

Referencia	Capacidad	Embalaje
402005007	1.5L.	12





Escobillero gris

Material: **plástico**. Pack 16 Unidades.

Referencia	Color	Embalaje
404000003	Gris / Blanco	16



Cesto con percha multifunción

Material: **plástico**. Pack 12 Unidades.

Referencia	Color	Embalaje
404000004	Blanco	12



A



B



C

Alfombras de baño

Prácticas y cómodas.

Referencia	Artículo	Tipo/Material	Color	Dimensión	Embalaje
404000008	A	Antideslizante / PVC	● Azul	36x70cm	50
404000001	B	Microfibra 100% Poliéster	● Gris	40x60cm	30
404000002	C	Diatomita	● Azul	39x60cm	6



Barra extensible para cortina de ducha

Material: **aluminio**.

Referencia	Extensible	Embalaje
404000005	71-125cm	50
404000006	135-235cm	50



Cortina de ducha

Material: **100% poliéster**. Incluye 12 colgadores.

Referencia	Dimensión	Embalaje
404000007	180x180cm	50



Jardín y terraza

Ferretería





A



B



C



D



Hz

220-240V 50/60Hz

Mata insectos eléctricos

Amplia apertura para que **entren los mosquitos desde cualquier ángulo**.
Tubo **ultravioleta**. Bandeja extraíble. Cable: **1.2M**.

Referencia	Artículo	Potencia	Área cobertura	Carcasa	Dimensión	Embalaje
001605382	A	6W	80m ²	ABS	Ø120x300mm	20
001601246	A	Tubo repuesto 6W / 226mm				
001605383	B	2x10W	80m ²	ABS + Aluminio	437x100x265mm	5
001601247	B	Tubo repuesto 10W / 345mm				
001605384	C	2x15W	100m ²	ABS + Aluminio	542x100x265mm	4
001601248	C	Tubo repuesto 15W / 450mm				
001605385	D	2x20W	150m ²	ABS + Aluminio	696x100x265mm	4
001601291	D	Tubo repuesto 20W / 600mm				



Hz

230V

50Hz

Mata insectos eléctrico LED

Amplia apertura para que **entren los mosquitos desde cualquier ángulo**.
Tubo **LED ultravioleta**. Bandeja extraíble. Carcasa: ABS. Cable: **1.2M**. Instalación en **techo y pared**.

Referencia	Potencia	Área cobertura	Voltaje rejilla	Dimensión	Embalaje
105000000	11W	150m ²	4000V	330x100x263mm	6

Bamako

MATA INSECTOS



Hz

220-240V

50/60Hz

Mata insectos eléctrico Bamako

UVA-LED de alta calidad que logra una **mayor eficiencia** a la hora de capturar mosquitos.
Longitud de onda: 365nm. Material: ABS. Horas de vida: 20.000h. Bajo consumo.

Referencia	Potencia	Área cobertura	Voltaje mata insectos	Dimensión	Embalaje
105005000	1W	25m ²	800-1000V	100x70x105mm	100



IPX4 Uso exterior

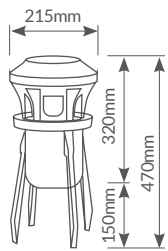

Para **aumentar al menos un 30% de atracción** se pueden colocar ingredientes atrayentes en el despósito, tales como: fruta, yogur, cerveza o agua con azúcar.

Mata insectos por absorción con ventilador

 IPX4  230V  50Hz

Material: ABS resistente al fuego. Cable: **1.2M**. Instalación: en suelo, sobremesa o colgado. Incluye asa para colgar.
Bombilla: 2U BLB 7W G24. Color negro. Bandeja extraíble. **Ecológico**, ya que no utiliza sustancias químicas, ni sprays.

Referencia	Potencia total	Área cobertura	Embalaje
105005002	9W	100m ²	4
105010002	Bombilla recambio mosquitero 7W		



6500K



E27



120°



20.000h.



Ø78x156mm

Lámpara LED mata antimosquitos

Longitud de onda: 395nm. Dos posiciones: **UV sólo** y **UV + luz fría**.
Voltaje rejilla: 2000V. **IK06**. 220-240V.

Referencia	Potencia	Lúmenes	Luz	Área cobertura	Embalaje
200660003	5W	380Lm	● 6500K	45m ²	40



6500K



120°



15.000



≥80Ra



30.000h.



Ø90x160mm

Lámpara LED USB mata mosquitos

Funciones: pila recargable 1800mAh. **Tiempo de carga:** 3.5h. Cable **USB 1M**.

Duración batería: Sólo luz: 7h. / Mata insectos: 6h. / Luz + mata insectos: 5h. Material **ABS + PP**.

Referencia	Potencia	Luz	Longitud de onda	Área cobertura	Embalaje
002005390	5W	● 6500K	365-395nm	40m ²	40





Mosquitera con velcro para ventanas

Con velcro. Fácil instalación. Color: negro.

Referencia	Dimensión	Material	Embalaje
402000004	130x150cm	100% Poliéster	80



Mosquitera magnética para puertas

Con imanes, velcro para los extremos y clavos para marcos de madera. Fácil instalación. Color: negro.

Referencia	Dimensión	Material	Embalaje
402000000	100x220cm	100% Poliéster	24

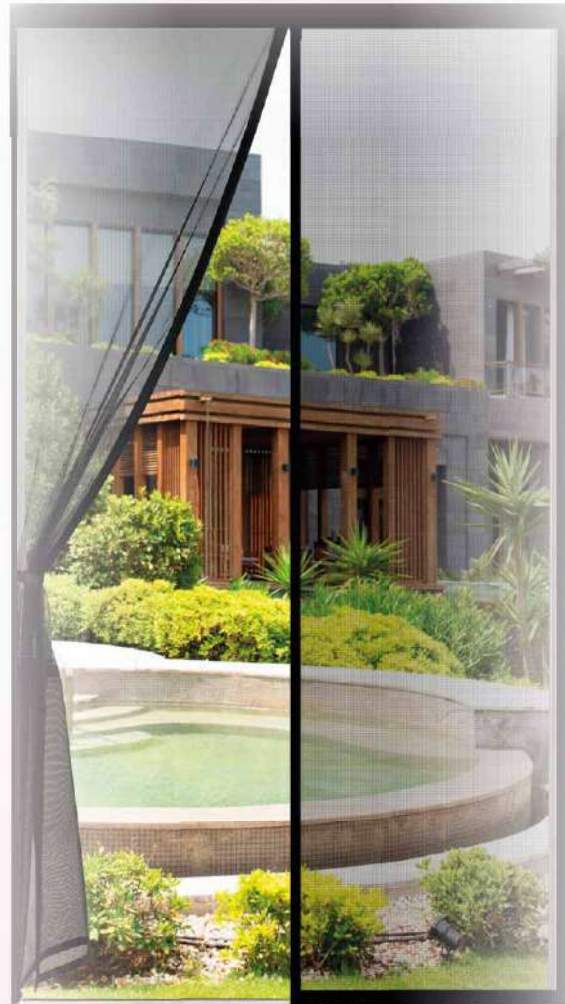

Jardín y terraza Mosquiteros



Mosquitera magnética para puertas

Con **imanes** interiores para un cierre perfecto, **velcro resistente y duradero** para los extremos y **clavos** para marcos de madera. Fácil instalación. Color: negro.

Referencia	Dimensión	Material	Embalaje
40200005	100x220cm	Fibra de vidrio	24



Mosquitera extensible para ventanas

Ajustable en anchura. Peso 0.5Kg. Material: **aluminio + fibra de vidrio**. Fácil instalación.

Referencia	Anchura	Altura	Color	Embalaje
402000001	Mín. 70cm ~ Máx. 132cm	Máx. 50cm	○ Blanco	10
402000003	Mín. 100cm ~ Máx. 192cm	Máx. 70cm	○ Blanco	10



Conector mangueras PVC

Material: **ABS**.

Referencia	Diámetro	Embalaje
003602028	Ø3/4"	24/240
003602029	Ø5/8"	24/240
003602070	Ø1/2"	24/240



Conector mangueras PVC con stop

Material: **ABS**. Conector rápido con **función stop**.

Referencia	Diámetro	Embalaje
003602030	Ø3/4"	24/240
003602031	Ø5/8"	24/240
003602071	Ø1/2"	24/240



Conector mangueras PVC con stop

Material: **ABS**. Conector rápido con **función stop**. Tipo: **hembra**.

Referencia	Diámetro	Embalaje
003602072	Ø3/4"	24/240



Reparador para mangueras PVC

Material: **ABS**. Conector rápido con **función stop**.

Referencia	Diámetro	Embalaje
003602032	Ø3/4"	24/240
003602033	Ø5/8" - Ø1/2"	24/240



Adaptador grifo hembra

Material: **ABS**. Para manguera PVC.

Referencia	Diámetro	Embalaje
003602034	Ø1"	24/240



Adaptador grifo hembra

Material: **ABS**. Para manguera PVC.

Referencia	Diámetro	Embalaje
003602035	Ø3/4" - Ø1/2"	24/240



Conector manguera PVC con válvula On/Off

Material: **ABS**.

Referencia	Diámetro	Embalaje
403000001	Ø1/2" - Ø3/8" - Ø5/8" - Ø3/4"	20/120





Conector manguera **espiral**

Material: **ABS**. Recambio para referencia 003602045.

Referencia	Diámetro	Embalaje
003602060	Ø3/8"	24/240

Conector **con brida**

Material: **ABS**. Para manguera PVC.

Referencia	Diámetro	Embalaje
003602073	Ø1/2" - 3/4"	24/120



Adaptador **grifo macho**

Material: **ABS**. Para manguera PVC.

Referencia	Diámetro	Embalaje
003602036	Ø3/4"	24/240

Conector **macho**

Material: **ABS**. Para manguera PVC.

Referencia	Embalaje
003602037	24/240



Derivación en Y

Material: **ABS**.

Referencia	Embalaje
003602038	24/240



Adaptador grifo 2 salidas

Material: **ABS**. Se puede cortar el agua por los 2 lados.

Referencia	Diámetro	Embalaje
003602039	Ø3/4"	12/120



Lanza regulable

Material: **ABS**. Para manguera PVC.

Referencia	Diámetro	Embalaje
003602040	Ø1/2"	24/216





Kit acople rápido con lanza

Material: **ABS + PP**. Para manguera PVC. El kit incluye: **lanza** para manguera PVC, **conector para manguera con stop** Ø5/8" (15mm), **conector para manguera** Ø5/8" (15mm), **adaptador grifo hembra** Ø1/2" (12.5mm) Ø3/4" (19mm).

Referencia	Embalaje
003602042	24/96



Pistola regulable

Material: **ABS + termoplástico**. Para manguera PVC.

Referencia	Diámetro	Embalaje
003602043	Ø1/2"	12/72



Pistola 7 funciones regulable

Material: **ABS + termoplástico**. Para manguera PVC.

Referencia	Díámetro	Embalaje
003602044	Ø1/2"	12/72



Enrolla manguera de pared

Material: **PP**.

Referencia	Embalaje
003602047	16/96





Aspersor giratorio 360°

Material: **PP**. Para manguera PVC.

Referencia	Embalaje
003602048	15/60



Aspersor riego por impacto

Material: **PP**. Tipo: **giratorio de 360°**. Para manguera PVC.

Referencia	Tipo	Embalaje
003602074	Base	50/100



Aspersor riego por impacto

Material: **PP**. Tipo: **giratorio de 360°**. Para manguera PVC.

Referencia	Tipo	Embalaje
003602075	Estaca	25/100



Kit manguera espiral

Incluye **pistola de 7 funciones**. Mango ergonómico. **Sistema aqua-stop**. Conector: Ø3/8". Blíster.

Referencia	Díámetro	Metros	Embalaje
003602027	Ø1/2"	7.5M	12
003602045	Ø1/2"	15M	8



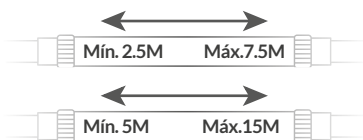

Kit manguera tipo serpiente

Incluye **pistola de 7 funciones** y **2 conectores rápidos**. Material exterior: hilo de **poliéster reforzado**. Material interior: **doble capa de látex**. Ideal para regar, lavar el coche, etc. **No se tuerce ni se enreda. Se expande automáticamente hasta 3 veces su tamaño** cuando hay agua. Cuando se corta el suministro la manguera se contrae rápidamente.

Referencia	Metros sin agua	Metros con agua	Embalaje
403010002	2.5M	7.5M	24
403010003	5M	15M	20

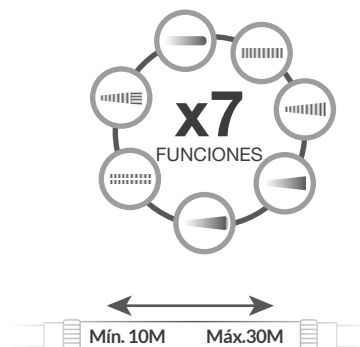

Kit manguera tipo serpiente + cesta con gancho

Incluye **pistola de 7 funciones** y **2 conectores rápidos**. Material exterior: hilo de **poliéster reforzado**. Material interior: **doble capa de látex**. Ideal para regar, lavar el coche, etc. **No se tuerce ni se enreda. Se expande automáticamente hasta 3 veces su tamaño** cuando hay agua. Cuando se corta el suministro la manguera se contrae rápidamente. **Expansión automática. Incluye cesta con gancho para colgar.**

Referencia	Metros sin agua	Metros con agua	Embalaje
403010000	10M	30M	6



Kit manguera trenzada PVC 10M para colgar en pared

Incluye **pistola de 7 funciones**. Incluye **cesta con gancho para colgar**.

Referencia	Diámetro	Metros	Embalaje
403010001	Ø1/2"	10M	6



Manguera trenzada PVC

De 3 capas. Presión: **7bar-20bar**. Material: **PVC + cordón textil tensado**. Ideal como manguera de riego. **Resistentes a la radiación ultravioleta**. Posee una capa que **impide la formación de algas**. Temperatura de trabajo: **-10°C + 50°C**. **Resistentes a la corrosión y abrasión**. Flexible. Retractilado.

Referencia	Diámetro	Metros	Embalaje
003602051	Ø5/8" (15mm)	15M	1
003602052	Ø5/8" (15mm)	25M	1
003602053	Ø3/4" (19mm)	25M	1



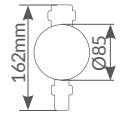

Temporizador de riego digital

Sistema de riego **manual** o **automático**. Con regulador de **tiempo** y **frecuencia**. Funciona con 2 pilas AAA (no incluidas). Función **delay** (cuando llueve se desactiva). Rosca entrada: 1" - 3/4" - 1/2". Rosca salida: 3/4". **IPX3**.

Referencia	Frecuencia riego	Duración riego	Embalaje
403025006	1-72h.	1-120min.	20

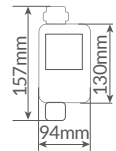

Temporizador de riego digital

Sistema de riego **manual** o **automático**. Con regulador de **tiempo** y **frecuencia**. Funciona con 2 pilas AA (no incluidas). Pantalla **LCD**. Función **delay** (cuando llueve se desactiva). Rosca entrada: 1"-3/4" - 1/2". Rosca salida: 3/4". **IPX3**.

Referencia	Frecuencia riego	Duración riego	Embalaje
403025005	1-23h. / 1-30 días	1-599min. / 1-24h.	20



Sistema de riego por goteo automático

Sistema de riego **manual** o **automático**. Con regulador de **tiempo y frecuencia**.

El kit incluye: 1 temporizador, 1 conector grifo, 1 conector rápido, 1 tubo (15M), 10 clavijas de pared, 30 conexiones en "T", 10 conexiones rectas, 20 estacas de apoyo, 10 pulverizadores, 10 de goteo, 10 de aspersión y 10 accesorios de riego.

3 sistemas de riego: aspersión, goteo y pulverización. Indicador luminoso. Funciona con 3 pilas AAA (no incluidas).

Rosca entrada: 1"-3/4" - 1/2". Rosca salida: 3/4". **IP54**.

Referencia	Frecuencia riego	Duración riego	Embalaje
403025002	1/2/3/4h...1 semana	1/2/3/5...hasta 55min.	16



Bomba de riego por goteo

Con regulador de **tiempo y frecuencia**. Función **manual o automático**.

Incluye: 1 bomba de agua, 1 tubo, 3 tapas tubo, 1 filtro, 10 conectores, 3 conexiones en "X", 10 conexiones en "T", 3 conexiones rectas. Funciona con **4 pilas AA** o **cable USB** (no incluidos). **Función delay** (se apaga si llueve). **Válvula solenoide**. Posición multifunción. **Alerta escasez de agua**. Con gancho para colgar. Sin conexión de grifo. Uso interior.

Referencia	Duración riego	Duración riego	Embalaje
403025003	1-6 seg a 1-30min.	1-23h. hasta 2-7 días	16



Pluviómetro con estaca

Altura: 44cm. 1 trazo = 1ml = 1L/m². Mide hasta 35l/m².

Referencia	Capacidad	Con	Embalaje
502065003	175ml.	Estaca	5/20



Tijera de poda a una mano

Material: **acero de carbono forjado**. Mango **antideslizante**. Blíster.

Referencia	Hoja	Embalaje
003602056	60mm	6/60



Tijera de poda a una mano

Material: mango **PVC + aluminio**. Hoja de **acero**.
Diámetro corte: Ø150mm. Corte **bypass**. Blíster.

Referencia	Hoja	Embalaje
403015010	57mm	48





Tijera de poda a una mano

Material: mango **PVC + aluminio**. Hoja de **acero**.
Sistema de bloqueo. Diámetro corte: Ø150mm. Corte **bypass**. Blíster.

Referencia	Hoja	Embalaje
403015011	55mm	100



Tijera de poda a una mano

Material: mango **ABS + TPR**. Hoja de **acero**.
Sistema de bloqueo. Diámetro corte: Ø150mm.
 Corte **yunque**. Blíster.

Referencia	Hoja	Embalaje
403015012	50mm	24



Tijera poda corte bypass

Color: naranja / verde. Hoja de **acero**.

Referencia	Hoja	Embalaje
403015009	90mm	60



Cortasetos fijo

Color: naranja / verde. Hoja de **acero**.

Referencia	Hoja	Embalaje
403015008	190mm	24



Cortasetos telescópico

Color: naranja / verde. Hoja de **acero**.

Referencia	Hoja	Embalaje
403015007	200mm	10



Sierra de mano 450mm

Material: mango **ABS + TPR**. Hoja de **acero triple bisel**.
Corte **bypass**. Para madera y ramas secas.

Referencia	Hoja	Embalaje
403015013	450mm	12





Sierra de arco

Hoja de **acero**.
Para madera y ramas secas.

Referencia	Hoja	Embalaje
403015014	540mm	60



Serrucho de hoja recta

Material: mango **ABS + TPR**.
Hoja de **acero triple bisel**. Para madera y ramas.

Referencia	Hoja	Embalaje
403015015	330mm	48



Serrucho de hoja curva

Material: mango **ABS + TPR**.
Hoja de **acero triple bisel**. Para madera y ramas.

Referencia	Hoja	Embalaje
403015016	330mm	50



Serrucho con hoja plegable

Material: mango **ABS + TPR**.
Hoja de **acero**. Para madera y ramas.

Referencia	Hoja	Embalaje
403015017	160mm	48



Serrucho de doble diente con hoja

Material: mango **ABS + Acero**. Orificio para colocar un palo de 25mm.
Hoja de **acero doble bisel**. Con doble diente. Para madera y ramas.

Referencia	Hoja	Embalaje
403015018	315mm	24



Pala de jardinería

Mango: **ABS + TPR**. Hoja: **acero de carbono** 75mm.

Referencia	Pala	Embalaje
403015020	325mm	24

Pala de jardinería

Mango: **ABS + TPR**. Hoja: **acero de carbono** 50mm.

Referencia	Longitud	Embalaje
403015019	325mm	24



Azada + rastrillo jardinería

Mango: **ABS + TPR**. Hoja: **acero de carbono** 185mm.

Referencia	Longitud	Embalaje
403015021	260mm	24

Escoba de 22 púas de acero

Mango: **acero**. Para palo universal.
Diámetro agujero para colocar el palo: de 24mm a 28mm

Referencia	Anchura	Embalaje
403015022	380mm	12



Pulverizador doméstico 1L.

Material: **plástico**. Tipo: **pistola**.

Referencia	Capacidad	Embalaje
003602057	1L.	100



Pulverizador a presión 2L.

Material: **plástico**. Tipo: **pistola**.

Referencia	Capacidad	Embalaje
003602058	2L.	20



Pulverizador a presión 5L.

Material: **plástico**. Tipo: **lanza**.
Con asa y cinturón. Peso en vacío: 1.15Kg.

Referencia	Capacidad	Embalaje
003602064	5L.	6



Pulverizador a presión mochila 12L.

Material: **plástico**. Tipo: **lanza**.
Con asa y cinturón. Peso en vacío: 2.40Kg.

Referencia	Capacidad	Embalaje
403015000	12L.	1





Pomara

MACETAS



Jardín y terraza Macetas



Macetas blancas y negras

Material: **PP**. Forma: redonda.

Referencia	Diámetro	Altura	Volumen recipiente	Color	Embalaje
403030001	Ø130mm	115mm	1L.	○ Blanco	24
403030002	Ø150mm	132mm	1.7L.	○ Blanco	24
403030003	Ø180mm	160mm	3L.	○ Blanco	18
403030004	Ø250mm	223mm	8L.	○ Blanco	9
403030005	Ø300mm	268mm	13.5L.	○ Blanco	6
403030010	Ø130mm	115mm	1L.	● Gris antracita	24
403030011	Ø150mm	132mm	1.7L.	● Gris antracita	24
403030012	Ø180mm	160mm	3L.	● Gris antracita	18
403030013	Ø250mm	223mm	8L.	● Gris antracita	9
403030014	Ø300mm	268mm	13.5L.	● Gris antracita	6

Kilan MACETAS



Macetas blanca y negra

Material: **PP**. Forma: redonda. Tipo: paraguas.

Referencia	Diámetro	Altura	Volumen recipiente	Color	Embalaje
403030006	Ø300mm	500mm	23.5L.	○ Blanco	6
403030015	Ø300mm	500mm	23.5L.	● Gris antracita	6



Plato para macetas

Material: **PP**. Forma: redonda.

Referencia	Diámetro	Altura	Color	Embalaje
403030007	Ø150mm	25mm	○ Blanco	24
403030008	Ø200mm	25mm	○ Blanco	18
403030009	Ø305mm	25mm	○ Blanco	12
403030016	Ø150mm	25mm	● Gris antracita	24
403030017	Ø200mm	25mm	● Gris antracita	18
403030018	Ø305mm	25mm	● Gris antracita	12



Termómetros analógicos

Uso interior y exterior.

Referencia	Artículo	Medida	Dimensión	Material	Embalaje
502065000	A	Celsius / Fahrenheit	43x200mm	Plástico	50/200
502065002	B	Celsius	34x200mm	Madera	30/120
502065001	C	Celsius	60x260mm	Plástico	50/100



Mesa plegable polietileno

Grosor tablero: 45mm. **Grosor mesa plegada:** 90mm. **Tubo:** Ø25mm. **Peso máximo soportado:** 150Kg.
Material: polietileno HDPE y patas de acero. Cómoda y manejable. **Con asa** para transporte.

Referencia	Capacidad	Dimensión abierta	Dimensión cerrada	Cierre seguridad	Embalaje
003602096	6 personas	1520x760x745mm	780x760x90mm	-	1
003602097	8 personas	1805x740x740mm	936x740x90mm	Sí	1



Banco plegable polietileno

Grosor tablero: 40mm. **Grosor banco plegado:** 80mm. **Tubo:** Ø22mm. **Peso máximo soportado:** 300Kg.
Material: polietileno HDPE y patas de acero. Cómodo y manejable. **Con asa** para transporte.

Referencia	Capacidad	Dimensión abierta	Dimensión cerrada	Cierre seguridad	Embalaje
003602099	4 personas	1840x280x430mm	940x280x80mm	Sí	1





Fontanería

Ferretería





Alcachofa ducha eco ahorro simple

Material: **ABS**. Color: **blanco**. **Sistema eco ahorro:** con adaptador para ahorrar hasta un 40% de agua. En bolsa.

Referencia	Diámetro	Eco ahorro	Embalaje
404005000	Ø73mm	30-40%	20



Alcachofa ducha eco ahorro simple

Material: **ABS**. Color: **cromado brillo**. **Sistema eco ahorro:** con adaptador para ahorrar hasta un 40% de agua. Consumo máximo de agua: **10bars**. En bolsa.

Referencia	Diámetro	Eco ahorro	Embalaje
404005001	Ø73mm	30-40%	20



Alcachofa ducha eco ahorro simple

Material: **ABS**. Color: **cromado brillo**. **Sistema eco ahorro:** con adaptador para ahorrar hasta un 40% de agua. En bolsa.

Referencia	Diámetro	Eco ahorro	Embalaje
404005002	Ø100mm	30-40%	20



Alcachofa ducha eco ahorro 3 funciones

Material: **ABS**. Color: **cromado brillo**. 3 funciones: **caudal máximo, medio y modo masaje**. **Sistema eco ahorro:** con adaptador para ahorrar hasta un 40% de agua. En bolsa.

Referencia	Diámetro	Eco ahorro	Embalaje
404005003	Ø100mm	30-40%	20



Kit ducha eco ahorro 3 funciones

Incluye: **alcachofa 3 funciones + flexo (1.5M) + soporte ajustable.** Material: **ABS.** Color: **cromado brillo.**

Sistema eco ahorro: con adaptador para ahorrar hasta un 40% de agua.

3 funciones: **caudal máximo, medio y modo masaje.**

Consumo máximo de agua: **10bars.** En bolsa.

Referencia	Diámetro	Eco ahorro	Embalaje
404005004	Ø129mm	30-40%	20



Flexo ducha cromado

Material: **acero inoxidable cromado.**

Enganche doble. Extensible en longitud. **Tuercas de latón.**

Alta resistencia. **Doble engatillado extensible.** En bolsa.

Referencia	Longitud	Dimensión	Embalaje
003702404	1.5M	Ø13x1500mm	50



Flexo ducha cromado extensible

Material: **acero inoxidable** cromado.

Enganche doble. Extensible en longitud. **Tuercas de latón.**

Alta resistencia. **Doble engatillado extensible.** En bolsa.

Referencia	Longitud	Dimensión	Embalaje
003702429	1.75-2.25M	Ø13x2250mm	100



Flexo ducha PVC

Material: **PVC.** **Tuercas de latón.**

Alta resistencia a la flexión, tracción y aplastamiento. En bolsa.

Referencia	Longitud	Dimensión	Embalaje
003702403	1.5M	Ø13x1500mm	50





Barra de agarre sujeción

Material: **latón cromado**

Referencia	Dimensión	Embalaje
003702427	Ø25x300mm	20
003702428	Ø25x400mm	20



Soporte de ducha PVC

Material: **ABS**. Color: **cromado brillo**. En bolsa.

Referencia	Dimensión	Embalaje
404000000	40x70x57mm	50



Hembra



Macho

Atomizador hembra / macho

Para grifo. Pack 10 unidades.

Referencia	Tipo	Dimensión	Embalaje
003702406	Hembra	Ø22/100	10/50
003702407	Macho	Ø24/100	10/50



Atomizador universal

Material: **ABS**. Para grifo. Conector: macho/hembra.

Referencia	Diámetro	Dimensión	Embalaje
404030000	Ø24M/Ø22H	Ø35x61mm	1/100





Tapa universal WC

Material: **PP. Cierre progresivo.** Fácil de montar. **Especial anticorrosión.** Incluye tuerca intermedia.

Referencia	Dimensión	Embalaje
003703186	370x465mm	1
003703185	Recambio anclajes tapa WC Ref. 003703186	

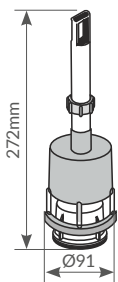

Descargador inodoro tipo tirador

Adaptable al sistema tradicional, ya que incluye base de recambio tradicional de rosca. Tubo rebosadero **regulable en altura.** Goma cierre de caucho.

Referencia	Descarga	Incluye	Embalaje
404010004	Simple	Base + Juntas	14

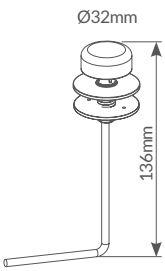

Tirador cisterna para descargador

Tirador **ABS cromado** con varilla metálica en ángulo.

Referencia	Para	Embalaje
404010010	404010004	25

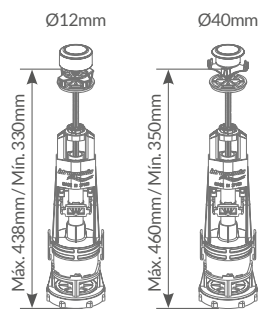

Descargador inodoro con pulsador interrumpible

Adaptable al sistema tradicional, ya que incluye base de recambio tradicional de rosca. Pulsador **ajustable en altura**. Tubo rebosadero. Diámetro mínimo tapa de la cisterna de Ø12mm. Goma cierre de caucho. Descargador universal **para todos los modelos de cerámica**. Instalación sin necesidad de herramientas. **Sin necesidad de desmontar cisterna**.

Referencia	Descarga	Incluye	Embalaje
404010002	Interrumpible	Base + Juntas	35

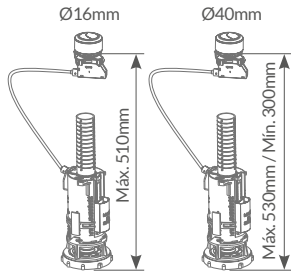

Descargador inodoro con doble pulsador regulable

Adaptable al sistema tradicional, ya que incluye base de recambio tradicional de rosca.

Regulación residual. Regulación descarga parcial. Tubo rebosadero.

El pulsador se puede colocar indistintamente en la **parte superior, lateral o frontal de la cisterna.**

Cubriendo así, todas las excentricidades de las cisternas.

Goma cierre de caucho. Descargador universal **para todos los modelos de cerámica.**

Instalación sin necesidad de herramientas. **Sin necesidad de desmontar cisterna.**

Referencia	Descarga	Incluye	Embalaje
404010003	Doble pulsador con cable	Base + Juntas	35



Mecanismo con pulsador doble universal

Ahorro de agua, doble descarga. Ajuste automático de altura. Descarga rápida de agua.

Instalación sin masilla. Regulación de la descarga. Muy fácil de instalar. Apto para todo tipo de aguas.

Referencia	Incluye	Embalaje
404010000	Base + Descargador + Juntas	20

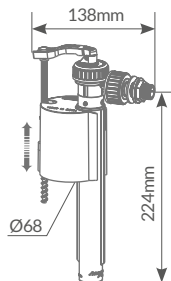

Flotador lateral compacto universal

Cierre por pistón. Sistema anti-retorno. Filtro de agua incorporado.
Boya regulable en altura. Apto para todo tipo de agua.
Presión de trabajo: 0.5-10bar. Resiste picos de presión hasta 12bar.
 Compatible con todas las cisternas cerámicas. Rápida instalación.

Referencia	Conexión	Alimentación	Embalaje
404010005	3/8" Latón	Lateral	35

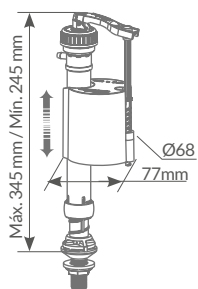

Flotador inferior compacto universal

Cierre por pistón. Sistema anti-retorno. Filtro de agua incorporado.
Boya regulable en altura. **Telecópico** regulable en altura. Apto para todo tipo de agua.
Presión de trabajo: 0.5-10bar. Resiste picos de presión hasta 12bar.
 Compatible con todas las cisternas cerámicas. Rápida instalación.

Referencia	Conexión	Alimentación	Embalaje
404010006	3/8" Latón	Inferior	40

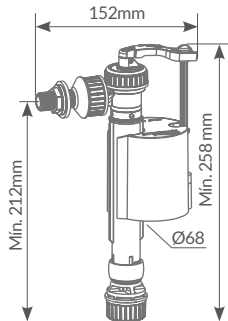

Flotador doble compacto universal

Cierre por pistón. Sistema anti-retorno. Filtro de agua incorporado.
Boya regulable en altura. **Telecópico** regulable en altura. Apto para todo tipo de agua.
Presión de trabajo: 0.5-10bar. Resiste picos de presión hasta 12bar.
 Compatible con todas las cisternas cerámicas. Rápida instalación.

Referencia	Conexión	Alimentación	Embalaje
404010007	3/8" Plástico	Lateral ó Inferior	35

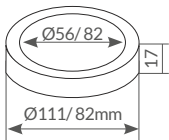

Kit juntas acoplamiento



Tipo: universal.
 Material: **goma espuma**.

Referencia	Bolsa	Embalaje
404010008	2 Ud.	50

Tornillos fijación cisterna tanque bajo



Tipo: universal para cisternas de tanque bajo. Material: **hierro + goma**. Especial anticorrosión. Incluye **tuerca intermedia**.
 Bolsa 2 unid.

Referencia	Dimensión	Embalaje
404010009	M6 x 90mm	200

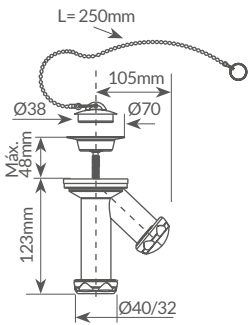

Sifón "Y" compacto con válvula lavabo-bidet

Con junta cónica reductora de Ø32mm.

Referencia	Salida	Rosca entrada	Diámetro salida	Embalaje
404035000	Tipo Y	Ø70mm	Ø40/32mm	60

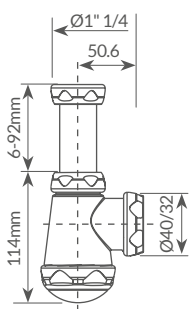

Sifón botella corto extensible

Con junta cónica reductora de Ø32mm.

Referencia	Salida	Rosca entrada	Diámetro salida	Embalaje
404035001	Horizontal	Ø1" 1/4	Ø40/32mm	80

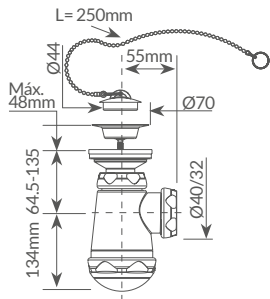

Sifón botella extensible lavabo-bidet

Con **junta cónica** reductora de Ø32mm.

Referencia	Salida	Rosca entrada	Diámetro salida	Embalaje
404035003	Horizontal	Ø1" 1/2 / Ø70mm	Ø40/32mm	45

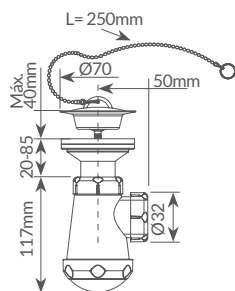

Sifón botella corto extensible lavabo-bidet

Con **junta cónica** reductora de Ø32mm.

Referencia	Salida	Rosca entrada	Diámetro salida	Embalaje
404035002	Horizontal	Ø1" 1/4 / Ø70mm	Ø/32mm	65



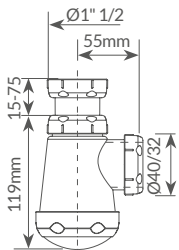

Sifón botella extensible fregadero

Con **junta cónica** reductora de Ø32mm.

Referencia	Salida	Rosca entrada	Diámetro salida	Embalaje
404035004	Horizontal	Ø1" 1/2	Ø40/32mm	65

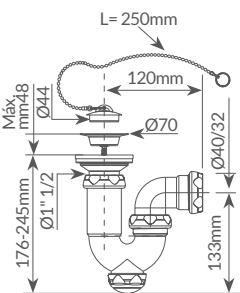

Sifón curvo extensible lavabo-bidet

Con **junta cónica** reductora de Ø32mm. **Válvula lavabo-bidet**

Referencia	Salida	Rosca entrada	Diámetro salida	Embalaje
404035005	Horizontal	Ø1" 1/2 / Ø70mm	Ø40/32mm	40

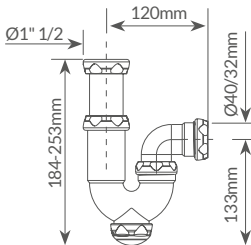

Sifón curvo extensible fregadero

Con **junta cónica** reductora de Ø32mm.

Referencia	Salida	Rosca entrada	Diámetro salida	Embalaje
404035006	Horizontal	Ø1" 1/2	Ø40/32mm	40

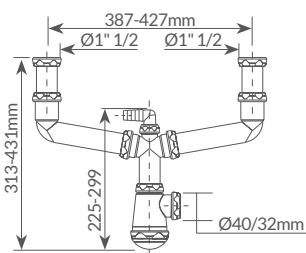

Sifón doble para fregadero s/v

Con **junta cónica** reductora de Ø32mm. Con **doble racor extensible** y toma auxiliar.

Referencia	Salida	Válvula	Diámetro entrada	Diámetro salida	Embalaje
404035007	Horizontal	No	Ø1" 1/2	Ø40/32mm	15

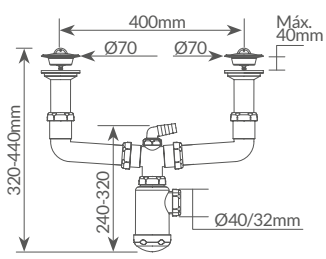

Sifón doble para fregadero c/v

Con junta cónica reductora de Ø32mm. Con doble válvula fregadero y toma auxiliar.

Referencia	Salida	Válvula	Diámetro entrada	Diámetro salida	Embalaje
404035008	Horizontal	Si	Ø70mm	Ø40/32mm	12

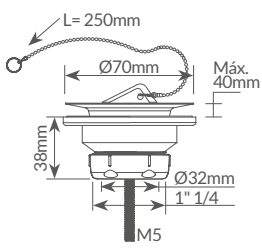

Válvula lavabo-bidet

Para lavabo-bidet.

Referencia	Rosca	Diámetro	Embalaje
404035013	1" 1/4	Ø70mm	75

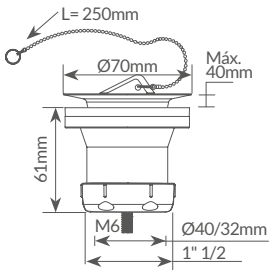

Válvula lavabo-bidet

Para lavabo-bidet.

Referencia	Rosca	Diámetro	Embalaje
404035014	1" 1/2	Ø70mm	75

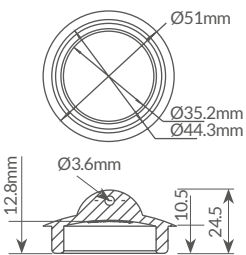

Tapón cónico para válvula

Tipo: cónico. **Universal.**

Referencia	Diámetro	Embalaje
404035021	Ø42-52mm	25

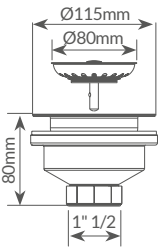

Válvula fregadero con cesta

Material: **acero inoxidable**. Con tornillo para instalación en **fregaderos inoxidables y sintéticos**.

Referencia	Diámetro	Rosca	Embalaje
404035012	Ø115mm	1" 1/2	25

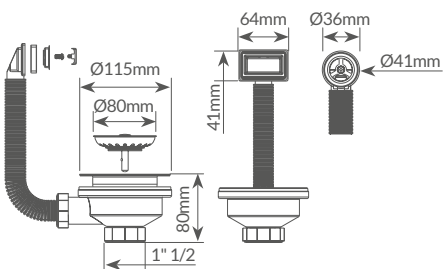

Válvula fregadero con cesta y rebosadero

Material: **acero inoxidable**. Con 2 rebosaderos flexibles: rectangular y redondo.
Con tornillo para instalación en **fregaderos inoxidables y sintéticos**.

Referencia	Nº rebosaderos	Diámetro	Rosca	Embalaje
404035011	2	Ø115mm	1" 1/2	25

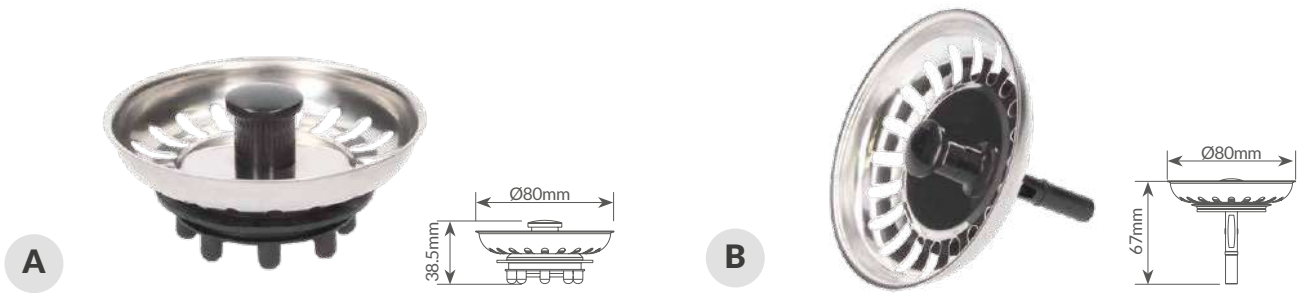

Rejilla filtro fregadero

Material: **acero inoxidable**. Para válvula cesta de Ø80mm.

Referencia	Artículo	Tipo	Embalaje
404035017	A	Araña	200
404035018	B	Con pasador	200

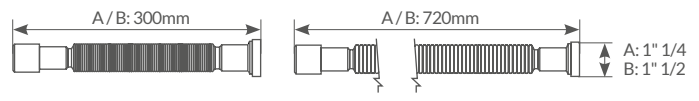

Tubo flexible

Longitud **máxima**: 720mm. Longitud **mínima**: 300mm. Color: blanco.

Referencia	Artículo	Para	Rosca	Diámetro	Embalaje
404035009	C	Lavabo-bidet	1" 1/4	Ø32-40mm	50
404035010	D	Fregadero	1" 1/2	Ø40-50mm	50

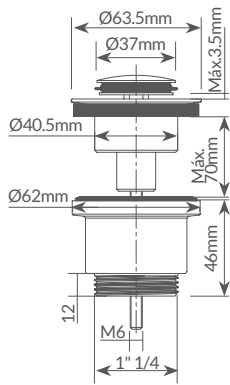

Válvula desagüe lavabo clic-clac Ø37mm

Material: **latón cromado + muelle inoxidable. Sistema clic-clac anti calcáreo.**
 Junta de cierre NBR90° de alta calidad. **Universal** para lavabos con y sin rebosadero.

Referencia	Tapón interior	Rosca	Embalaje
404035019	Ø37mm	1" 1/2	50

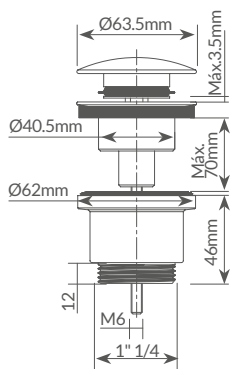

Válvula desagüe lavabo clic-clac Ø63mm

Material: **latón cromado + muelle inoxidable. Sistema clic-clac anti calcáreo.**
 Junta de cierre NBR90° de alta calidad. **Universal** para lavabos con y sin rebosadero.

Referencia	Tapón interior	Rosca	Embalaje
404035020	Ø63mm	1" 1/4	50





Cadena para tapón con 2 anillas

Cromado.

Referencia	Longitud	Embalaje
404035022	250mm	25
404035023	380mm	25

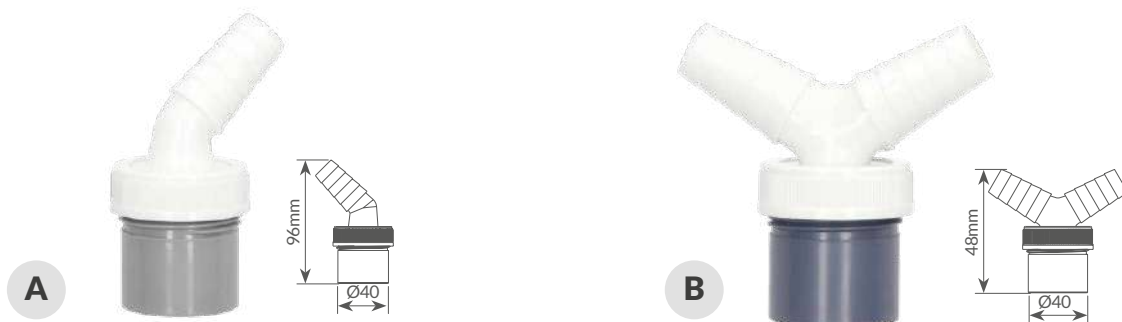

Conexión PVC para electrodomésticos

Material: **PVC**. Conexión para encolar.

Referencia	Artículo	Nº de tomas	Diámetro	Embalaje
404035015	A	1	Ø40mm	150
404035016	B	2	Ø40mm	150



Niágara

SERIE



A Lavabo

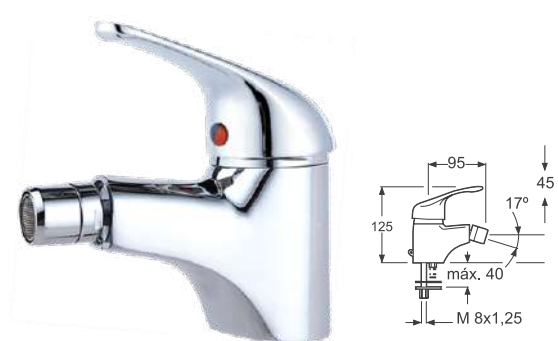

B Bidet

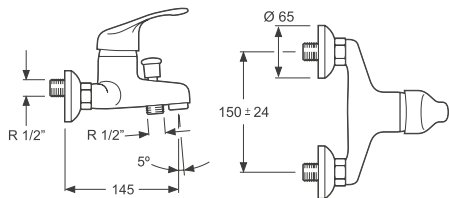

C Baño

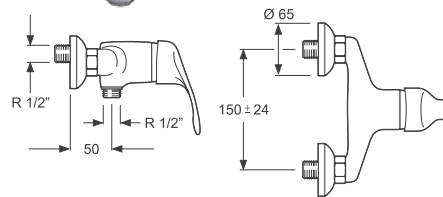

D Ducha

Monomandos Serie Niágara

Acabado cromado. Cartucho de discos cerámicos 40mm. Color: níquel satín.

Referencia	Artículo	Tipo	Diámetro	Conexión	Embalaje
003702408	A	Lavabo	Ø40mm	Latiguillo 3/8" - 360mm	15
003702409	B	Bidet	Ø40mm	Latiguillo 3/8" - 360mm	15
003702410	C	Baño	Ø40mm	Flexo 1/2"	12
003702411	D	Ducha	Ø40mm	Flexo 1/2"	10

Niágara

SERIE

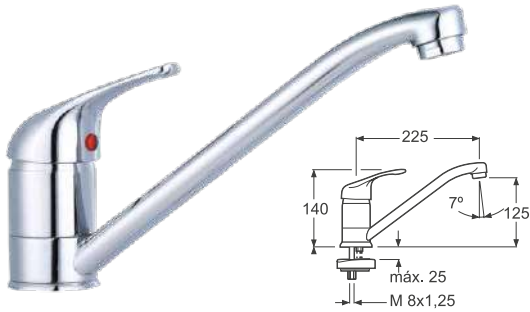

A Caño tubo



B Semicurvado



C Curvado



D Curvado 90°

Monomandos fregadero Serie Niágara

Acabado cromado. Cartucho de discos cerámicos 40mm. Color: níquel satín.

Caño fundido giratorio. Latiguillos incluidos, menos en la referencia 003702415. Con bolsa acolchada para protegerlos.

Referencia	Artículo	Tipo	Diámetro	Conexión	Embalaje
003702412	A	Caño tubo	Ø40mm	Latiguillo 3/8" - 360mm	15
003702413	B	Semicurvado	Ø40mm	Latiguillo 3/8" - 360mm	10
003702414	C	Curvado	Ø40mm	Latiguillo 3/8" - 360mm	10
003702415	D	Curvado 90°	Ø40mm	Flexo 1/2"	10



Iguazú

SERIE

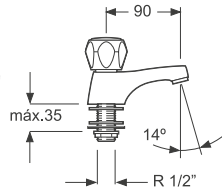

A Lavabo

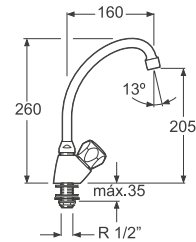

B Semicurvado

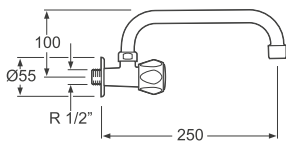

C Pared 180°

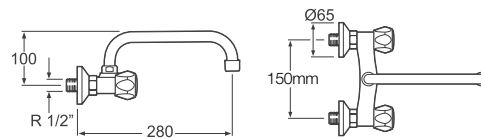

D 2 mandos pared

Grifos Serie Iguazú

Acabado cromado. Cartucho de discos cerámicos 40mm. Color: níquel satín.
Caño fundido giratorio, menos la referencia 003702420. Con bolsa acolchada para protegerlos.

Referencia	Artículo	Tipo	Diámetro	Conexión	Embalaje
003702420	A	Lavabo	Ø40mm	Latiguillo 3/8" - 360mm	20
003702421	B	Semicurvado de repisa	Ø40mm	Latiguillo 3/8" - 360mm	10
003702422	C	Pared 180°	Ø40mm	Flexo 1/2"	20
003702423	D	2 mandos pared	Ø150mm	Flexo 1/2"	20

Victoria

SERIE



Fontanería Grifería

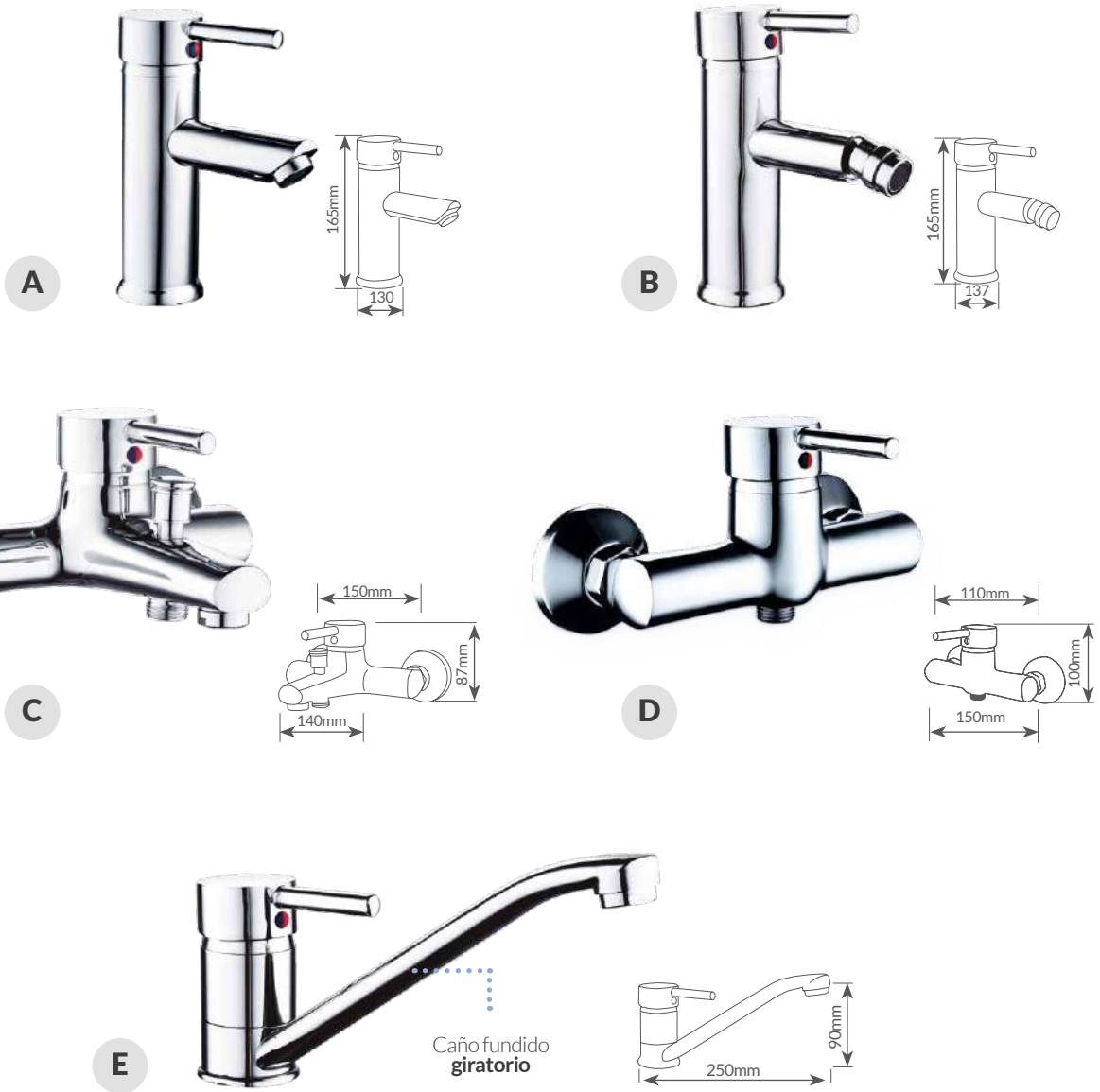

Monomandos Serie Victoria

Acabado cromado. Cartucho de discos cerámicos 40mm. Color: níquel satín.
 Latiguillos incluidos para referencias 003702430-31-33. Realce base de latón. Con bolsa acolchada para protegerlos.

Referencia	Artículo	Tipo	Diámetro	Conexión	Embalaje
003702430	A	Lavabo	Ø40mm	Latiguillo 3/8" - 360mm	15
003702431	B	Bidet	Ø40mm	Latiguillo 3/8" - 360mm	15
003702432	C	Baño	Ø40mm	1/2"	12
404025001	D	Ducha	Ø40mm	14mm	12
003702433	E	Fregadero	Ø40mm	Latiguillo 3/8" - 360mm	15



Herrajes y accesorios muebles

Ferretería

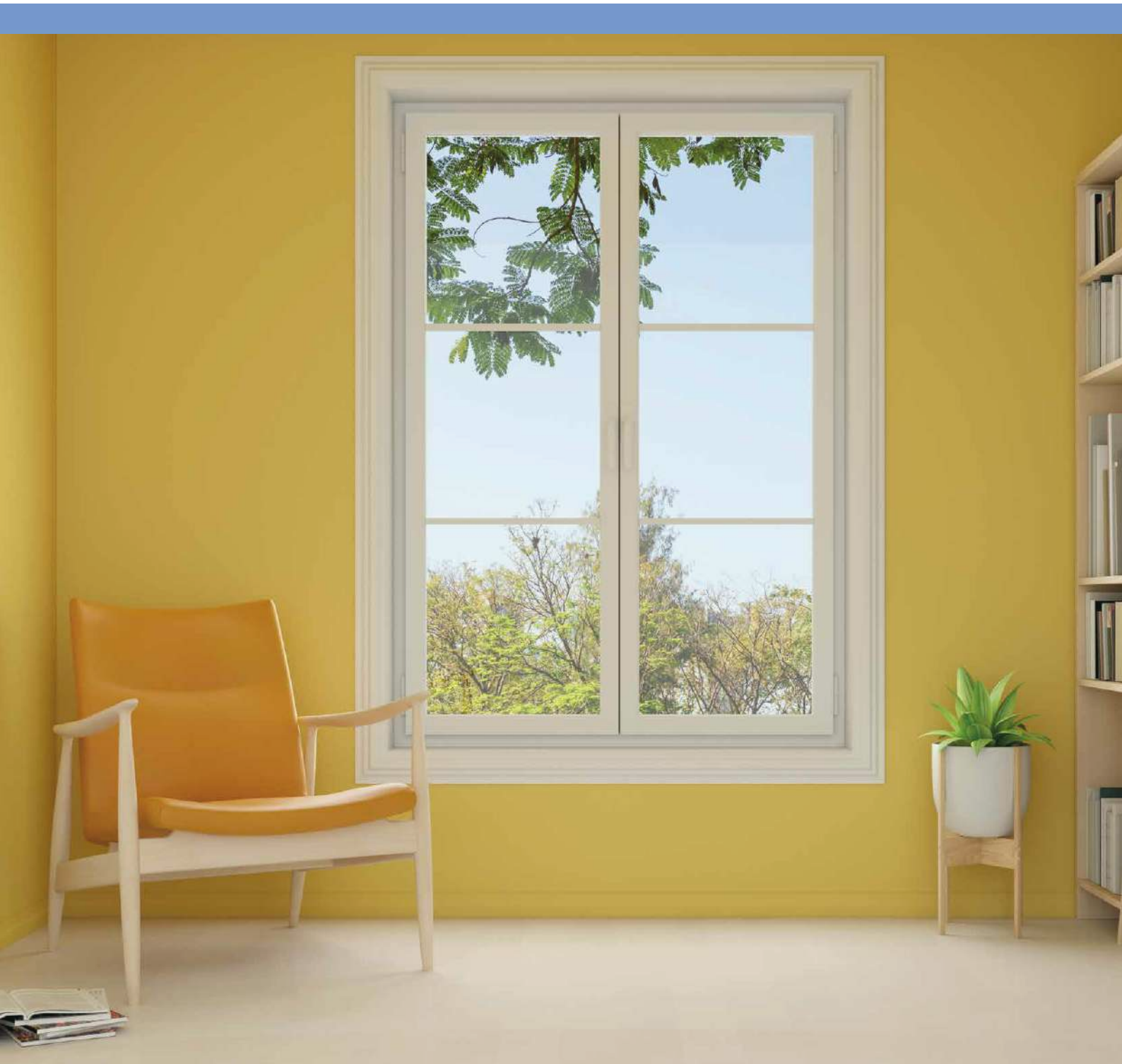



Escuadra metálica

Extremo **redondo**. Grosor: **0.8mm**. Ángulo recto: **90°**. Material: acero. Color blanco.

Referencia	Ancho	Profundo	Alto	Embalaje
003802701	35mm	125mm	100mm	24/480
003802702	36mm	150mm	125mm	24/480
003802707	49mm	400mm	350mm	24/120
003802708	53mm	450mm	400mm	24/72



Escuadra ángulo recto

Extremo **recto**. Ángulo recto: **90°**. Material: acero. Acabado **zinc**. Canto cuadrado.

Referencia	Ancho	Profundo / Alto	Grosor	Embalaje
003802718	19mm	75mm	2mm	100/400
003802719	19mm	100mm	2mm	50/200

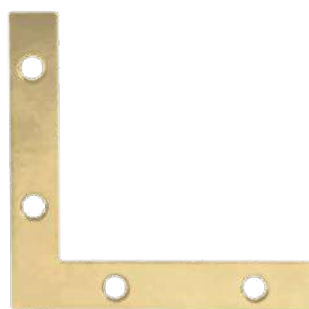

Escuadra metálica plana

Extremo **recto**. Ángulo recto: **90°**. Acabado **bricomatado**. Canto cuadrado. Ideal para puertas y ventanas.

Referencia	Ancho	Profundo	Alto	Grosor	Embalaje
003802727	10mm	20mm	40mm	1.6mm	250/1000
003802728	13mm	30mm	60mm	1.6mm	200/800
003802730	16mm	50mm	100mm	1.8mm	200/800

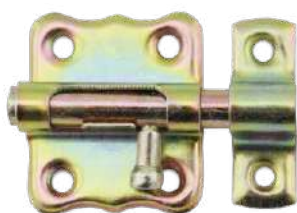

Pasador cerrojo

Material: acero. Acabado: **bricomatado**.

Referencia	Ancho	Pasador	Soporte	Alto	Grosor	Embalaje
003802736	38mm	25mm	11mm	34mm	0.8mm	20/400
003802737	46mm	30mm	11mm	36mm	0.8mm	20/400
003802738	54mm	35mm	11mm	36mm	0.8mm	20/400
003802739	59mm	40mm	14mm	38mm	1.0mm	20/400
003802740	59mm	50mm	14mm	38mm	1.0mm	20/400



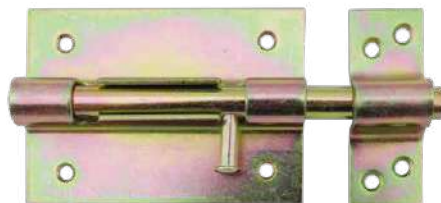

Pasador cerrojo

Material: acero. Acabado: **bricomatado**. Con orificio para candado.

Referencia	Ancho	Pasador	Soporte	Alto	Grosor	Embalaje
003802741	106mm	70mm	27mm	70mm	2mm	10/60
003802742	128mm	85mm	27mm	70mm	2mm	10/60
003802743	149mm	100mm	27mm	70mm	2mm	10/40



Soporte para baldas

Color: níquel satin. Soporta **grosos de balda de 4 a 25mm**.

Referencia	Ancho	Profundo	Alto	Embalaje
003802744	84mm	72mm	35mm	10/100



Tope para puerta

Color: níquel satín. Tipo: **semiesférico**. Fijación con tornillo incluido.

Referencia	Diámetro	Semiesfera	Embalaje
003802745	Ø45mm	25mm	50/500



Tope para puerta

Color: níquel satín. Tipo: **cilíndrico**. Fijación con tornillo incluido.

Referencia	Diámetro	Alto	Embalaje
003802746	Ø36mm	45mm	50/500



Tope para puerta de PVC

Color: transparente. Tipo: **cuña**. Material: **PVC**.

Referencia	Ancho	Profundo	Alto	Embalaje
003803802	96mm	13mm	38mm	100



A



B



C

Percha colgador

Material: **zamak**. Acabado brillo. Anclaje con tornillos incluidos.

Referencia	Artículo	Tipo	Ancho	Profundo	Alto	Embalaje
003802747	A	Simple	19mm	41mm	48mm	50/500
003802748	B	Doble	72mm	41mm	48mm	50/500
003802749	C	Vertical	25mm	72mm	96mm	20/200



C



D

Pack 3 perchas medianas adhesivas

Orificio con tornillo para superficies porosas o con poca adherencia.

Incluye tornillo de fijación y tacos. Material: **acero inoxidable**. Adhesivo de alta calidad. Blíster de 3 unidades.

Referencia	Artículo	Color	Ancho	Alto	Profundo	Embalaje
003802791	C	○ Lacado blanco	26mm	43mm	0.8mm	100
003802792	D	● Cromado mate	26mm	43mm	0.8mm	100





A



B

Pack 3 perchas adhesivas

Material: **PS**. No necesita tornillos.
Adhesivo extraíble y no daña la pared ni la pintura. Pack 3 unidades.

Referencia	Artículo	Color	Soporta	Instalación	Dimensión	Embalaje
500010000	A	○ Blanco	2Kg	Adhesiva	35x25x56mm	24/144
500010002	B	○ Transparente	2Kg	Adhesiva	35x25x56mm	24/144



C



D

Pack 4 perchas adhesivas

Material: **PS**. No necesita tornillos.
Adhesivo extraíble y no daña la pared ni la pintura. Pack 4 unidades.

Referencia	Artículo	Color	Soporta	Instalación	Dimensión	Embalaje
500010001	C	○ Blanco	2Kg/ 1Kg	Adhesiva	35x25x55mm 25x16x36mm	24/144
500010003	D	○ Transparente	2Kg/ 1Kg	Adhesiva	35x25x55mm 25x16x36mm	24/144





A



B



C

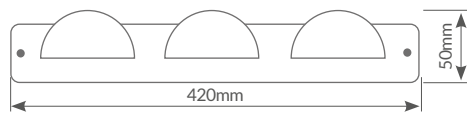
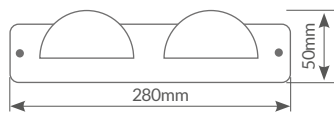
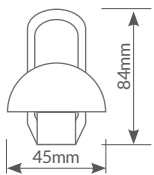

Perchas semicirculares

Material: base de **acero inoxidable** y pomo de **ABS**. Incluye tacos y tornillos.
Diseño en forma circular para evitar desperfectos en la ropa.

Referencia	Artículo	Tipo	Color	Embalaje
003802793	A	1 pomo	○ Lacado blanco	100
003802794	A	1 pomo	● Cromado mate	100
003802795	B	2 pomos	○ Lacado blanco	100
003802796	B	2 pomos	● Cromado mate	100
003802797	C	3 pomos	○ Lacado blanco	100
003802798	C	3 pomos	● Cromado mate	100



A

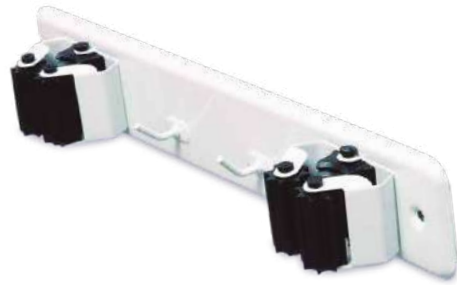

B

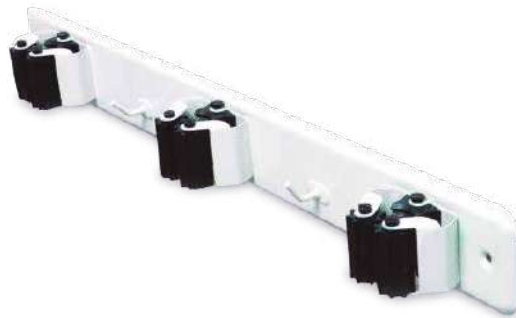

C

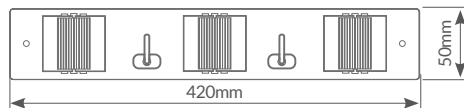
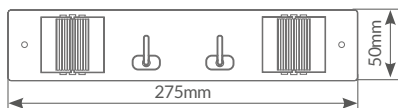
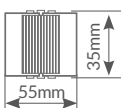

Sujeta escobas con rodillos

Material: **acero inoxidable**. Con rodillo de goma para una colocación más sencilla y un **agarre perfecto** del mango. También se puede colocar con **tacos y tornillos** desmontando el pasador de la zapatilla central.

Adhesivo de alta calidad.

Referencia	Artículo	Rodillos	Color	Embalaje
003803800	A	1	○ Lacado blanco	100
003803801	A	1	● Cromado mate	100
003803803	B	2	○ Lacado blanco	50
003803804	C	3	○ Lacado blanco	50

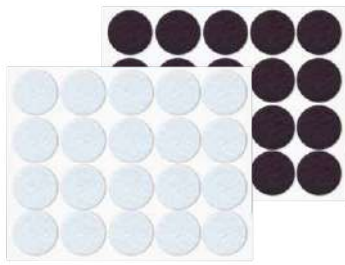

A

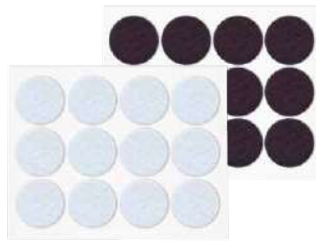

B



C



D



E



F



G

Filtro adhesivo protector

Tipo: **redondo. Adhesivo transfer acrílico** de alta adherencia.
Ideal para proteger el suelo de ralladuras, evitar molestos ruidos, etc.

Referencia	Artículo	Color	Diámetro	Grosor	Unidades	Embalaje
003802750	A	○ Blanco	Ø16mm	2.5~3mm	20	100
003802757	A	● Marrón	Ø16mm	2.5~3mm	20	100
003802751	B	○ Blanco	Ø20mm	2.5~3mm	12	100
003802758	B	● Marrón	Ø20mm	2.5~3mm	12	100
003802752	C	○ Blanco	Ø25mm	2.5~3mm	8	100
003802759	C	● Marrón	Ø25mm	2.5~3mm	8	100
003802753	D	○ Blanco	Ø30mm	2.5~3mm	6	100
003802760	D	● Marrón	Ø30mm	2.5~3mm	6	100
003802754	E	○ Blanco	Ø35mm	2.5~3mm	4	100
003802761	E	● Marrón	Ø35mm	2.5~3mm	4	100
003802755	F	○ Blanco	Ø38mm	2.5~3mm	4	100
003802762	F	● Marrón	Ø38mm	2.5~3mm	4	100
003802756	G	○ Blanco	Ø42mm	2.5~3mm	3	100
003802763	G	● Marrón	Ø42mm	2.5~3mm	3	100



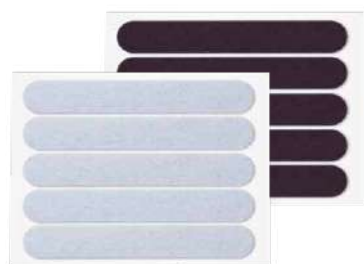

A

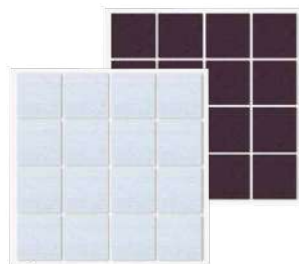

B

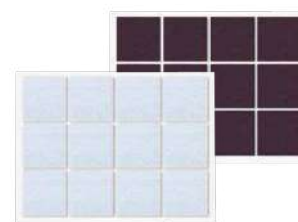

C



D



E



F

Filtro adhesivo protector

Tipo: **cuadrado Adhesivo transfer acrílico** de alta adherencia.
Ideal para proteger el suelo de ralladuras, evitar molestos ruidos, etc.

Referencia	Artículo	Color	Dimensión	Grosor	Unidades	Embalaje
003802764	A	○ Blanco	13x91mm	2.5~3mm	5	100
003802770	A	● Marrón	13x91mm	2.5~3mm	5	100
003802765	B	○ Blanco	16x20mm	2.5~3mm	16	100
003802771	B	● Marrón	16x20mm	2.5~3mm	16	100
003802766	C	○ Blanco	20x23mm	2.5~3mm	12	100
003802772	C	● Marrón	20x23mm	2.5~3mm	12	100
003802767	D	○ Blanco	28x44mm	2.5~3mm	5	100
003802773	D	● Marrón	28x44mm	2.5~3mm	5	100
003802768	E	○ Blanco	44x38mm	2.5~3mm	4	100
003802774	E	● Marrón	44x38mm	2.5~3mm	4	100
003802769	F	○ Blanco	100x85mm	2.5~3mm	1	100
003802775	F	● Marrón	100x85mm	2.5~3mm	1	100





Rollo fieltro adhesivo protector

Adhesivo transfer acrílico de alta adherencia.
Ideal para proteger el suelo de ralladuras, evitar molestos ruidos, etc.

Referencia	Artículo	Color	Ancho	Longitud	Embalaje
003802776	A	○ Blanco	25mm	1M	100
003802777	A	○ Blanco	25mm	2M	100
003802778	B	● Marrón	25mm	1M	100
003802779	B	● Marrón	25mm	2M	100

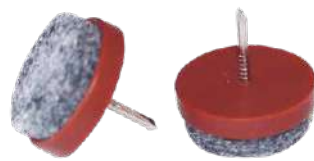

Deslizador de fieltro con clavo

Tipo: **redondo**. Con clavo. Ideal para proteger el suelo de ralladuras, evitar molestos ruidos, etc.

Referencia	Color	Diámetro	Unidades	Embalaje
003802780	● Marrón	Ø17mm	8	100
003802781	● Marrón	Ø20mm	8	100
003802782	● Marrón	Ø24mm	8	100
003802783	● Marrón	Ø28mm	4	100
003802784	● Marrón	Ø35mm	4	100

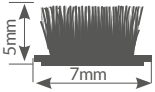

Burlete adhesivo con flecos

Tipo: **ventanas**. Color: gris. Ideal **para instalar en el rail**, recomendado para evitar las corrientes de aire en las ventanas correderas, no aconsejable para aislar del agua.

Referencia	Ancho	Grosor	Longitud	Embalaje
003803805	7mm	5mm	6M	100

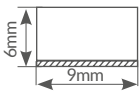

Burlete con espuma

Tipo: para **puertas y ventanas**. Color: blanco. Perfecto para instalar en soportes de PVC, aluminio y madera. Ideal para **aislar del calor, frío, ruido y polvo**.

Referencia	Ancho	Grosor	Longitud	Embalaje
003803806	9mm	6mm	10M	30/120
003803807	12mm	6mm	10M	30/120

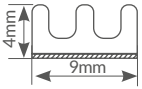

Burlete adhesivo de caucho

Tipo: para **puertas y ventanas**. Grosor: 4mm.
 Perfecto para instalar en soportes de PVC, aluminio y madera.
 Ideal para **aislar del calor, frío, ruido y polvo**.

Referencia	Color	Ancho	Longitud	Embalaje
003803808	○ Blanco	9mm	6M	24
003803809	● Marrón	9mm	6M	24

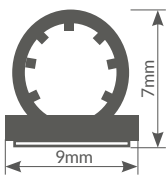

Burlete adhesivo de silicona

Adhesivo de alta adherencia.
 Perfecto para **ventanas de PVC, aluminio y madera**.
 Ideal para **aislar del calor, frío, ruido y polvo**.

Referencia	Color	Ancho	Grosor	Longitud	Embalaje
500000002	○ Blanco	9mm	7mm	6M	24/96
500000003	○ Transparente	9mm	7mm	6M	24/96

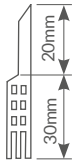

Burlete adhesivo de silicona

Adhesivo de alta adherencia. Perfecto para puertas.
Perfecto para instalar en soportes de PVC, aluminio y madera.
Ideal para aislar del calor, frío, ruido y polvo.

Referencia	Color	Ancho	Longitud	Embalaje
500000004	○ Blanco	50mm	1M	24/96



Burlete PVC adhesivo con flecos

Adhesivo de alta adherencia. Perfecto para puertas.
Perfecto para instalar en soportes de PVC, aluminio y madera.
Ideal para aislar del calor, frío, ruido y polvo.

Referencia	Color	Ancho	Longitud	Embalaje
003803810	○ Blanco	45mm	1M	24/96
003803811	● Marrón	45mm	1M	24/96
500000005 ★	● Plata	45mm	1M	24/96





Burlete PVC adhesivo de goma

Adhesivo de alta adherencia. Perfecto **para puertas.**
 Perfecto para instalar en soportes de PVC, aluminio y madera.
 Ideal para **aislar del calor, frío, ruido y polvo.**

Referencia	Color	Ancho	Longitud	Embalaje
003803812	○ Blanco	45mm	1M	24/96
003803813	● Marrón	45mm	1M	24/96
500000006 ★	● Plata	45mm	1M	24/96

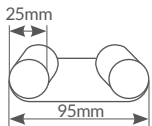

Doble rollo aislante

Perfecto **para colocar bajo las puertas.**
 Instalación fácil y rápida. **Protege contra el polvo y corrientes de aire frío.**
 Lámina flexible no adhesiva de PVC y recubrimiento de poliéster. No adhesivo.

Referencia	Color	Ancho	Longitud	Embalaje
003803814	● Gris	25mm	0.95M	20
500000001 ★	○ Blanco	25mm	0.95M	20



Gotas adhesivas protectoras

Material: **PVC transparente**. Tipo: **redondas**.

Protector de objetos y amortiguador de cajones, puertas de armario, etc.

Referencia	Diámetro	Grosor	Unid.	Embalaje
003802785	Ø9mm	2mm	25	100
003802786	Ø10mm	5mm	25	100
003802787	Ø12mm	2.5mm	16	100
003802788	Ø12mm	4mm	16	100



Gotas adhesivas protectoras

Material: **PVC transparente**. Tipo: **redondas planas**.

Protector de objetos y amortiguador de cajones, puertas de armario, etc.

Referencia	Diámetro	Grosor	Unid.	Embalaje
003802789	Ø17mm	3mm	9	100





Protege esquinas de silicona

Para proteger las esquinas de los muebles.
Sirve para todas las esquinas. **Tamaño estándar.**

Referencia	Color	Unid.	Embalaje
003802790	<input type="radio"/> Transparente	4	100



35x55x55mm

Protege esquinas de espuma

Forma de "V". Material: **espuma.**
Para proteger las esquinas de los muebles, escaleras,... Pack 4 unidades.

Referencia	Color	Instalación	Emb.
500070008	<input checked="" type="radio"/> Beige	Adhesivo 3M	6/48

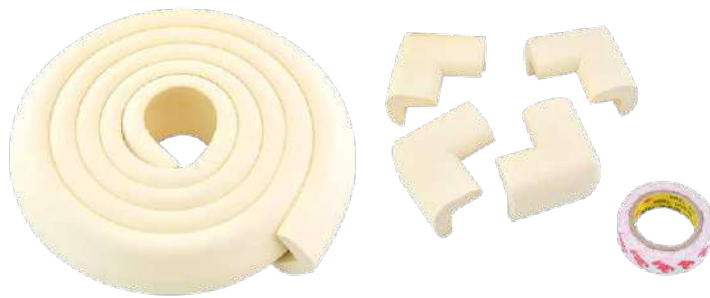

35x55x55mm
Protege esquinas

Rollo 2M + 4 protege esquinas de espuma

Protege esquinas con forma de "V". Material: **espuma**.
Rollo de 2M para cortar según se desee. Cinta adhesiva 3M incluida.

Referencia	Color	Instalación	Emb.
500070009	● Beige	Adhesivo 3M	16/32



94x92x18mm

Tope para puerta de goma eva

Para evitar que los niños se pillen los dedos. Pack 2 unidades.

Referencia	Color	Material	Emb.
500070000	○ Blanco	Goma EVA	50/100





31x68x33mm

Cierres para cajones / armarios

Material: **PP**. Incluye **4 cierres + 4 stoppers + 16 tornillos**. Pack 4 unidades.

Referencia	Color	Instalación	Emb.
500070001	○ Blanco	Con tornillos	24/144



50x7x205mm

Cierre seguridad puertas / armarios

Material: **ABS**. Para armarios, puertas, cajones, taza del WC, nevera,... Pack 2 unidades.

Referencia	Color	Instalación	Emb.
500070003	○ Blanco	Adhesivo 3M	24/144



34x13x192mm

Cierre seguridad puertas / armarios

Material: **ABS + PE**. Para armarios, puertas, cajones,...

Anchura regulable. Pack 3 unidades.

Referencia	Color	Instalación	Emb.
500070004	○ Blanco	Adhesivo 3M	50/100



93x75x50mm

Bloqueo para pomos de puertas

Material: **ABS**. Para manecillas que abren hacia arriba y hacia abajo. Pack 2 unidades.

Referencia	Color	Instalación	Embalaje
500070005	○ Blanco	Adhesivo 3M	50/100





10x20x17mm

Seguros para ventanas correderas

Material: **latón**. Incluye llave allen.
Pack 4 unidades.

Referencia	Color	Instalación	Embalaje
500070006	● Latón	A rosca	24/144



Protector para enchufe 2 polos

Color: blanco.

Referencia	Color	Pack	Embalaje
000200715	○ Blanco	10 unidades	450



Protector para enchufe sucko

Color: blanco.

Referencia	Color	Pack	Embalaje
000200063	○ Blanco	5 unidades	500



Protectores para mandos de cocina



Ø65x40mm

Material: **PC**. Ideal para colocar en **mandos de cocina y hornos**.
Pack 2 unidades.

Referencia	Color	Instalación	Embalaje
500070007	○ Transparente	A rosca	54/108





Herramientas y bricolaje

Ferretería

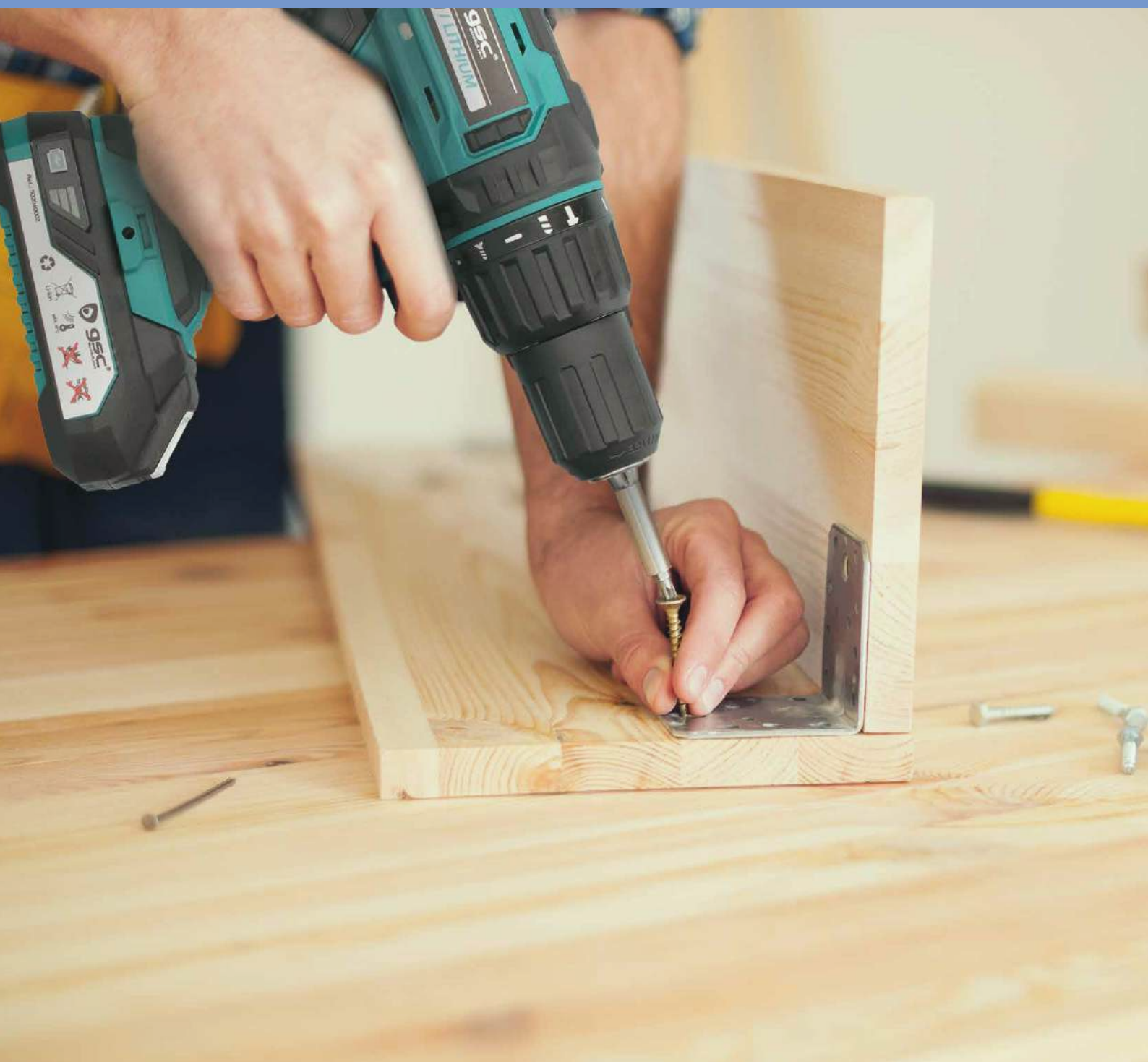



134x18x15mm

Cúter estándar manualidades

Display 24 unidades.

Material: **empuñadura ABS. Cuchilla de acero de carbono 9mm.**

Corte suave. **Botón bloqueo.** Agujero para colgar. Ideal para manualidades.

Referencia	Color	Embalaje
502030009	Azul / Gris	24/48
502085010	Recambio 10 cuchillas para cúter 9mm	



155x37.7x18.5mm

Cúter de seguridad

Display 24 unidades.

Material: **empuñadura nylon y fibra de vidrio. Cuchilla SK5 trapecoidales 19mm.**

Hoja retráctil 3 posiciones. **Bloqueo automático.** Agujero para colgar.

Referencia	Color	Embalaje
502030010	Azul / Gris	24/144
002102016	Recambio 10 cuchillas trapecoidales SK5	





168x35.5x21.5mm

Cúter estándar con rueda de bloqueo

Material: **empuñadura plástico** y **cuchillas acero de carbono**.
Bloqueo por giro. Con 3 cuchillas de 18mm. Blíster.

Referencia	Color	Embalaje
502030003	Azul / Gris	12/144
002100457	Recambio 10 cuchillas para cúter 18mm	



164x45x25mm

Cúter profesional autorecargable

Material: **empuñadura plástico** y **cuchillas acero de carbono**.
 Con 5 cuchillas de 18mm. Blíster.

Referencia	Cuchillas	Embalaje
502030001	Autorecargables	144
002100457	Recambio 10 cuchillas para cúter 18mm	



171.5x45x21mm

Cúter profesional **autorecargable**

Material: **empuñadura plástico** y **cuchillas acero de carbono**.
Bloqueo automático. Con 3 cuchillas de 18mm. Blíster.

Referencia	Color	Cuchillas	Embalaje
502030011	Azul / Gris / Negro	Autorecargables	12/144
002100457	Recambio 10 cuchillas para cúter 18mm		



168.4x36.8x22.4mm

Cúter seguridad **tipo navaja plegable**

Material: **empuñadura plástico** y **cuchillas SK5**. Tipo navaja, **plegable**.
Botón de liberación de cuchilla. Incluye 3 cuchillas 19mm, funda protectora para cuchilla y clip de sujeción. Blíster.

Referencia	Color	Embalaje
502030012	Azul / Gris	12/144
002102016	Recambio 10 cuchillas trapezoidales SK5	





178.5x48x24mm

Cúter seguridad 3 posiciones

Material: empuñadura plástico y cuchillas SK5.

Botón de liberación de cuchilla. Hoja retráctil 3 posiciones. Incluye 4 cuchillas 19mm. Blíster.

Referencia	Color	Embalaje
502030013	Azul / Gris	12/144
002102016	Recambio 10 cuchillas trapezoidales SK5	



130x64x21mm

Rasqueta de plástico

Ideal para quitar restos adheridos sobre azulejos, cristales o cualquier superficie plana. Mango de plástico. Cuchilla: 61x19x0.6mm. Blíster.

Referencia	Cuchilla	Embalaje
002101442	Acero templado	24/288
002101443	Recambio 10 hojas para rasqueta	



150x95mm

Rasqueta profesional

Ideal para quitar restos adheridos sobre azulejos, cristales o cualquier superficie plana. Mango de plástico. Incluye 5 cuchillas. Blíster.

Referencia	Cuchilla	Embalaje
401045024	Acero de carbono	12/72
401060005	Recambio 4 cuchillas para rasqueta	



Espátula de acero

Ideal para quitar restos adheridos sobre azulejos, cristales o cualquier superficie plana. Mango de plástico. Cuchilla: 61x19x0.6mm. Blíster.

Referencia	Cuchilla	Anchura lámina	Embalaje
503000002	Acero templado	50mm	12/120
503000001	Acero templado	100mm	12/120





Cinta métrica

Display 12 unidades.
Carcasa de plástico. Con **clip para cinturón**.

Referencia	Longitud	Anchura	Embalaje
002100458	3M	16mm	12/120



Cinta métrica

Fácil bloqueo y desbloqueo.
A prueba de golpes. Con clip para cinturón.
Recubierta de goma. Con **botón de parada**. Blíster.

Referencia	Longitud	Anchura	Embalaje
002100459	3M	16mm	12/120
002100460	5M	19mm	12/120



Cinta métrica

Fácil bloqueo y desbloqueo. A prueba de golpes. Con clip para cinturón. Recubierta de goma. Con **botón de parada e imán en la extremidad**. Blíster.

Referencia	Longitud	Anchura	Embalaje
002100461	3M	16mm	12/120
002100462	5M	19mm	12/120
002100463	8M	25mm	6/60



Cinta métrica

Fácil bloqueo y desbloqueo. A prueba de golpes. Con clip para cinturón. Recubierta de goma. Con **3 botones de parada diferentes e imán en la extremidad**. Blíster.

Referencia	Longitud	Anchura	Embalaje
002100896	5M	19mm	12/120



Cinta métrica

Display 12 unidades.

Fácil bloqueo y desbloqueo. A prueba de golpes. Con clip para cinturón.
Recubierta de goma. Con **botón de parada.**

Referencia	Longitud	Anchura	Embalaje
002101252	5M	19mm	12/120



Pistola silicona de aluminio

Funcionamiento a muelle.

Referencia	Embalaje
001401331	40





Pistola silicona con fuelle

Compatible con **cartuchos de 300ml. y 400ml.**
Incluye: aplicador, bastidor, boquilla. Funcionamiento a muelle.

Referencia	Embalaje
502045002	12/24



Alicate sacabocados perforador

Hasta 6 tipos de agujeros:
2.5mm, 3mm, 3.5mm, 4mm, 4.5mm, 5mm.

Referencia	Embalaje
003202095	24





Grapadora industrial manual

Certificado ISO 9001. Ideal para aislamientos, envoltura de casa, techos, cableado, alfombras, tapicería.

Referencia	Grapas	Embalaje
502045000	De 4 a 8mm	6/24



Caja de grapas

Para grapadora manual. Caja de 1000 grapas.

Referencia	Grapas	Embalaje
502045001	4mm	200
003202092	6mm	200
003202093	8mm	200
003202094	10mm	200



Destornillador Phillips

Material: **romo vanadio con punta reforzada**. Punta imantada.

Referencia	Dimensión	Embalaje
502035011	PH0x75mm	12/240
502035024	PH1x25mm	12/ 240
502035012	PH1x100mm	12/ 240
502035013	PH1x150mm	12/ 240
502035014	PH1x250mm	12/ 240
502035025	PH2x25mm	12/ 240
502035015	PH2x100mm	12/ 120
502035016	PH2x150mm	12/ 120
502035017	PH2x250mm	12/ 240
502035018	PH3x150mm	12/ 120



Destornillador plano

Material: **cromo vanadio con punta reforzada**. Punta imantada.

Referencia	Dimensión	Embalaje
502035019	4x100mm	12/240
502035026	5.5x25mm	12/240
502035020	5.5x125mm	12/240
502035027	6.5x25mm	12/240
502035021	6.5x150mm	12/120
502035022	8x175mm	12/120
502035023	10x200mm	12/120



Destornillador aislante Phillips

Material: **romo vanadio con punta reforzada**. Punta imantada.

Referencia	Dimensión	Embalaje
502035002	PH0x75mm	12/72
502035001	PH1x80mm	12/72
502035003	PH2x100mm	12/72



Destornillador aislante plano

Material: **romo vanadio con punta reforzada**. Punta imantada.

Referencia	Dimensión	Embalaje
502035004	3x75mm	12/72
502035005	4x100mm	12/72
502035006	5.5x125mm	12/72
502035007	6.5x150mm	12/72



Destornillador buscapolos

Medición de **100V a 250V** AC. Tolerancia corriente **AC y DC**. Blíster.

Referencia	Longitud	Embalaje
001400111	140mm	25/100



Set 7 destornilladores de alta precisión

7 piezas: 3 Phillips / 4 Planos.

PUNTAS	MODELOS
Phillips	PH00x50 / PH0x50 / PH1x50
Plana	1.5x50 / 2x50 / 2.5x50 / 3x50

Referencia	Material	Embalaje
502035028	Cromo vanadio	10/60

Set 6 destornilladores de alta precisión

6 piezas: 2 Phillips / 4 Planos.

PUNTAS	MODELOS
Phillips	PH0 / PH1
Plana	1.4 / 2.0 / 2.4 / 3.0mm

Referencia	Material	Embalaje
502035032	Acero de carbono	100/200



Set 18 piezas destornillador de precisión

18 piezas. Base imantada. Destornillador con carraca. Incluye barra extensible de 120mm.

PUNTAS	MODELOS
Plana	1/2/3/4 mm
Phillips	PH000/PH00/PH0/PH1
Torx	T6/T7/T8/T9
Hexágono	1.5/2/2.5/3 mm

Referencia	Material	Embalaje
502035029	Cromo vanadio	10/40

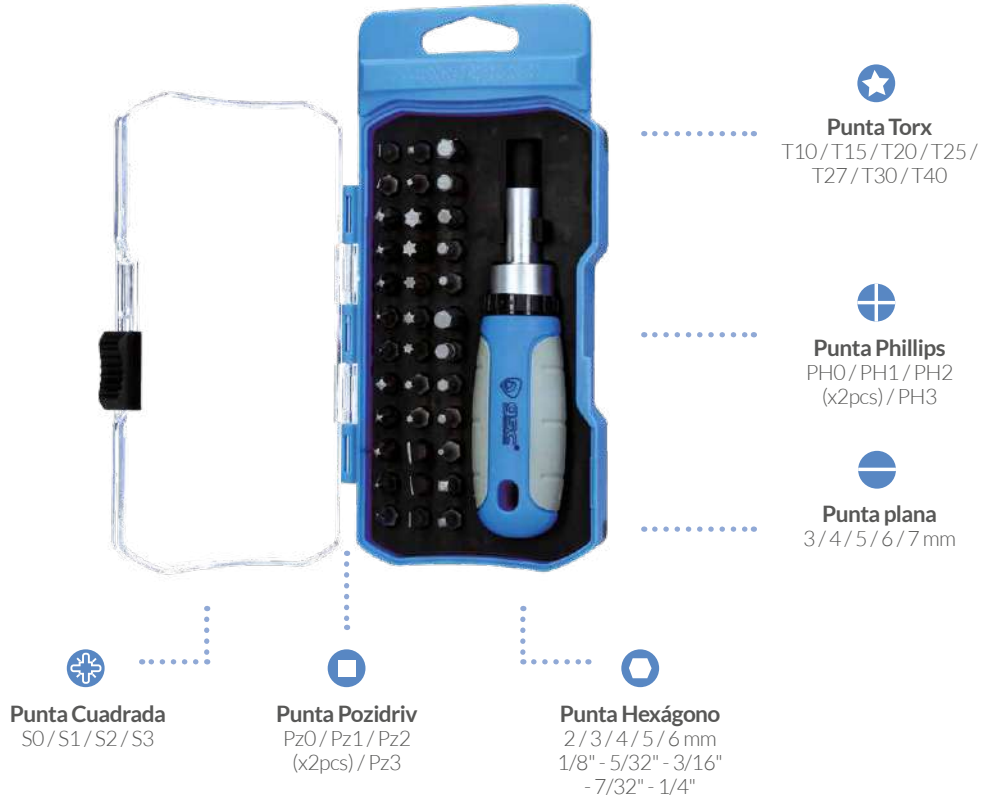

Set 37 piezas destornillador de precisión con carraca

37 piezas. Base imantada. Destornillador con carraca.

PUNTAS	MODELOS	PUNTAS	MODELOS
Plana	● 3/4/5/6/7 mm	Hexágono	○ 2/3/4/5/6 mm 1/8" - 5/32" - 3/16" - 7/32", 1/4"
Phillips	⊕ PH0/PH1/PH2 (x2pcs)/PH3	Pozidriv	⊕ Pz0/Pz1/Pz2 (x2pcs)/Pz3
Torx	★ T10/T15/T20/T25/T27/T30/T40	Cuadrada	□ S0/S1/S2/S3

Referencia	Material	Embalaje
502035030	Cromo vanadio	10/40



Kit de herramientas básicas hogar

26 piezas. 9 puntas: planas (4 / 5 / 6mm), Phillips (PH1 / PH2 / PH3) y torx (T10 / T15 T20).
1 mango conector de destornillador, 1 adaptador para bocallaves, un juego de 5 bocallaves con encastre 1/4" de 7 / 8 / 9 / 10 / 11mm, una barra extensible de 80mm, un cúter, 2 alicates universales de cortes y 4 destornilladores (PH0x40mm, PH1x40mm, SL 2.4x40mm, SL 3.0x40mm).

Referencia	Nº piezas	Embalaje
502035031	26	6/24



Set 4 destornilladores

Material: **cromo vanadio con punta reforzada.**

PUNTAS	MODELOS
Plana	5x100 / 6x125mm
Phillips	PH1x100mm / PH2x125mm

Referencia	Tipo	Embalaje
502035009	2 Planos / 2 Phillips	10/40

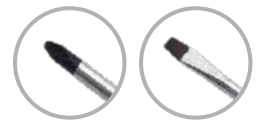

Set 6 destornilladores

Material: **cromo vanadio con punta reforzada**

PUNTAS	MODELOS
Plana	4x80 / 5x100 / 6x125mm
Phillips	PH0x80mm / PH1x100mm / PH2x125mm

Referencia	Tipo	Embalaje
502035008	3 Planos / 3 Phillips	10/20



Mini-alcate universal

Material: **acero cromo vanadio**. Ideal para trabajos de precisión.

Referencia	Longitud	Embalaje
002901254	120mm	12/120



Mini-alcate boca plana

Material: **acero cromo vanadio**.
Ideal para trabajos de precisión.

Referencia	Longitud	Embalaje
002900070	120mm	12/120



Mini-alcate boca semiredonda

Material: **acero cromo vanadio**.
Ideal para trabajos de precisión.

Referencia	Longitud	Embalaje
002900071	120mm	6/60



Alicate universal

Material: **acero cromo vanadio**. Con empuñadura ergonómica de seguridad. Indicados para sujetar pequeños objetos, apretar tuercas y doblar alambres.

Referencia	Longitud	Embalaje
502000001	160mm	6/60
502000002	180mm	6/60
502000003	200mm	6/60



Alicate corte diagonal

Material: **acero cromo vanadio**. Con empuñadura ergonómica de seguridad. Indicados para alambres y cables eléctricos sin tensión.

Referencia	Longitud	Embalaje
502000004	160mm	6/60
502000005	200mm	6/60



Alicate boca semiredonda

Material: **acero cromo vanadio**. Con empuñadura ergonómica de seguridad.
Cabezal extralargo para la introducción de componentes situados a mayor profundidad.

Referencia	Longitud	Embalaje
502000006	160mm	6/60



Alicate pelacables

Material: **acero cromo vanadio**.
Para pelar cables de Ø5 a 10mm².
Con empuñadura ergonómica de seguridad.

Referencia	Longitud	Embalaje
502000008	160mm	6/60



Alicate corte diagonal con pelacables y crimpadora

Material: **acero cromo vanadio.**

Para pelar cables: 1.0 / 1.3 / 1.6 / 2.0 / 2.6mm².

Para crimpar cables: Ø0.5-1.0mm² / Ø1.5-2.5mm².

Empuñadura ergonómica.

Referencia	Longitud	Embalaje
502000019	200mm	6/36



Alicate universal con pelacables y crimpadora

Material: **acero cromo vanadio.**

Para pelar cables: 1.0 / 1.3 / 1.6 / 2.0 / 2.6mm².

Para crimpar cables: Ø0.5-1.0mm² / Ø1.5-2.5mm².

Empuñadura ergonómica.

Referencia	Longitud	Embalaje
502000018	215mm	6/36



Crimpadora 185mm

Apto para conectores: 8P8C/RJ-45, 6P6C/RJ-12, 6P4C/RJ-11.
Empuñadura ergonómica.

Referencia	Longitud	Embalaje
502000015	185mm	10/50



Abridor de botellín

Material: **acero de carbono**.
Empuñadura ergonómica.

Referencia	Dimensión	Embalaje
401045028	158x42mm	12/144





Alicate universal electricista

Material: **acero cromo vanadio**. Mango aislante.
Soporta de 0 a 1000V.

Referencia	Longitud	Embalaje
502000009	180mm	6/60
502000010	200mm	6/60



Alicate corte diagonal electricista

Material: **acero cromo vanadio**. Mango aislante.
Soporta de 0 a 1000V.

Referencia	Longitud	Embalaje
502000011	180mm	6/60



Tijeras electricista

Material: **ABS + termoplástico**. Diseño ergonómico.
 Hoja de acero inoxidable con **muesca de 6mm** para el pelado de cable. Blíster.

Referencia	Dimensión	Embalaje
002900044	75x142mm	12/120



Llave inglesa ajustable

Material: **acero al carbono pulido**. Escala graduada.

Referencia	Longitud	Embalaje
502055035	150mm	12/72
502055036	200mm	12/72
502055037	250mm	12/60
502055038	300mm	12/36





Alicate de presión

Material: **acero cromo vanadio**. Acabado cromado.
Mordaza **bloqueable**. Boca con tratamiento térmico. Con palanca de desbloqueo.

Referencia	Longitud	Embalaje
502055002	250mm	6/36



Tenaza pico-loro

Material: **acero cromo vanadio**.
Mango aislante reforzado con guarda dedos y bocas pulidas.

Referencia	Longitud	Embalaje
502055001	250mm	6/48



Tenaza rusa

Material: **acero de carbono**.
Mango aislante reforzado.

Referencia	Longitud	Embalaje
502055003	200mm	6/48

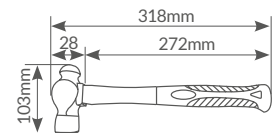

Martillo de bola

Mango: de **fibra de vidrio**. Ideal para tratar metal y remachar trabajo de forja, cerrajería o mecánica.

Referencia	Peso	Embalaje
502060006	450gr.	6/24



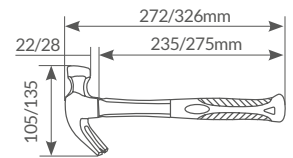

Martillo encofrador

Mango: de **fibra de vidrio**. Posee **doble uña** en la parte posterior para extraer clavos u otros objetos con facilidad. Ideal para pequeños trabajos de demolición.

Referencia	Peso	Embalaje
502060005	230gr.	6/60
502060004	450gr.	6/36

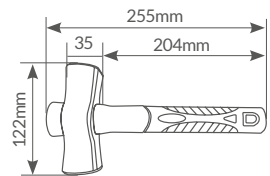

Maceta española

Mango: de **fibra de vidrio**. Ideal para pequeños trabajos de demolición y para usar con una mano.

Referencia	Peso	Embalaje
502060007	1000gr.	6/12

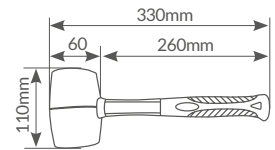

Maza de goma

Mango: de **fibra de vidrio**.

Ideal para nivelación y colocación de piezas tanto en suelo como en chapado de paredes.

Referencia	Peso	Embalaje
502060008	670gr.	12/24

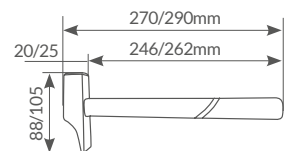

Martillo carpintero

Mango: de **madera**. Martillo clásico para clavar clavos. Fácil manejo.

Referencia	Peso	Embalaje
502060001	160gr.	6/60
502060003	300gr.	6/48



Llave combinada

Material: **chromo vanadio**.

Referencia	Dimensión	Embalaje
502055004	6mm	400
502055005	7mm	400
502055006	8mm	400
502055011	9mm	300
502055007	10mm	300
502055008	11mm	240
502055009	12mm	240
502055010	13mm	240
502055012	14mm	240
502055013	15mm	180
502055014	16mm	180
502055015	17mm	180
502055016	18mm	120
502055017	19mm	120
502055018	20mm	120





Llave fija

Material: **cromo vanadio**.

Referencia	Dimensión	Embalaje
502055019	6mm / 7mm	400
502055020	10mm / 12mm	300
502055021	12mm / 13mm	240
502055022	14mm / 15mm	240
502055023	16mm / 17mm	180
502055024	18mm / 19mm	120
502055025	20mm / 21mm	120





Llave combinada con carraca

Material: **chromo vanadio**.

Referencia	Dimensión	Embalaje
502055027	8mm	10/100
502055028	10mm	10/100
502055029	11mm	10/100
502055030	13mm	10/100
502055031	14mm	10/100
502055032	17mm	10/100



Set 6 llaves inglesas fijas

Material: **romo vanadio**.

Apertura de mordaza: 6x7mm / 8x9mm / 10x11mm / 12x13mm / 14x15mm / 16x17mm.

Referencia	Apertura mordaza	Embalaje
502055026	De 6 a 17mm	5/20



Set bocallaves

Material: **romo vanadio**. Con barra extensible de 100mm.

Encastre 1/2". 10 bocallaves estriadas: 8 / 9 / 10 / 11 / 12 / 14 / 17 / 19 / 21 / 24.

Referencia	Apertura mordaza	Embalaje
502055039	De 8 a 24mm	5/25





Set 9 llaves allen

Material: **chromo vanadio**.

Llaves: 1.5mm / 2mm / 2.5mm / 3mm / 4mm / 5mm / 6mm / 8mm / 10mm.

Referencia	Embalaje
502055041	10/40



Set 9 llaves torx

Material: **chromo vanadio**.

Llaves: T10 / T15 / T20 / T25 / T27 / T30 / T40 / T45 / T50.

Referencia	Embalaje
502055040	10/40



Set 8 llaves torx

Material: **romo vanadio.**

Llaves: T9/T10/T15/T20/T25/T27/T30/T40.

Referencia	Embalaje
502055034	10/40



Set 8 llaves allen

Material: **romo vanadio.**

Llaves: 1.5mm/2mm/2.5mm/3mm/4mm/5mm/6mm/8mm.

Referencia	Embalaje
502055033	10/40





Lima plana para metales

Material: **acero de carbono T12**. Forma: plana. Tipo de grano: fino.

Referencia	Longitud hoja	Embalaje
502030005	300mm	12/48



Lima semiredonda para madera

Material: **acero de carbono T12**. Forma: plana y redonda. Tipo de grano: grueso.

Referencia	Longitud hoja	Embalaje
502030004	300mm	12/48



Sierra de arco

Material sierra: **acero**. Dientes por pulgada: 24. Tipo de corte: **corte fino y a ras**.
 Tipo de dientes: **doblo filo**. Incluye una hoja de 300mm. Empuñadura de plástico.

Referencia	Longitud hoja	Embalaje
502030006	300mm	6/36
502085005	Recambio 2 hojas de sierra para 502030006 - 07	



Mini sierra

Material sierra: **acero**. Dientes por pulgada: 24. Tipo de corte: **corte fino y a ras**.
 Tipo de dientes: **doblo filo**. Incluye una hoja de 300mm. Sentido de corte: tirar y empujar. Empuñadura de plástico.

Referencia	Longitud hoja	Embalaje
502030007	300mm (visible la mitad)	6/36
502085005	Recambio 2 hojas de sierra para 502030006 - 07	



Sierra de costilla con caja de ingletes

Material sierra: **acero**. Múltiples ángulos de corte.
 Tipo de dientes: **dobles filo**. Incluye una hoja de 300mm. **Modo de fijación:** con sargento (no incluido).
 Dimensión base: 295x295x50mm. Empuñadura de plástico.

Referencia	Longitud hoja	Embalaje
502030008	300mm	50

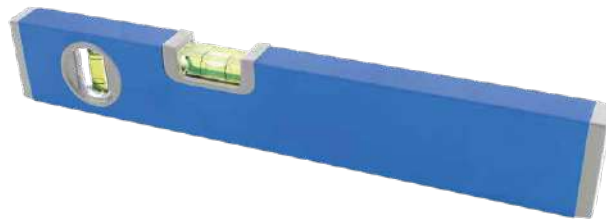

Nivel con lado magnético

Niveles de burbuja: **Precisión de medición:** 0.5. Con imán en un lateral.

Referencia	Longitud hoja	Viales burbuja	Ángulos viales	Embalaje
502065004	250mm	2	90° / 180°	30/60
502065005	450mm	3	45° / 90° / 180°	30/60



Atornillador

MINI INALÁMBRICO

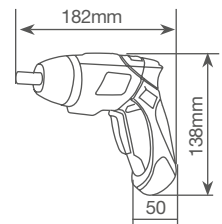

Mini atornillador inalámbrico

Con batería recargable Li-Ion de 1300mAh (incluida). **Revoluciones por minuto:** 180 RPM. **Torsión máxima:** 4Nm. **Broca 1/4" hexagonal.** Botón de **bloqueo automático.** Tiempo de carga 1-2h. Luz LED de trabajo. Incluye 24 piezas. **18 puntas de 25mm. 2 puntas de 50mm. 3 brocas hexagonales. 1 porta puntas magnético de 55mm.** Sin cable. Empuñadura de goma texturizada. Diseño ergonómico, ligero y compacto. Rápido, preciso y duradero.

Referencia	Potencia	Voltaje	RPM	Embalaje
502040006	60W	3.6V	180	10



Atornillador

MINI INALÁMBRICO

Herramientas y bricolaje Herramientas eléctricas



Mini atornillador inalámbrico

Con **batería recargable Li-Ion** de 1300mAh (incluida). **Revoluciones por minuto:** 180 RPM. **Torsión máxima:** 4Nm. **Broca 1/4" hexagonal.** Botón de **bloqueo automático.** Tiempo de carga 3-5 horas. Luz LED de trabajo. Incluye 24 piezas. **18 puntas de 25mm. 2 puntas de 50mm. 3 brocas hexagonales. 1 porta puntas magnético de 55mm.** **Sin cable.** Empuñadura de goma texturizada. Diseño ergonómico, ligero y compacto. Rápido, preciso y duradero.

Referencia	Potencia	Voltaje	RPM	Embalaje
502040001	30W	3.6V	180	200



Taladro ELÉCTRICA



Taladro **percutor eléctrico**

Revoluciones por minuto variable: de 0-3000 RPM.

Velocidad variable. Diámetro perforación: Ø2-13mm (hormigón), Ø25mm (madera), Ø10mm (acero).

Medidor de profundidad. Mango auxiliar incluido. Diseño ergonómico, ligero y compacto. Rápido, preciso y duradero.

Referencia	Potencia	Voltaje	RPM	Embalaje
003402002	650W	220-240V	0-3000	10

Taladro INALÁMBRICO

Herramientas y bricolaje Herramientas eléctricas



Taladro destornillador inalámbrico

Con **batería recargable Li-Ion** de 2000mAh (incluida). **Revoluciones por minuto variable:** de 0-440 / 0-1650 RPM.

Tasa de impacto: 0-7040 / 0-2640 BPM. Tiempo de carga 1 hora. **Velocidad variable.** **Freno eléctrico.**

Giro máximo en desatornillar: 50Nm. **Nivel de par de apriete:** 20+1. Incluye **portabrocas sin llave 2-13mm.**

Incluye **6 brocas de hormigón** y **6 destornilladores.** Pantalla LED indicadora de batería baja. Con **botón bloqueo.**

Luz LED de trabajo. Incluye clip de cinturón. Con banda magnética sujeción brocas. **Sin cable.**

Cambio fácil de taladro a destornillador y viceversa. Diseño ergonómico, ligero y compacto.

Rápido, preciso y duradero. Incluye cargador 2.4A. Maletín de transporte incluido.

Referencia	Potencia	Voltaje	RPM	Embalaje
502040002	350W	20V	0-440 / 0-1650	200
502085001	Batería 2.0A para herramientas ref. 502040000 - 02 - 03 - 04 - 05			
502085006	Batería 4.0A para herramientas ref. 502040000 - 02 - 03 - 04 - 05			
502085002	Cargador 2.4A para herramientas ref. 502040000 - 02 - 03 - 04 - 05			
502085007	Cargador 3.5A para herramientas ref. 502040000 - 02 - 03 - 04 - 05			



Caladora

ELÉCTRICA

Velocidad variable
500-3.000CPM

Capacidad máx. corte
madera Ø55-60mm
acero Ø6-8mm

Corte
inglete 45°



Sierra caladora eléctrica

Revoluciones por minuto: de 500-3000 RPM. **Velocidad variable.**

Perforación máxima en **madera: Ø55-60mm**. Corte de **inglete: 45°**. Perforación máxima en **acero: Ø6-8mm**.

Diseño ergonómico, ligero y compacto. Rápido, preciso y duradero.

Referencia	Potencia	Voltaje	RPM	Embalaje
003402004	500W	220-240V	500-3000	10

Caladora INALÁMBRICA



Herramientas y bricolaje Herramientas eléctricas

Sierra caladora inalámbrica

Con **batería recargable Li-Ion** de 2000mAh (incluida) **Carreras por minuto: 0-2.700 CPM. Velocidad variable.** Longitud de carrera: 20mm. Capacidad máx. de **corte en madera:** 80mm. Capacidad máx. de **corte en acero:** 5mm. Capacidad máx. de **corte en aluminio:** 12mm. Pantalla LED indicadora batería. **Extractor de polvo incluido.** Tiempo de carga 31min. Diseño ergonómico, ligero y compacto. **Sin cable.** Rápido, preciso y duradero. Incluye 2 sierras y cargador 2.4A. Maletín de transporte incluido.

Referencia	Potencia	Voltaje	CPM	Embalaje
502040004	530W	20V	0-2.700 CPM	4
502085001	Batería 2.0A para herramientas ref. 502040000 - 02 - 03 - 04 - 05			
502085006	Batería 4.0A para herramientas ref. 502040000 - 02 - 03 - 04 - 05			
502085002	Cargador 2.4A para herramientas ref. 502040000 - 02 - 03 - 04 - 05			
502085007	Cargador 3.5A para herramientas ref. 502040000 - 02 - 03 - 04 - 05			



Lijadora INALÁMBRICA

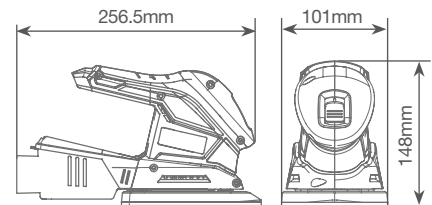

Lijadora inalámbrica

Botón de liberación de batería y botón On/Off. Pantalla LED indicadora batería. Incluye: **3 papeles de lija Delta (P60, P120, P180), cajón para el polvo y tubo de salida de polvo.** Tiempo de carga 56min. Diseño ergonómico, ligero y compacto. **Sin cable.**

Referencia	Voltaje	RPM	Embalaje
502040005	20V	11.000	4
502085001	Batería 2.0A para herramientas ref. 502040000 - 02 - 03 - 04 - 05		
502085006	Batería 4.0A para herramientas ref. 502040000 - 02 - 03 - 04 - 05		
502085002	Cargador 2.4A para herramientas ref. 502040000 - 02 - 03 - 04 - 05		
502085007	Cargador 3.5A para herramientas ref. 502040000 - 02 - 03 - 04 - 05		

Amoladora

INALÁMBRICA

Herramientas y bricolaje Herramientas eléctricas



Amoladora angular inalámbrica

Con **batería recargable Li-Ion** de 4000mAh (incluida). **Revoluciones por minuto:** 10.000 RPM. **Diámetro disco:** Ø115mm. **Disco de lija incluido.** Tuerca de brida M14. Mango auxiliar 2 posiciones. Pantalla LED indicadora batería. Con **botón de bloqueo** para cambio rápido de disco. Tiempo de carga 70min. Diseño ergonómico, ligero y compacto. **Sin cable.** Rápido, preciso y duradero. Incluye cargador 3.5A.

Referencia	Potencia	Voltaje	RPM	Embalaje
502040003	500W	20V	10.000 RPM	4
502085001	Batería 2.0A para herramientas ref. 502040000 -02 -03 -04 -05			
502085006	Batería 4.0A para herramientas ref. 502040000 -02 -03 -04 -05			
502085002	Cargador 2.4A para herramientas ref. 502040000 -02 -03 -04 -05			
502085007	Cargador 3.5A para herramientas ref. 502040000 -02 -03 -04 -05			

Amoladora

ELÉCTRICA



Amoladora angular eléctrica

Revoluciones por minuto: **11.000 RPM**. Diámetro disco: **Ø115mm**. Cabezal aluminio. Empuñadura con **3 posiciones**. LED aviso desgaste escobillas. **Con botón de bloqueo** para cambio rápido de disco. Rápida, precisa, duradera y profesional. Diseño ergonómico, ligero y compacto.

Referencia	Potencia	Voltaje	RPM	Embalaje
003402003	710W	220-240V	11.000 RPM	10





220-240V 50/60Hz

Soldador eléctrico estaño

Punta tipo lápiz de larga duración para una mejor soldadura. Blíster.

Referencia	Potencia	Cable	Embalaje
001401326	40W	1.5M	400



A Tubos



B Carretes



C Punta

Accesorios para soldador eléctrico

Accesorios para soldador eléctrico.

Referencia	Artículo	Tipo	Gramos	Grosor	Embalaje
001401348	A	Pack 10 tubos de estaño 60%	10gr.	1mm	10/20
001401327	B	Carrete de estaño 60%	100gr.	1mm	5/400
001401328	B	Carrete de estaño 60%	250gr.	1mm	5/100
001401349	C	Punta tipo lápiz	-	-	10/200



Mini pistola **silicona en barra**

Incluye **2 barras de silicona Ø7mm**. Longitud cable: **1.1M**.
Ideal para todo tipo de manualidades y pequeñas reparaciones domésticas. 220-240V. Blíster.

Referencia	Potencia	Embalaje
001403305	10W	100



Barra **silicona Ø7mm**

6 barras de silicona transparente. **Secado ultra rápido**. Para referencia 001403305.

Referencia	Dimensión	Embalaje
001403306	Ø7x100mm	10/100





Pistola silicona en barra

Incluye **6 barras de silicona Ø11mm**. Longitud cable: **1.2M**.
Ideal para todo tipo de manualidades y pequeñas reparaciones domésticas. 220-240V. Blíster.

Referencia	Potencia	Embalaje
001401329	60W	50



Barra silicona Ø11mm

6 barras de silicona transparente. **Secado ultra rápido**. Para referencia 001401329.

Referencia	Dimensión	Embalaje
001401330	Ø11x200mm	10/100

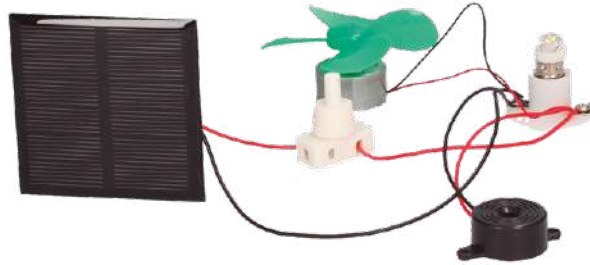

Kit solar eléctrico escolar

Contiene: un portalámparas rosca E10, una bombillas LED 3V-0.5W, un interruptor 250V-2A, un timbre 3V-24V, una placa solar 3V, un motor eléctrico y 2 hélices de plástico. Especial para manualidades.

Referencia	Embalaje
501040001	200



Kit eléctrico escolar

Contiene: portalámparas, bombilla 4V (0.4A), interruptor 250V (2A), batería 4.5V y 1M de cable para conexión. Especial para manualidades.

Referencia	Embalaje
001401694	60

Motor para manualidades

Especial para manualidades.

Referencia	Voltaje	Embalaje
001401648	1.5-3V	30/300





Pack discos de corte de acero inoxidable



Material: **óxido de aluminio**. Ideal para corte de: **hierro y acero inoxidable**.

Referencia	Pack	Diámetro x Espesor x Agujero	Tipo	Centro	Máx. RPM	Embalaje
502002001	10 Ud.	Ø115x1x22.23mm	T41 A46R-BF		13.300	10/40
502002018	25 Ud.	Ø115x1x22.23mm	T41 A46R-BF		13.300	4/16
502002002	10 Ud.	Ø115x1.6x22.23mm	T41 A46R-BF		13.300	5/20
502002019	25 Ud.	Ø115x1.6x22.23mm	T41 A46R-BF		13.300	5/20



Pack 5 discos de desbaste



Material: **óxido de aluminio**. Ideal para desbaste de **metales**.

Referencia	Diámetro x Espesor x Agujero	Tipo	Centro	Máx. RPM	Embalaje
502002003	Ø115x4.8x22.23mm	T27 A24R-BF		13.300	5/20
502002004	Ø180x6x22.23mm	T27 A24R-BF		8500	3



Pack 10 discos de corte de hierro



Material: **óxido de aluminio**. Ideal para corte de **metales ferrosos**.

Referencia	Diámetro x Espesor x Agujero	Tipo	Centro	Máx. RPM	Embalaje
502002005	Ø230x2x22.23mm	T41 A30R-BF		6600	5



Pack 5 discos de corte de hierro



Material: **óxido de aluminio**. Ideal para corte de **metales ferrosos**.

Referencia	Diámetro x Espesor x Agujero	Tipo	Centro	Máx. RPM	Embalaje
502002006	Ø350x3.2x25.4mm	T41 A30R-BF		4350	3



Set 5 muelas para taladro 1/4"



Material: piedras minerales de vástago de acero. Ideal para **desbaste de precisión** sobre materiales varios.

Referencia	Vástago	Piedras	Embalaje
502006001	3mm	5	10/40



Pack 5 discos de lija 115mm



Material: **óxido de aluminio**. Ideal para lijar **maderas y materiales ferrosos**.

Referencia	Tipo/Diámetro x Agujero	Grano	Máx. RPM	Embalaje
502002007	T27 - Ø115x22.23mm	40	13.300	40
502002008	T27 - Ø115x22.23mm	60	13.300	40
502002009	T27 - Ø115x22.23mm	80	13.300	40
502002010	T27 - Ø115x22.23mm	120	13.300	40



Disco de diamante corte en seco y húmedo 115mm



Material: **cuerpo de acero insertos diamantados.**

Corte en seco y húmedo. Ideal para: **porcelanato, mosaicos, cerámica, azulejos...**

Referencia	Diámetro x Agujero	Máx. RPM	Embalaje
502002011	Ø115x 22.23mm	12.800	10/100



Disco de diamante corte en seco 115mm



Corte en seco.

Referencia	Diámetro x Agujero	Máx. RPM	Embalaje
502002013	Ø115x 22.23mm	13.200	10/100



Disco diamante corte en seco segmentado láser 115mm



Material: **cuerpo de acero insertos diamantados.**

Corte en seco segmentado láser. Ideal para **hormigón, ladrillos, azulejos, cerámica,...**

Referencia	Diámetro x Agujero	Máx. RPM	Embalaje
502002012	Ø115x 22.23mm	13.200	10/100



Sierra circular widia 115mm



Material: **widia** (cuerpo de acero y dientes de carburo tungsteno). Para corte de **madera.**

El uso de las de 30 y 48 dientes es para máquinas de pie y banco.

Referencia	Diámetro x Espesor x Agujero	Reducciones	Dientes	Máx. RPM	Embalaje
502002014	Ø115x2.2x22.23mm	-	40	10.000	10/100
502002015	Ø115x2.2x22.23mm	-	24	10.000	10/100
502002016	Ø230x3x25.4mm	20 / 22.23mm	30	5000	5/25
502002017	Ø230x3x25.4mm	20 / 22.23mm	48	5000	5/25



Set 5 sierras de corona 19 / 22 / 25 / 29 / 32mm



Copas **bimetálicas**. Incluye un soporte para sierra de copa con adaptador para diámetros de Ø14 a 30mm. Ideal para: **metal, madera, plástico, pladur**, etc. Incluye maletín.

Referencia	Diámetros	Embalaje
502005001	Ø19/22/25/29/32mm	10



Set 6 sierras de corona 19 / 22 / 32 / 38 / 44 / 57mm



Copas **bimetálicas**. Incluye un soporte para sierra de copa con adaptador para diámetros de Ø14 a 30mm y otro para diámetros de Ø32 a 152mm. Ideal para: **metal, madera, plástico, pladur**, etc. Incluye maletín.

Referencia	Diámetros	Embalaje
502005002	Ø19/22/32/38/44/57mm	10



Set 5 brocas de 4 a 10mm para madera



Material: **acero**. Ideal para: **madera**.

Referencia	Diámetros	Embalaje
502001001	Ø4/5/6/8/10mm	10/50



Set 6 brocas de 2 a 8mm para hierro y acero



Material: **acero rápido HSS**. Ideal para: **hierro y acero**.

Referencia	Diámetros	Embalaje
502001002	Ø2-8mm	10/50



Set 4 brocas para mampostería



Material: **widia**. Enganche **cilíndrico**. Ideal para: **mampostería, pladur...**

Referencia	Dimensión	Embalaje
502001003	Ø5x85mm / Ø6x100mm / Ø8x120mm / Ø10x120mm	5/100



Set 4 brocas para mampostería y concreto



Material: **widia SDS**. Enganche **SDS+**. Ideal para: **hormigón, mampostería, pladur...**

Referencia	Dimensión	Embalaje
502001004	Ø5x110mm / Ø6x110mm / Ø8x160mm / Ø10x160mm	45/90



Cepillo copa de alambre **ondulado**



Material: **alambre de acero ondulado latonado 0.3mm**. Ideal para: **madera, plástico, metales**. Para amoladora. Rosca: **M14**.

Referencia	Diámetro	Máx. RPM	Embalaje
502003009	Ø60mm	12.500	10/100
502003010	Ø75mm	12.500	10/80
502003011	Ø100mm	8500	10/30



Cepillo de alambre **con espiga**



Material: **alambre de acero ondulado latonado 0.3mm**. Ideal para: **madera, plástico, metales**. Vastago 6 mm.

Referencia	Diámetro	Máx. RPM	Embalaje
502003001	Ø12mm	6000	10/200
502003002	Ø17mm	6000	10/200
502003003	Ø26mm	6000	10/200



Cepillo copa de alambre con espiga



Material: **alambre de acero ondulado latonado 0.3mm**. Ideal para: **madera, plástico, metales**. Vastago 6 mm.

Referencia	Diámetro	Máx. RPM	Embalaje
502003007	Ø50mm	4500	10/200
502003008	Ø75mm	4500	10/100



Cepillo de alambre con espiga



Material: **alambre de acero ondulado latonado 0.3mm**. Ideal para: **madera, plástico, metales**. Vastago 6 mm.

Referencia	Diámetro	Máx. RPM	Embalaje
502003004	Ø50mm	7500	10/250
502003005	Ø75mm	4500	10/150
502003006	Ø100mm	4500	10/100

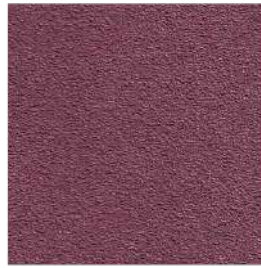

Pack 25 papeles de lija

Material: abrasivo de **óxido de aluminio** sobre respaldo de papel. Ideal para: lijado grueso de **maderas, pinturas y masillas**.
Recomendado para **uso en seco**. Color grano rojo. Dimensión: 230x280mm.

Referencia	Grano	Embalaje
502004001	220	20
502004002	150	20
502004003	120	20
502004004	80	20
502004005	60	20
502004006	40	20



Pack 25 papeles de lija de agua

Material: abrasivo de **carburo de silicio** sobre respaldo de papel. Ideal para: **chapas, muebles de acabados finos**..
Recomendado para **uso en mojado**. Color grano negro. Dimensión: 230x280mm.

Referencia	Grano	Embalaje
502004007	240	20
502004008	280	20
502004009	320	20
502004010	360	20
502004011	400	20
502004012	500	20
502004013	600	20
502004014	1000	20
502004015	1200	20
502004016	2500	20



Pistola de pintura con sistema de gravedad 600cc



Material: **cuerpo aluminio pico y aguja acero inox depósito plástico.** Terminaciones de alta calidad ahorra pintura y preseva el medio ambiente, tranferencia superior al 75% evita el exceso de niebla, regulador de caudal de aire, manual con despiece.

Referencia	Depósito	Pico	Embalaje
503000003	600ml.	1.5mm	20



Recipiente de plástico 600cc



Material: **plástico.** Para pistola de pintura 503000003.

Referencia	Depósito	Embalaje
503000004	600ml.	50



Pinzas conexaso

Indicado para baterías de **cobre**.

Referencia	Sección	Longitud	Amperios	Embalaje
107005001	16mm ²	3M	200A	10
107005002	25mm ²	3.5M	300A	10
107005003	35mm ²	4.5M	400A	10



A



B

Caja organizadora de herramientas

Material: **PP**.

Referencia	Artículo	Pack	Compartimentos	Dimensión	Embalaje
502080004	A	12 Ud.	7	280x200x50mm	12
502080003	B	1 Ud.	22	360x360x50mm	12



Doble fondo para
una mayor organización

Con asa
para transportar
fácilmente



2 cierres
para un buen sellado



Tapa superior
con varios compartimentos

Caja de herramientas

Material: PP. Doble fondo.

Referencia	Capacidad	Dimensión	Embalaje
003300141	11L	410x210x185mm	9
502080001	18L.	490x240x215mm	9



Toldo polietileno

Color azul. Peso: 65g/m². **Ojales metálicos** cada metro. Bordes reforzados con PE.

Referencia	Dimensión	Embalaje
003300124	2x3M	40
003300125	3x5M	16
003300126	4x6M	10
003300127	5x8M	5



Cinta persiana gris

Material: **PE**.

Referencia	Anchura	Color	Longitud	Embalaje
003301345	14mm	Gris	6M	100
003301346	18mm	Gris	6M	100
003301347	20mm	Gris	6M	100



Cincha con metal 25mm 5M

Anclaje de acero. Soporta hasta 1 tonelada. Cuerda 100% poliéster.

Referencia	Longitud	Embalaje
502015000	5M	25



Cincha amarre elástica

Anclaje de acero. Cuerda de goma + PP. Diámetro: Ø8mm.

Referencia	Longitud	Embalaje
003300129	0.8M	50/100
003300130	1M	50/100
003300131	1.2M	50/100
003300132	1.5M	50/100





Candado arco corto de acero

Incluye **2 llaves**. Tipo de arco clásico. Material: **argolla de acero y cuerpo de latón**. Muy resistente en los ambientes salinos.

Referencia	Grosor	Peso	Dimensión	Embalaje
502010003	20mm	32gr.	35x8x20mm	12/280
502010004	25mm	45gr.	40x9x25mm	12/280
502010005	30mm	67gr.	50x10x30mm	12/144
502010006	40mm	85gr.	60x12x40mm	12/144
502010007	50mm	200gr.	75x15x50mm	6/60
502010008	60mm	300gr.	85x18x60mm	6/36



Candado arco largo de acero

Incluye **2 llaves**. Tipo de arco largo. Material: **argolla de acero y cuerpo de latón**. Muy resistente en los ambientes salinos.

Referencia	Grosor	Peso	Dimensión	Embalaje
502010009	40mm	130gr.	100x12x40mm	12/144
502010010	50mm	224gr.	105x15x50mm	12/60



Candado de combinación 3 números

Combinación hasta 3 números.
Material: **aleación de zinc**. Dim.: 55x10x30mm.

Referencia	Grosor	Peso	Embalaje
502010011	30mm	44gr.	10/240



Candado de exterior arco corto de acero

Incluye **2 llaves**. Material: **acero**.
Dim.: 95x35x55mm.

Referencia	Grosor	Peso	Embalaje
502010012	50mm	330gr.	12/48



Candado bicicleta

Con **cierre de seguridad**. Cable en espiral. Incluye 2 llaves.

Referencia	Diámetro	Longitud	Embalaje
502010000	Ø8mm	1M	12/60
502010001	Ø12mm	1M	12/60
502010002	Ø12mm	1.8M	12/60





Gancho multiusos

Peso máximo soportado: **20Kg**. Material: **acero**. Incluye accesorios para su instalación. Ideal para colgar bicicletas y todo aquello que necesites.

Referencia	Embalaje
003301684	24



Gancho pared

Peso máximo soportado: **30Kg**. Material: **acero**. Incluye accesorios para su instalación. Ideal para colgar bicicletas, skys,...

Referencia	Peso soportado	Embalaje
003301686	Máx. 30Kg	5



A

B



C

D

Gavetas polipropileno

Material: PPC. **Apilables.**

Referencia	Artículo	Tipo	Dimensión	Embalaje
003301670	A	S	175x115x75mm	40
003301671	B	M	250x165x125mm	40
003301672	B	Separador M	-	20
003301673	C	L	355x220x150mm	10
003301674	C	Separador L	-	10
003301675	D	XL	515x330x200mm	8
003301676	D	Separador XL	-	10





A



B



C



D

Símbolos adhesivos

Material: **acero inoxidable + PP. Acabado cromado.** Tipo: redondo. Montaje: **adhesivo.**

Referencia	Artículo	Icono	Dimensión	Embalaje
003301396	A	Hombre	Ø97x3mm	50/500
003301397	B	Mujer	Ø97x3mm	50/500
003301398	C	Minusválido	Ø97x3mm	50/500
003301399	D	No fumar	Ø97x3mm	50/500



A

B

C



D

E

F

Letras para calles, puertas, bloques con adhesivo

Material: **acero inoxidable + PP. Níquel satín**. Grosor: 2mm. Montaje: **adhesivo**.

Referencia	Artículo	Icono	Dimensión	Embalaje
003302620	A	A	65x95mm	50/500
003302621	B	B	65x95mm	50/500
003302622	C	C	65x95mm	50/500
003302623	D	D	65x95mm	50/500
003302624	E	E	65x95mm	50/500
003302625	F	F	65x95mm	50/500



A



B



C



D



E



F



G



H



I



J

Números para puertas con tornillo

Material: **acero inoxidable**. Acabado **titanio dorado**. Grosor: 3.5mm. Montaje: **atornillado**.

Referencia	Artículo	Icono	Dimensión	Embalaje
003302600	A	0	85x110mm	50/500
003302601	B	1	85x110mm	50/500
003302602	C	2	85x110mm	50/500
003302603	D	3	85x110mm	50/500
003302604	E	4	85x110mm	50/500
003302605	F	5	85x110mm	50/500
003302606	G	6	85x110mm	50/500
003302607	H	7	85x110mm	50/500
003302608	I	8	85x110mm	50/500
003302609	J	9	85x110mm	50/500

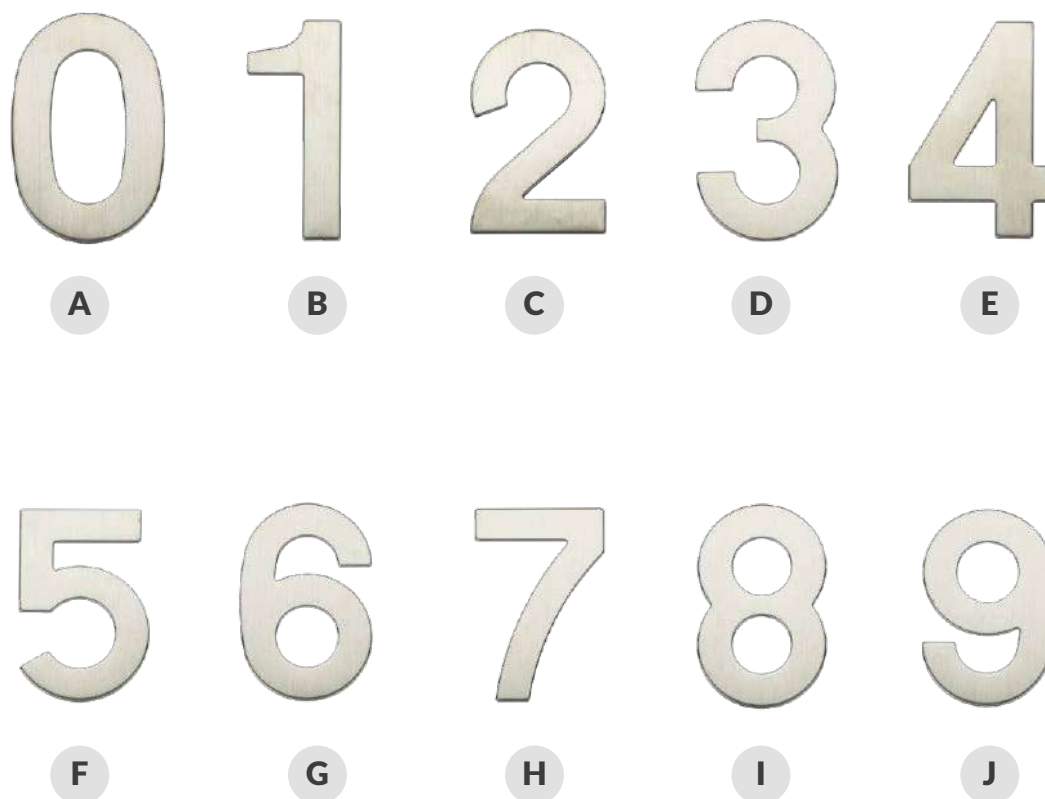

Números para puertas con adhesivo

Material: **acero inoxidable + PP. Níquel satín**. Grosor: 2mm. Montaje: **adhesivo**.

Referencia	Artículo	Icono	Dimensión	Embalaje
003302610	A	0	65x95mm	50/500
003302611	B	1	65x95mm	50/500
003302612	C	2	65x95mm	50/500
003302613	D	3	65x95mm	50/500
003302614	E	4	65x95mm	50/500
003302615	F	5	65x95mm	50/500
003302616	G	6	65x95mm	50/500
003302617	H	7	65x95mm	50/500
003302618	I	8	65x95mm	50/500
003302619	J	9	65x95mm	50/500

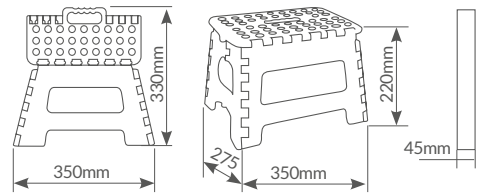
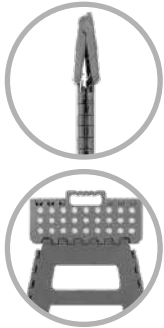

Taburete de plástico

Plegado con un sólo movimiento. Superficie **antideslizante**. Gran estabilidad. Resistente y duradero. Pesa menos de 1Kg. **Con asa** para transportar cómodamente. Fácil almacenaje. Ocupa muy poco espacio. Material: **PP**. Para cocinas, baños, oficinas, como asiento para niños/as, para usar al aire libre...

Referencia	Peso	Embalaje
502050000	Máx. 200Kg	12



Taburete de plástico

Material: **plástico**. Altura: 460mm. Color: **gris**.

Referencia	Peso	Embalaje
502050009	Máx. 200Kg	1



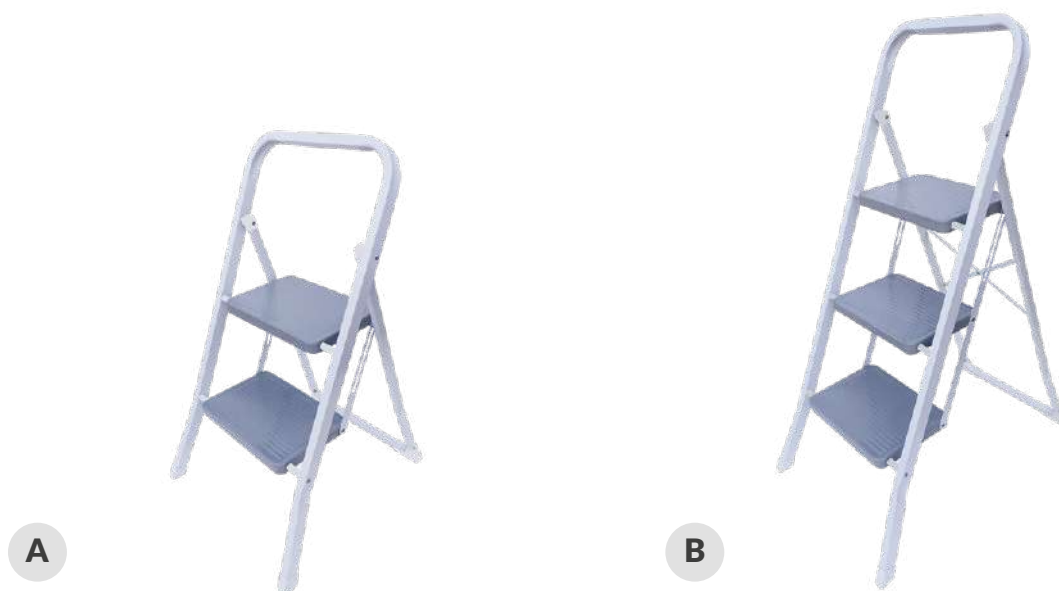

Taburete de acero

Material: **acero**. Peldaño: 200x300mm.

Referencia	Artículo	Peldaños	Peso	Altura plataforma	Dimensión	Embalaje
003502025	A	2	Máx. 150Kg.	480mm	450x500x787mm	6
003502026	B	3	Máx. 150Kg.	720mm	450x675x1024mm	4



Taburete de aluminio 3 peldaños

Material: **aluminio y acero**. Peldaño: 80mm de ancho. Sistema de seguridad. Peldaños **antideslizantes** con relieve. **Plataforma de acero**. Refuerzo posterior con intersección. Testado hasta 260Kg. Resistente y muy ligero.

Referencia	Peldaños	Peso	Dimensión (Abierta)	Embalaje
502050002	3	Máx. 150Kg.	330x266x220mm	1





A



B



C



D



E



F



Escaleras de aluminio

Material: **aluminio**. Peldaño: 80mm de ancho. Sistema de seguridad de **bloqueo exclusivo**. Peldaños **antideslizantes** con relieve. Testado para **10.000 ciclos** y hasta 260Kg. Sólida y ligera.

Referencia	Artículo	Peldaños	Peso	Altura plataforma	Embalaje
502050003	A	3	Máx. 150Kg.	580mm	1
502050004	B	4	Máx. 150Kg.	790mm	1
502050005	C	5	Máx. 150Kg.	1010mm	1
502050006	D	6	Máx. 150Kg.	1230mm	1
502050007	E	7	Máx. 150Kg.	1440mm	1
502050008	F	8	Máx. 150Kg.	1660mm	1

Carretilla

PLEGABLE

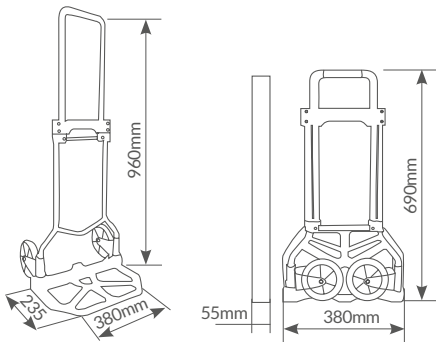

Carretilla plegable con ruedas

Material: **acero inoxidable**. Rueda: Ø135mm.

Referencia	Peso	Embalaje
502050001	Máx. 60Kg	4



Carro
PLATAFORMA

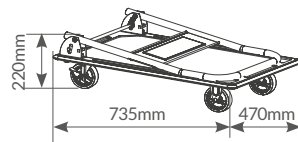
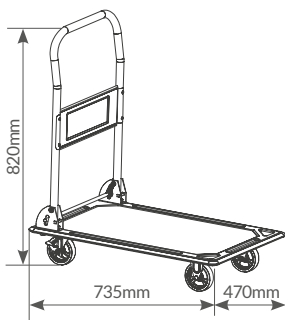

Carro plataforma de transporte plegable con frenos

Material: **acero**. Con 4 ruedas: Ø100mm. Con freno.

Referencia	Peso	Embalaje
502007001	Máx. 150Kg	2
502085008	Rueda recambio fija	
502085009	Rueda recambio freno	





Cinta aislante eléctrica PVC

Excelente adhesión. **Autoextinguible.**
Apta para utilizar en **temperaturas superiores a los 80°C.**

Referencia	Artículo	Color	Ancho	Longitud	Embalaje
004102250	A	○ Blanco	19mm	10M	10/100
004102251	A	● Negro	19mm	10M	10/100
004102255	B	○ Blanco	19mm	20M	10/200
004102256	B	● Negro	19mm	20M	10/200



Cinta aislante eléctrica PVC

Excelente adhesión. **Autoextinguible.**
Apta para utilizar en **temperaturas superiores a los 80°C.**

Referencia	Color	Ancho	Longitud	Embalaje
004102271	○ Blanco	25mm	20M	10/200
004102272	● Negro	25mm	20M	10/200





Cinta americana impermeable

3 capas: impermeable de polietileno, resistente de poliéster y adhesivo elastómero. Especialmente indicada para aplicaciones temporales de **reparación, sujeción, enmascarado, sellado, aislamiento**, etc. Fácilmente rasgable a mano y muy resistente.

Referencia	Color	Ancho	Longitud	Embalaje
004102260	● Negro	50mm	10M	72



Cinta americana impermeable

3 capas: impermeable de polietileno, resistente de poliéster y adhesivo elastómero. Especialmente indicada para aplicaciones temporales de **reparación, sujeción, enmascarado, sellado, aislamiento**, etc. Fácilmente rasgable a mano y muy resistente.

Referencia	Color	Ancho	Longitud	Embalaje
004102261	● Gris	50mm	10M	72



Cinta multiusos de aluminio

Para instalación de **aire acondicionado** y **extractores**.
Temperatura de uso **-20° a +110°C**. Anchura: **50mm**.

Referencia	Color	Longitud	Embalaje
004102262	● Aluminio	10M	72



Cinta de embalar

Anchura: **50mm**.

Referencia	Color	Longitud	Embalaje
004102263	○ Transparente	48M	48
004102265	○ Transparente	132M	48





Cinta impermeable

Anchura: **48mm**. Ideal para el sellado de tuberías, bajantes, grietas, etc.

Referencia	Color	Longitud	Embalaje
004102264	● Negro	30M	48



Cinta doble cara

Anchura: **19mm**. Adhesivo: **holtmelt**. Ideal para la fijación de objetos en baños, lugares húmedos y exteriores. Blíster.

Referencia	Color	Longitud	Embalaje
004102275	○ Blanco	30M	48



Cinta doble cara

Ideal para fijar pequeños electrodomésticos, marcos de foto, accesorios de baño, objetos de decoración, topes de puerta, especieros de cocina, colgadores, etc. En el exterior ideal para fijar buzones, carteles, letreros, números, matrículas, etc.

Referencia	Color	Ancho	Longitud	Embalaje
004102270	○ Blanco	50mm	10M	36



Cinta carrocer

Ideal para pintar.

Referencia	Anchura	Longitud	Embalaje
004102266	19mm	50M	96
004102267	24mm	50M	24
004102268	38mm	50M	36
004102269	50mm	50M	36



Artículos navidad

Navidad y decoración





Funciona con pilas

1.9M

Guirnalda **alambre LED**

Funciona con pilas (no incluidas). IP20.

Referencia	Luz / Color	Longitud	Nº de LEDs	Pila	Embalaje
204805026	● Fría	1.9M	20	2xAA	50



A



B



Funciona con pilas

2M

Guirnalda **alambre LED**

Funciona con pilas (incluidas). **Con temporizador: On 6h. / Off. 18h.** Guirnalda: **IP65**. Compartimento pilas compacto. **IP20**.

Referencia	Artículo	Luz / Color	Longitud	Nº de LEDs	Pila	Embalaje
204805015	A	● Cálida	2M	20	2xCR2032	100
204805016	B	● Fría	2M	20	2xCR2032	100





A

B

C



Funciona con pilas

1.9M

3.9M

Guirnalda alambre LED

Funciona con pilas (no incluidas). Con temporizador: On 6h. / Off. 18h. IP20.

Referencia	Artículo	Luz / Color	Longitud	Nº de LEDs	Pila	Embalaje
204805002	A	● Cálida	1.9M	20	2 x AA	100
204805003	B	● Azul	1.9M	20	2 x AA	100
204805004	A	● Cálida	3.9M	40	3 x AA	100
204805005	C	● Fría	3.9M	40	3 x AA	100



D

E

F



Funciona con pilas

4.9M

Guirnalda alambre LED

Con 8 funciones. Funciona con pilas (no incluidas). Con temporizador: On 6h. / Off. 18h. IP20.

Referencia	Artículo	Luz / Color	Longitud	Nº de LEDs	Pila	Embalaje
204805007	D	● Cálida	4.9M	50	3 x AA	100
204805008	E	● Fría	4.9M	50	3 x AA	100
204805009	F	● RGB	4.9M	50	3 x AA	100



Funciona a corriente

5M 10M

Guirnalda alambre LED

8 funciones. Funciona a 220-240V. Con temporizador: On 6h./Off. 18h. IP44.

Referencia	Artículo	Luz / Color	Longitud	Nº de LEDs	Embalaje
204805027	A	● Cálida	4.9M	50	24
204805028	B	● Fría	4.9M	50	24
204805029	C	● Cálida	9.9M	100	48

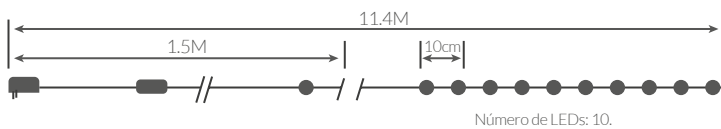

Funciona a corriente

9.9M

Guirnalda alambre LED

8 funciones. Funciona a 220-240V. Con temporizador: On 6h./Off. 18h. IP44.

Referencia	Luz / Color	Longitud	Nº de LEDs	Embalaje
204805010	● Fría	9.9M	100	25

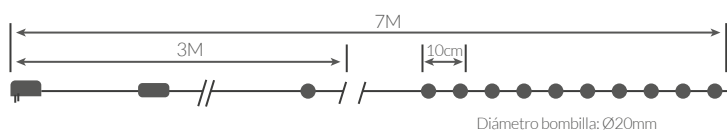

Guirnalda LED de bombillas

8 funciones. Funciona a 220-240V. Con temporizador: On 6h. / Off. 18h. IP44.

Referencia	Luz / Color	Longitud	Nº de LEDs	Embalaje
204600014	RGB	4M	40	20

Navidad Guirnalda



A



B

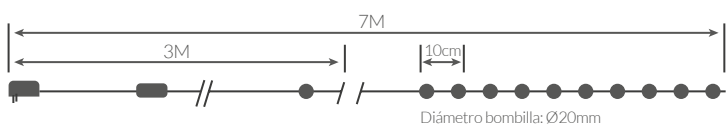

Guirnalda LED de bombillas

8 funciones. Funciona a 220-240V. IP44.

Referencia	Artículo	Luz	Longitud	Nº de LEDs	Embalaje
204600030	A	● Cálida	4M	40	24
204600031	B	● Fría	4M	40	24



A



B

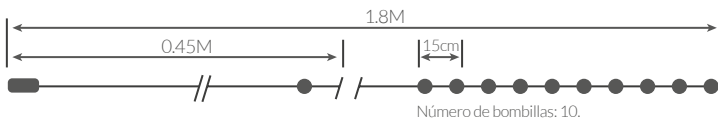

Guirnalda LED de bombillas

Funciona con 2 pilas AA (no incluidas). Con temporizador: On 6h. / Off. 18h. IP20.

Referencia	Artículo	Luz	Color	Longitud	Nº de LEDs	Embalaje
204805020	A	● Cálida	● Doradas	1.35M	10	10
204805021	B	● Fría	● Plateadas	1.35M	10	10

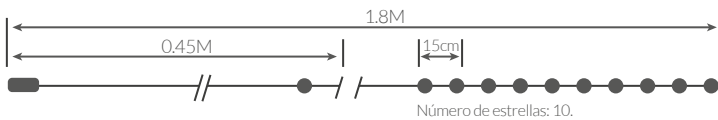

Estrellas LED multicolor

Funciona con 2 pilas AA (no incluidas). Con temporizador: On 6h. / Off. 18h. IP20.

Referencia	Luz	Color	Longitud	Nº de LEDs	Embalaje
204600027	● Cálida	Rojo / Dorado / Verde	1.35M	10	10



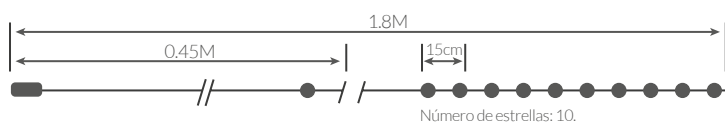

Estrellas LED de madera

Funciona con 2 pilas AA (no incluidas). **Con temporizador: On 6h. / Off. 18h.** IP20.

Referencia	Luz	Color	Longitud	Nº de LEDs	Embalaje
204600025	● Cálida	● Blanco / Madera	1.35M	10	10

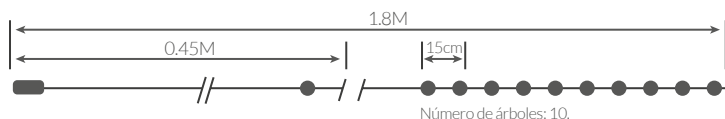
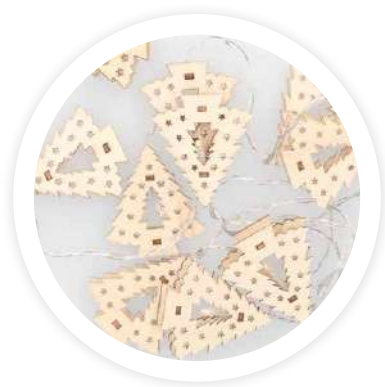

Árboles LED de madera

Funciona con 2 pilas AA (no incluidas). **Con temporizador: On 6h. / Off. 18h.** IP20.

Referencia	Luz	Color	Longitud	Nº de LEDs	Embalaje
204600023	● Cálida	● Madera	1.35M	10	10
204600024	● Fría	● Madera	1.35M	10	10

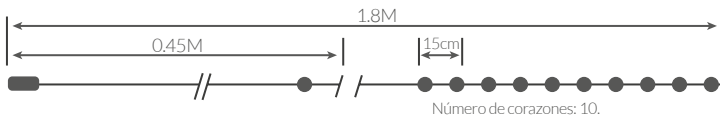

Corazones LED de madera

Funciona con 2 pilas AA (no incluidas). **Con temporizador: On 6h. / Off. 18h.** IP20.

Referencia	Luz	Color	Longitud	Nº de LEDs	Embalaje
204600000	● 2700-3000K	○ Blanco	1.35M	10	24

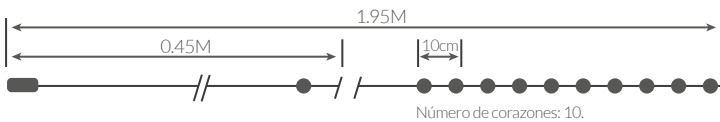

Corazones LED plateados

Funciona con 2 pilas AA (no incluidas). IP20.

Referencia	Modelo	Luz	Color	Longitud	Nº de LEDs	Embalaje
005204472	Corazones	● 6000-10000K	● Plateadas	1.5M	10	20



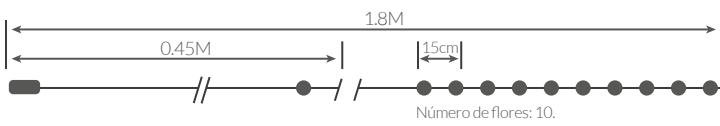

Flores LED transparentes

Funciona con 2 pilas AA (no incluidas). **Con temporizador: On 6h. / Off. 18h.** IP20.

Referencia	Luz	Color	Longitud	Nº de LEDs	Embalaje
204805011	● Fría	○ Transparente	1.35M	10	10

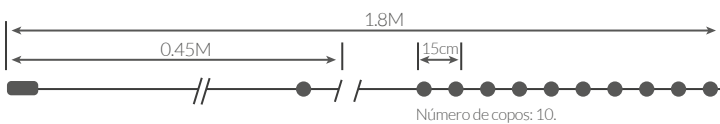

Copos de nieve LED transparentes

Funciona con 2 pilas AA (no incluidas). **Con temporizador: On 6h. / Off. 18h.** IP20.

Referencia	Luz	Color	Longitud	Nº de LEDs	Embalaje
204600026	● Fría	○ Transparente	1.35M	10	10

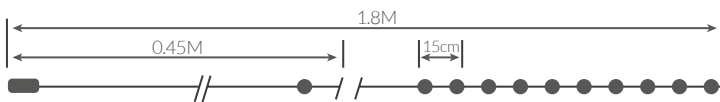

Pinzas LED transparentes

Funciona con 2 pilas AA (no incluidas). **Con temporizador: On 6h. / Off. 18h.** IP20.

Referencia	Luz	Color	Longitud	Nº de LEDs	Embalaje
204805031	● Fría	○ Transparente	1.35M	10	24

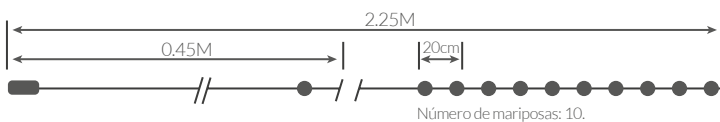

Mariposas LED blancas

Funciona con 2 pilas AA (no incluidas). **Con temporizador: On 6h. / Off. 18h.** IP20.

Referencia	Luz	Color	Longitud	Nº de LEDs	Embalaje
204805012	● Cálida	○ Blanco	1.8M	10	10

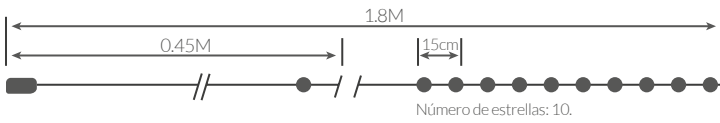

Estrellas LED doradas

Funciona con 2 pilas AA (no incluidas). **Con temporizador: On 6h. / Off. 18h.** IP20.

Referencia	Luz	Color	Longitud	Nº de LEDs	Embalaje
204805001	● Cálida	● Doradas	1.35M	10	10

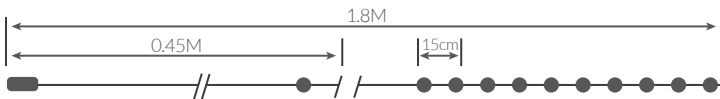

Estrellas LED doradas

Funciona con 2 pilas AA (no incluidas). **Con temporizador: On 6h. / Off. 18h.** IP20.

Referencia	Luz	Color	Longitud	Nº de LEDs	Embalaje
204600007	● 2700-3000K	● Doradas	1.35M	10	24

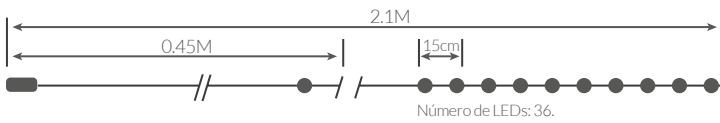

Muérdago LED rojo

Funciona con 2 pilas AA (no incluidas). **Con temporizador: On 6h. / Off. 18h.** IP20.

Referencia	Luz	Color	Longitud	Nº de LEDs	Embalaje
204600028	● Roja	● Rojo / Verde	1.65M	36	10

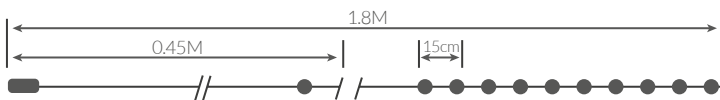

Guirnalda LED de bolas de madera

Funciona con 2 pilas AA (no incluidas). **Con temporizador: On 6h. / Off. 18h.** IP20.

Referencia	Luz	Color	Longitud	Nº de LEDs	Embalaje
204805030	● Cálida	● Beige	1.35M	10	24



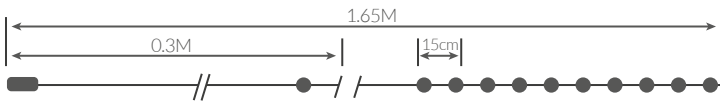

Muñecos de nieve LED

Funciona con 2 pilas AA (no incluidas). **Con temporizador: On 6h. / Off. 18h.** IP20.

Referencia	Luz	Color	Longitud	Nº de LEDs	Embalaje
204690015	● Cálida	○ Blanco	1.35M	10	24

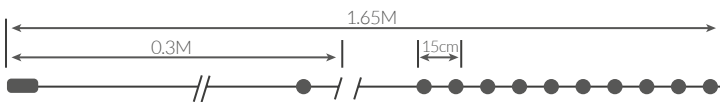

Calcetines LED

Funciona con 2 pilas AA (no incluidas). **Con temporizador: On 6h. / Off. 18h.** IP20.

Referencia	Luz	Color	Longitud	Nº de LEDs	Embalaje
204690016	● Cálida	● Rojo/Blanco	1.35M	10	24

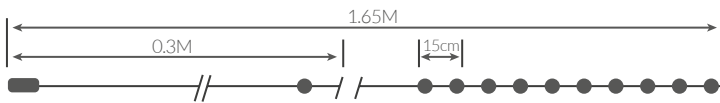

Papá Noel LED

Funciona con 2 pilas AA (no incluidas). **Con temporizador: On 6h. / Off. 18h.** IP20.

Referencia	Luz	Color	Longitud	Nº de LEDs	Embalaje
204690017	● Cálida	● Rojo/ Blanco	1.35M	10	24

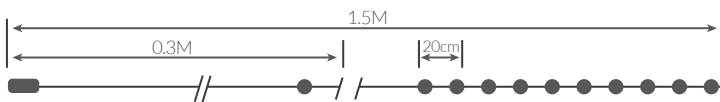

Bastones de caramelo LED

Funciona con 2 pilas AA (no incluidas). **Con temporizador: On 6h. / Off. 18h.** IP20.

Referencia	Luz	Color	Longitud	Nº de LEDs	Embalaje
204690018	● Cálida	● Rojo/ Blanco	1.2M	28	24



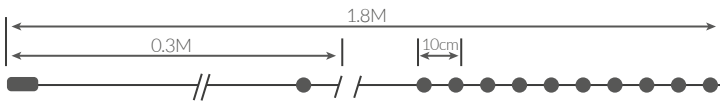

Guirnalda LED de ramas y bayas rojas

Funciona con 2 pilas AA (no incluidas). Con temporizador: On 6h. / Off. 18h. IP20.

Referencia	Luz	Longitud	Nº de LEDs	Embalaje
204690021	● Cálida	1.5M	50	12

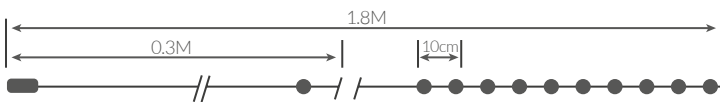

Guirnalda LED de hojas de arce y bellotas

Funciona con 2 pilas AA (no incluidas). Con temporizador: On 6h. / Off. 18h. IP20.

Referencia	Luz	Longitud	Nº de LEDs	Embalaje
204690023	● Cálida	1.5M	15	24

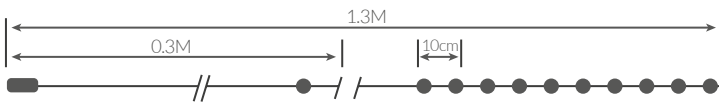

Guirnalda LED de piñas

Funciona con 2 pilas AA (no incluidas). **Con temporizador: On 6h. / Off. 18h.** IP20.

Referencia	Luz	Longitud	Nº de LEDs	Embalaje
204690024	● Cálida	1M	12	12

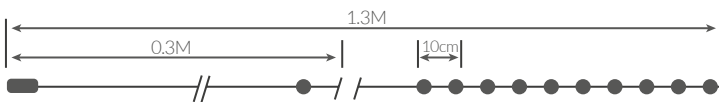

Guirnalda LED de bellotas

Funciona con 2 pilas AA (no incluidas). **Con temporizador: On 6h. / Off. 18h.** IP20.

Referencia	Luz	Longitud	Nº de LEDs	Embalaje
204690025	● Cálida	1M	15	12



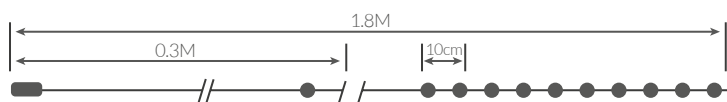

Guirnalda LED de hojas de acebo blanco y bayas

Funciona con 2 pilas AA (no incluidas). Con temporizador: On 6h. / Off. 18h. IP20.

Referencia	Luz	Longitud	Nº de LEDs	Embalaje
204690028	● Cálida	1.5M	16	12

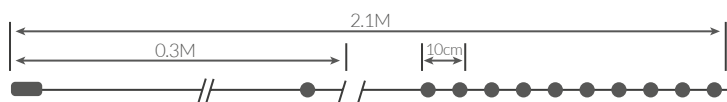

Guirnalda LED de bayas rojas

Funciona con 2 pilas AA (no incluidas). Con temporizador: On 6h. / Off. 18h. IP20.

Referencia	Luz	Longitud	Nº de LEDs	Embalaje
204690029	● Cálida	1.8M	20	12

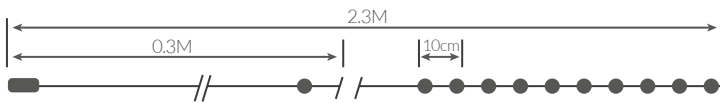

Guirnalda LED de hojas, piñas y bayas rojas

Funciona con 2 pilas AA (no incluidas). **Con temporizador: On 6h. / Off. 18h.** IP20.

Referencia	Luz	Longitud	Nº de LEDs	Embalaje
204690030	● Cálida	2M	20	12

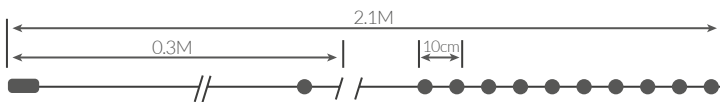

Guirnalda LED estrellas, piñas y bayas rojas

Funciona con 2 pilas AA (no incluidas). **Con temporizador: On 6h. / Off. 18h.** IP20.

Referencia	Luz	Longitud	Nº de LEDs	Embalaje
204690032	● Cálida	1.8M	20	12



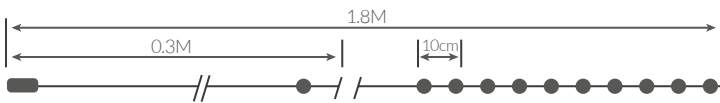

Guirnalda LED de piñas y bayas rojas

Funciona con 2 pilas AA (no incluidas). Con temporizador: On 6h. / Off. 18h. IP20.

Referencia	Luz	Longitud	Nº de LEDs	Embalaje
204690033	● Cálida	1.5M	35	12

Navidad Guirnaldas

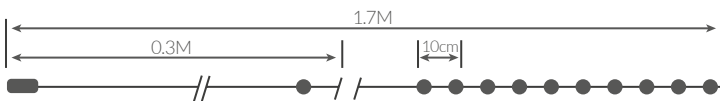

Guirnalda LED de ramas de pino y piñas

Funciona con 2 pilas AA (no incluidas). Con temporizador: On 6h. / Off. 18h. IP20.

Referencia	Luz	Longitud	Nº de LEDs	Embalaje
204690035	● Cálida	1.4M	15	8

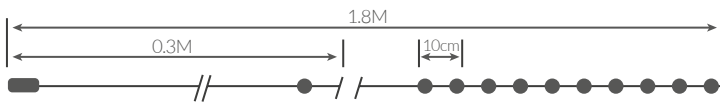

Guirnalda LED de perlas rojas

Funciona con 3 pilas AA (no incluidas). **Con temporizador: On 6h. / Off. 18h.** IP20.

Referencia	Luz	Longitud	Nº de LEDs	Embalaje
204690039	● Cálida	1.5M	80	24



Guirnalda LED de hojas doradas

Funciona con 3 pilas AA (no incluidas). **Con temporizador: On 6h. / Off. 18h.** IP20.

Referencia	Luz	Longitud	Nº de LEDs	Embalaje
204690040	● Cálida	1.5M	100	24



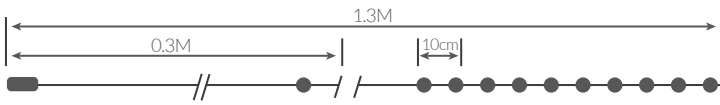

Guirnalda LED de estrellas, piñas y árboles

Funciona con 2 pilas AA (no incluidas). **Con temporizador: On 6h. / Off. 18h.** IP20.

Referencia	Luz	Longitud	Nº de LEDs	Embalaje
204690036	● Cálida	1M	10	12

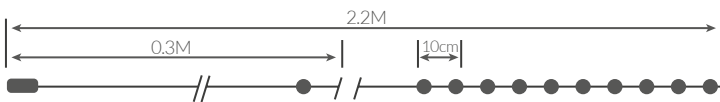

Guirnalda LED de cuerda

Funciona con 2 pilas AA (no incluidas). **Con temporizador: On 6h. / Off. 18h.** IP20.

Referencia	Luz	Longitud	Nº de LEDs	Embalaje
204690037	● Cálida	1.9M	20	48

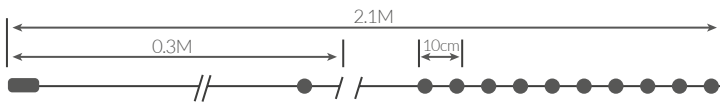

Guirnalda LED de cuerda y piñas

Funciona con 3 pilas AA (no incluidas). **Con temporizador: On 6h. / Off. 18h.** IP20.

Referencia	Luz	Longitud	Nº de LEDs	Embalaje
204690042	● Cálida	1.8M	120	24

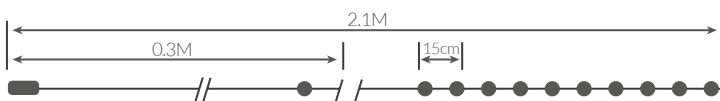



Guirnalda LED de mini perlas rojas

Funciona con 2 pilas AA (no incluidas). **Con temporizador: On 6h. / Off. 18h.** IP20.

Referencia	Luz	Longitud	Nº de LEDs	Embalaje
204690044	● Cálida	1.8M	36	30





 Cambia de color al ritmo de la música 



Mando con 24 funciones



Intensidad regulable



Sensor de sonido rítmico



Función memoria

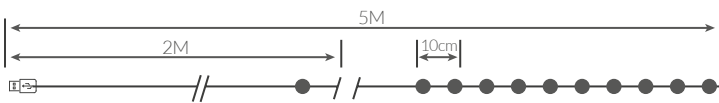

Guirnalda bolas LED RGB con USB + mando

24 funciones. Cable USB: 2M. 5-7V. Con temporizador: On 6h. / Off. 18h. Guirnalda: IP44. USB: IP20.

Referencia	Potencia	Color	Longitud	Nº de LEDs	Embalaje
204805013	5-10W	RGB	3M	30	50



FUNCIONA CON LA APP IDEAL

CONTROLA TUS DISPOSITIVOS DESDE TU SMARTPHONE

Smarty

GUIRNALDA LED



 Cambia de color al ritmo de la música 



CONTROLA TODOS TUS DISPOSITIVOS DESDE TU SMARTPHONE
Compatible con smartphones a partir de la versión Android 4.4 & IOS 8.0

SMARTY
WORLD

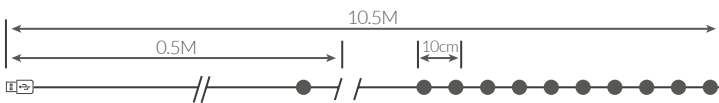

Guirnalda LED inteligente con USB + mando RGB

24 funciones. Cable USB: 0.5M. Con **sensor rítmico**: cambia al ritmo de la música.
Con temporizador: On 4-6-8h. / Off. 20-18-16h. Guirnalda: **IP65.** USB: **IP20.** 5-7V.

Referencia	Potencia	Color	Longitud	Nº de LEDs	Embalaje
204805014	5-10W	RGB	10M	100	50



FUNCIONA CON LA APP SMARTLIFE

DISFRUTA DE UN HOGAR INTELIGENTE



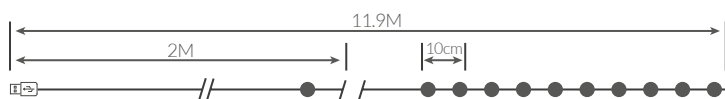

Guirnalda alambre LED con USB + mando RGB

32 funciones. Cable USB: 2M. 5V. Con temporizador: On 4-6-8h. / Off. 20-18-16h. IP20.

Referencia	Potencia	Color	Longitud	Nº de LEDs	Embalaje
204600029	6W	RGB	9.9M	100	40

Navidad Guirnalda

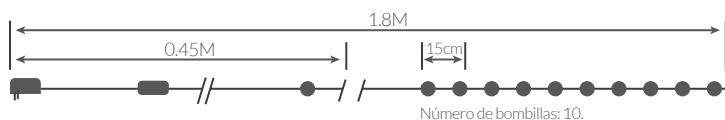

Guirnalda LED bolas de algodón

Funciona con 2 pilas AA (no incluidas). Con temporizador: On 6h. / Off. 18h. IP20.

Referencia	Luz	Color	Longitud	Nº de LEDs	Embalaje
204805018	● Cálida	● Rosa	1.35M	10	10
204805019	● Cálida	● Azul	1.35M	10	10

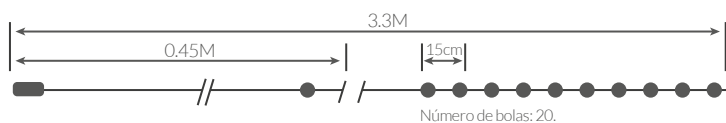

Guirnalda LED **bolas multicolor de algodón**

Funciona con 3 pilas AAA (no incluidas). **Con temporizador: On 6h. / Off. 18h.** IP20.

Referencia	Luz	Color	Longitud	Nº de LEDs	Embalaje
204805017	● Cálida	Rojo / Azul / Verde / Amarillo	2.85M	20	5

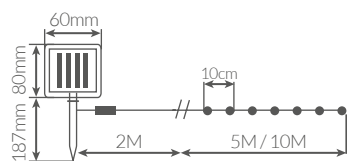

5M **10M**

Guirnalda LED **solar**

8 funciones. Autonomía: máx. 8h. Incluye estaca.

Con temporizador: On 6h. / Off. 18h. Batería litio 500mAh / 3.7V. Panel solar 100mA / 5V. **IP44.**

Referencia	Luz	Longitud	Nº de LEDs	Embalaje
204640001	● Cálida	5M	50	20
204640002	● Fría	5M	50	20
204640003	● Cálida	10M	100	20
204640004	● Fría	10M	100	20



A



B



Funciona
a corriente

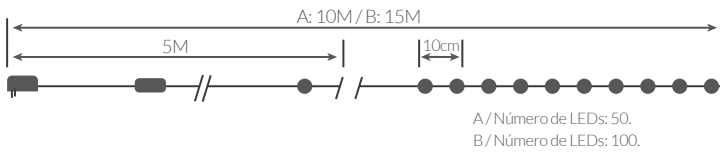

5M

10M

Guirnalda LED transparente

8 funciones. Funciona a 220-240V. **Con temporizador: On 6h. / Off. 18h. IP44.**

Referencia	Artículo	Luz	Color	Longitud	Nº de LEDs	Embalaje
204600017	A	● Cálida	○ Transparente	5M	50	20
204600018	B	● Fría	○ Transparente	5M	50	20
204600019	A	● Cálida	○ Transparente	10M	100	20
204600020	B	● Fría	○ Transparente	10M	100	20



A



B



C



Funciona
a corriente

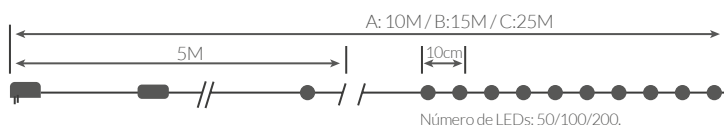

5M

10M

20M

Guirnalda LED

8 funciones. Cable: verde. Con temporizador: On 6h. / Off. 18h. Funciona a 220-240V. IP44.

Referencia	Artículo	Luz	Longitud	Nº de LEDs	Embalaje
204600010	A	● Cálida	5M	50	20
204600040 ★	A	● Cálida	5M	500	12
204600011	B	● Fría	5M	50	20
204600042 ★	B	● Fría	5M	500	20
204600015	C	● RGB	5M	50	20
204600012	A	● Cálida	10M	100	20
204600041 ★	A	● Cálida	10M	1000	8
204600013	B	● Fría	10M	100	20
204600043 ★	B	● Fría	10M	1000	8
204600016	C	● RGB	10M	100	20
204600035	A	● Cálida	20M	200	24
204600036	B	● Fría	20M	200	24
204600037	C	● RGB	20M	200	24



A



B



C



D



E



F

Ramas decorativas LED

Funciona con 2 pilas AA (no incluidas). **Con temporizador: On 6h. / Off. 18h.** IP20.

Referencia	Artículo	Modelo	Luz	Altura	Nº de LEDs	Embalaje
204690002	A	Hojas de pino, piñas y bayas rojas	● Cálida	75cm	24	12
204690003	B	Hojas y bayas blancas	● Cálida	75cm	16	24
204690005	C	Hojas de arce doradas	● Cálida	70cm	16	24
204690006	D	Hojas de arce blancas	● Cálida	70cm	25	24
204690007	E	Bayas rojas	● Cálida	75cm	20	24
204690008	F	Bayas rojas	● Cálida	80cm	20	12



A



B



C



D



E

Ramas decorativas LED

Funciona con 2 pilas AA 3V (no incluidas). **Con temporizador: On 6h. / Off. 18h.** IP20.

Referencia	Artículo	Modelo	Luz	Altura	Nº de LEDs	Embalaje
204690009	A	Hojas de eucalipto rosas	● Cálida	83cm	16	24
204690011	B	Hojas palmito doradas	● Cálida	75cm	20	24
204690012	C	Dientes de león dorados	● Cálida	75cm	20	12
204690013	D	Piñas y bayas rojas	● Cálida	75cm	16	24
204690014	E	Flores de algodón y bayas blancas	● Cálida	55cm	10	24

Bartel GNOMO

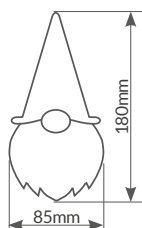

Gnomo de navidad **sentado Krampus**

Display 12 unidades.

Material: **poliéster**. Con colgador. Uso interior.

Referencia

Luz

Embalaje

204690095

● Rojo/Blanco/Gris

12/72

Krampus GNOMO

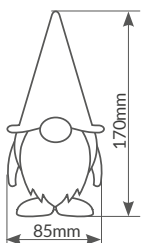

Gnomo de navidad **sentado Krampus**

Display 12 unidades.

Material: **poliéster**. Uso interior.

Referencia

Luz

Embalaje

204690096

● Rojo/Verde

12/72



Rubbels

GNOMO

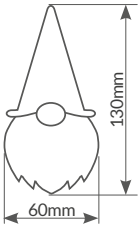

Gnomo de navidad **sentado Krampus**

Display 12 unidades.
Material: **poliéster**. Uso interior.

Referencia

Luz

Embalaje

204690097

● Rojo / Gris

12/72

Belén

NACIMIENTO



Figura nacimiento **belén**

Display 12 unidades.
Material: **cerámica**. Uso interior.

Referencia

Color

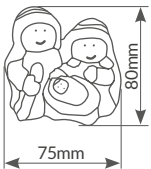
Embalaje

204690098

● Rojo/Blanco

12/96



Beira

MUÑECO NIEVE



Muñeco de nieve **Beira**

Material: **poliéster**. Uso interior.

Referencia	Color	Embalaje
204690087	● Rojo/Blanco	24

Navidad Gnomos

Eira

MUÑECO NIEVE

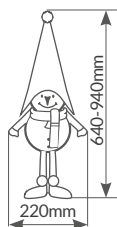

Muñeco de nieve **Eira**

Material: **poliéster**. Uso interior.

Referencia	Color	Embalaje
204690089	● Rojo/Blanco	12

Gelbin

GNOMO

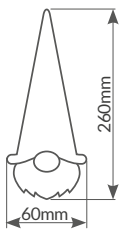
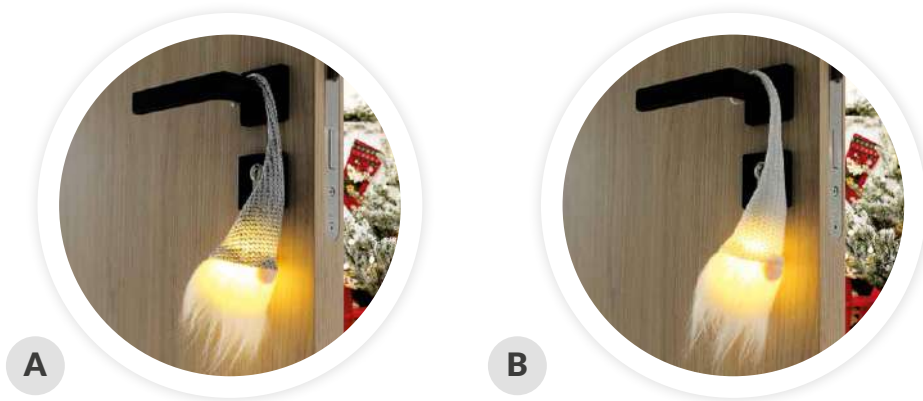

Navidad Gnomos

Gnomo de navidad LED colgante Gelbin

Display 12 unidades.

Se ilumina el cuerpo. Funciona con 2 pilas LR44 1.5V (incluidas). Uso interior. IP20.

Referencia	Artículo	Potencia	Luz	Color	Nº de LEDs	Embalaje
204690104	A	0.06W	● Cálida	● Gris	1	12/144
204690105	B	0.06W	● Cálida	○ Blanco	1	12/144

Sicco
GNOMO

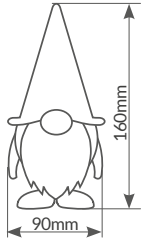

Gnomo de navidad LED de pie Sicco

Display 12 unidades.

Se **ilumina el cuerpo**. Funciona con 2 pilas LR44 1.5V (incluidas). Uso interior. IP20.

Referencia	Potencia	Luz	Color	Nº de LEDs	Embalaje
204690107	0.06W	● Cálida	● Rojo/Blanco	1	12/72

Nefti
GNOMO

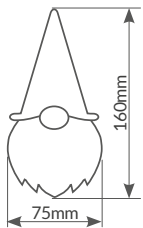

Gnomo de navidad LED Nefti

Display 12 unidades.

Se **ilumina el cuerpo**. Funciona con 2 pilas LR44 1.5V (incluidas). Uso interior. IP20.

Referencia	Potencia	Luz	Color	Nº de LEDs	Embalaje
204690109	0.06W	● Cálida	● Rojo/Blanco	1	12/72

Kazbo GNOMO

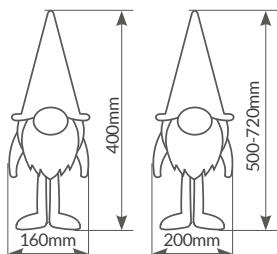

Gnomo de navidad LED de pie Kazbo

Se ilumina la nariz. Funciona con 2 pilas CR2032 3V (incluidas).
Con temporizador: **On 6h. / Off. 18h.** Uso interior. IP20.

Referencia	Potencia	Luz	Tamaño	Nº de LEDs	Embalaje
204690110	0.21W	● Cálida	Mini	1	48
204690112	0.21W	● Cálida	Large	1	48

Hagin GNOMO

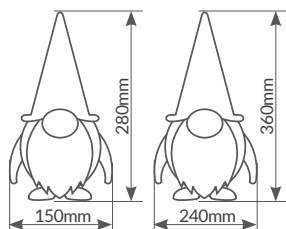

Gnomo de navidad LED sentado Hagin

Se ilumina la nariz. Funciona con 2 pilas CR2032 3V (incluidas).
Con temporizador: **On 6h. / Off. 18h.** Uso interior. IP20.

Referencia	Potencia	Luz	Tamaño	Nº de LEDs	Embalaje
204690113	0.21W	● Cálida	Mini	1	24
204690114	0.21W	● Cálida	Large	1	24



Dremth

GNOMO

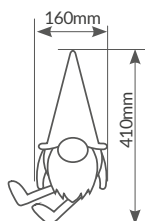

Gnomo de navidad LED con piernas colgantes Dremth

Se **ilumina la nariz**. Funciona con 2 pilas CR2032 3V (incluidas).
Con temporizador: On 6h./ Off. 18h. Uso interior. IP20.

Referencia	Potencia	Luz	Nº de LEDs	Embalaje
204690116	0.21W	● Cálida	1	48

Frostine

PÁJARO



Pájaro de navidad LED Frostine

Se **ilumina el cuerpo**. Funciona con 2 pilas LR44 1.5V (incluidas). Uso interior. IP20.

Referencia	Potencia	Luz	Nº de LEDs	Embalaje
204690094	0.06W	● Cálida	1	24



Ariel

ÁNGEL

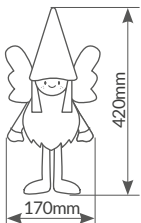

Ángel LED de pie Ariel

Se **ilumina el cuerpo**. Funciona con 2 pilas LR44 1.5V (incluidas). Uso interior. IP20.

Referencia	Potencia	Luz	Nº de LEDs	Embalaje
204690090	0.15W	● Cálida	1	24

Haniel

ÁNGEL

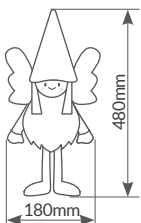

Ángel LED piernas colgantes Haniel

Se **ilumina el cuerpo**. Funciona con 2 pilas LR44 1.5V (incluidas). Uso interior. IP20.

Referencia	Potencia	Luz	Nº de LEDs	Embalaje
204690092	0.15W	● Cálida	1	24

Alasia

ESTRELLA

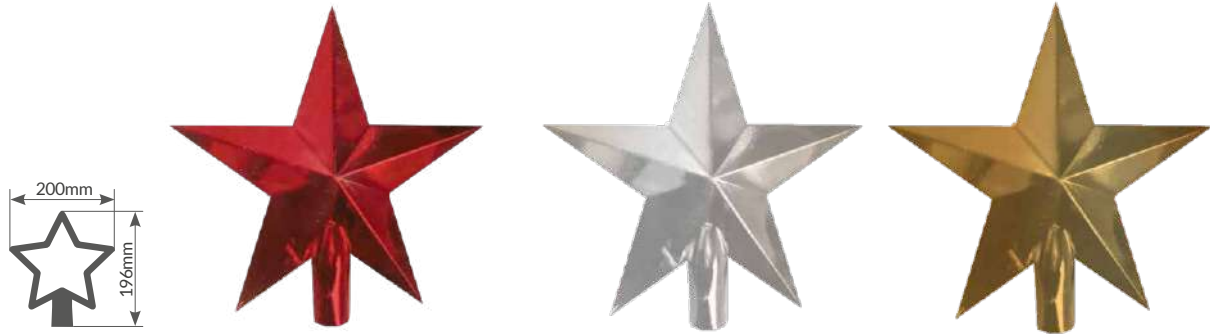

Estrella de navidad árbol **Alasia**

Material: plástico. Acabado: **brillo**. Uso interior.

Referencia	Color	Embalaje
204635014	● Rojo	48
204635015	● Plateado	48
204635016	● Dorado	48



Estrella de ratán **LED**

Funciona con 2 pilas AA 3V (No incluidas).
Con temporizador: On 6h. / Off. 18h. Uso interior. IP20.

Referencia	Potencia	Luz	Nº de LEDs	Embalaje
204690068	0.75W	● Cálida	50	12



Papa Noël



Árbol



Galleta



Caramelo

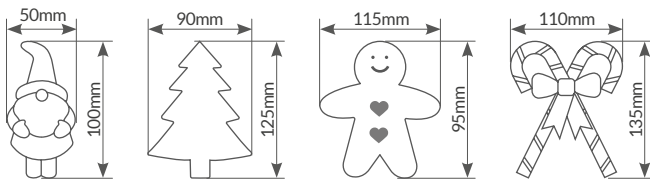

Decoración árbol de **navidad colgante**

Material: arcilla polimérica. Acabado: **mate**. Uso interior.

Referencia	Artículo	Color	Embalaje
204635023	Papa Noël	● Rojo/Blanco	12/144
204635024	Árbol navidad	● Verde	12/144
204635025	Galleta hombre decorativa	● Marrón/Blanco	12/144
204635026	Bastones caramelo	● Rojo/Blanco	12/144

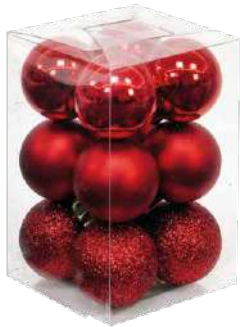

Pack 12 Unid.



Pack 8 Unid.



Pack 6 Unid.



Pack 6 Unid.

Bolas de navidad

Material: plástico. Acabado: **brillo**. Uso interior.

Referencia	Pack	Diámetro	Acabado	Color	Embalaje
204635001	12 Unid.	Ø60mm	Brillo / Mate / Purpurina	● Rojo	36
204635002	12 Unid.	Ø60mm	Brillo / Mate / Purpurina	● Plateado	36
204635003	12 Unid.	Ø60mm	Brillo / Mate / Purpurina	● Dorado	36
204635004	8 Unid.	Ø60mm	Brillo	● Rojo	72
204635005	8 Unid.	Ø60mm	Brillo	● Plateado	72
204635006	8 Unid.	Ø60mm	Brillo	● Dorado	72
204635007	6 Unid.	Ø80mm	Brillo / Mate / Purpurina	● Rojo	36
204635008	6 Unid.	Ø80mm	Brillo / Mate / Purpurina	● Plateado	36
204635009	6 Unid.	Ø80mm	Brillo / Mate / Purpurina	● Dorado	36
204635010	6 Unid.	Ø80mm	Brillo	● Rojo	24
204635011	6 Unid.	Ø80mm	Brillo	● Plateado	24
204635012	6 Unid.	Ø80mm	Brillo	● Dorado	24

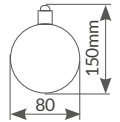

Bola de navidad LED

Material: plástico. Funciona con 3 pilas LR44 3V (Incluidas).
Botón: On / Off. Uso interior. IP20.

Referencia	Pack	Diámetro	Luz	Embalaje
204635017	12 Unid.	Ø80mm	● Cálida	12/72

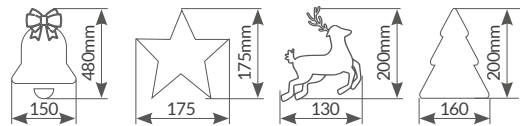

Decoración colgante de navidad LED

Material: plástico. Funciona con 3 pilas AAA 3V (No incluidas).
Ideal para **colocar en ventanas**. Botón: On / Off. **Con colgador adhesivo**. Uso interior. IP20.

Referencia	Artículo	Luz	Embalaje
204635018	Campana	● Cálida	24
204635019	Estrella	● Cálida	24
204635020	Reno	● Cálida	24
204635021	Árbol	● Cálida	24

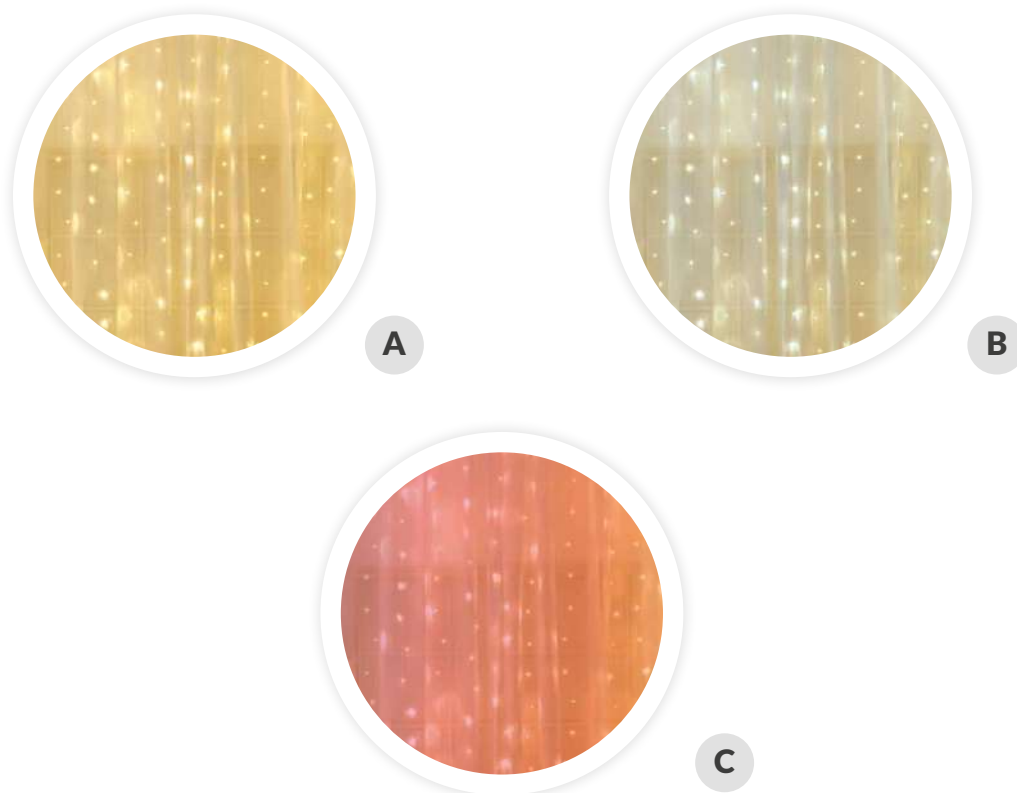

* Consulta el esquema en el apartado info técnica.

Cortina LED luminosa

8 funciones. Incluye 3M de cable. **Con temporizador: On 6h. / Off. 18h.** Funciona a 220-240V. IP44.

Referencia	Artículo	Potencia	Nº colgadores	Luz	Ancho x Alto	Nº de LEDs	Embalaje
204605002	A	0.9W	5	● Cálida	1 x 1.2M	60	10
204605001	B	0.9W	5	● Fría	1 x 1.2M	60	10
204605004	A	3.6W	10	● Cálida	2 x 1M	100	10
204605003	B	3.6W	10	● Fría	2 x 1M	100	10
204605006	A	3.6W	10	● Cálida	2 x 2M	200	10
204605005	B	3.6W	10	● Fría	2 x 2M	200	10
204605007	C	3.6W	10	● RGB	2 x 2M	200	10
204605009	A	3.6W	30	● Cálida	3 x 1M	300	10
204605008	B	3.6W	30	● Fría	3 x 1M	300	10
204605011	A	6W	16	● Cálida	3 x 2M	320	10
204605010	B	6W	16	● Fría	3 x 2M	320	10
204605018★	A	3.6W	20	● Cálida	5 x 1M	200	12
204605019★	B	3.6W	20	● Fría	5 x 1M	200	12

204695001 Recambio de colgadores para cortinas LED luminosas para referencias 204605001 - 02 - 03 - 04 - 05 - 06 - 07 - 08 - 09 - 10 - 11 - 18 - 19

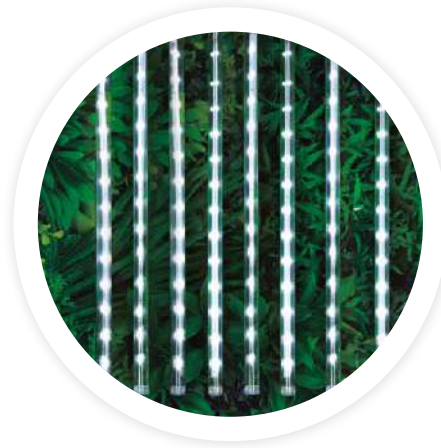

Cortina LED efecto lluvia meteoros

Con temporizador: On 6h. / Off. 18h. 3M de cable. IP44.

Referencia	Potencia	Luz	Longitud x Altura	Nº de Tubos	Embalaje
204605028	3W	● Fría	3M x 0.3M	15	12
204605029	4W	● Fría	5M x 0.3M	20	12



Cortina LED con bolas

8 funciones. Incluye 8 colgadores adhesivos y 3M de cable.
Con temporizador: On 6h. / Off. 18h. IP20. 5V.

Referencia	Potencia	Luz	Longitud	Nº de LEDs	Embalaje
204605024	6W	● Cálida	1.4M	92	8

* Consulta el esquema en el apartado info técnica.



* Consulta el esquema en el apartado info técnica.

Cortina LED con estrellas

8 funciones. Incluye 24 colgadores adhesivos y 3M de cable.
Con temporizador: On 6h. / Off. 18h. IP20. 5V.

Referencia	Potencia	Luz	Longitud	Nº de LEDs	Embalaje
204605025	6W	● Fría	2.3M	120	24



* Consulta el esquema en el apartado info técnica.

Cortina LED con campanas y muñecos de nieve

8 funciones. Incluye 8 colgadores adhesivos y 3M de cable.
Con temporizador: On 6h. / Off. 18h. IP20. 5V.

Referencia	Potencia	Luz	Longitud	Nº de LEDs	Embalaje
204605026	6W	● Cálida	1.4M	132	12



* Consulta el esquema en el apartado info técnica.

Cortina LED con estrellas y copos de nieve

8 funciones. Incluye 12 colgadores adhesivos y 3M de cable.
Con temporizador: On 6h. / Off. 18h. Cortina: **IP44.** USB: **IP20.** 5-7V.

Referencia	Potencia	Luz	Longitud	Nº de LEDs	Embalaje
204605012	5-10W	● Fría	3.5M	138	30



* Consulta el esquema en el apartado info técnica.

Cortina LED con estrellas

8 funciones. Incluye 12 colgadores adhesivos y 3M de cable.
Con temporizador: On 6h. / Off. 18h. Cortina: **IP44.** USB: **IP20.** 5-7V.

Referencia	Potencia	Luz	Longitud	Nº de LEDs	Embalaje
204605013	5-10W	● Cálida	3.5M	138	30



A

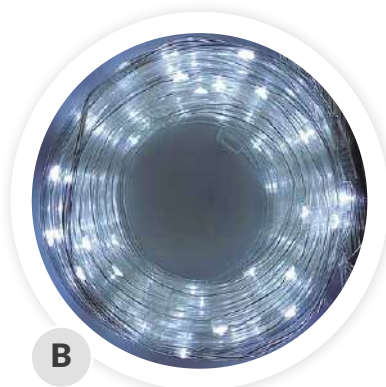

B



C

Kit 4M tubo LED flexible

8 funciones. Preparado para conectar. Incluye: 1.5M de cable.
Con temporizador: On 6h./ Off. 18h. Funciona a 220-240V. **IP44.**

Referencia	Artículo	Potencia	Luz	Longitud	Nº de LEDs	Embalaje
204690073	A	1.35W	● Cálida	4M	80	24
204690074	B	1.35W	● Fría	4M	80	24
204690075	C	1.35W	● RGB	4M	80	24



Kit 5M tubo LED flexible bastón de caramelo

8 funciones. Preparado para conectar. Incluye conector y adaptadores.
Con temporizador: On 6h./ Off. 18h. Funciona a 220-240V. **IP44.**

Referencia	Potencia	Luz	Longitud	Nº de LEDs	Embalaje
204610012	2.8W	● Cálida	5M	120	24



Tubos

FIJOS



A



B



C



D



Rollo 48M tubo LED flexible

Tipo: **fijo**. Corte cada metro. **Conexión máximo de 48M**.
Funciona a 220-240V. **IP44**.

Referencia	Artículo	Potencia	Luz	Longitud	Nº de LEDs	Embalaje
204610001	A	Máx. 81.6W	● Cálida	48M	36LEDs/M	1
204610002	B	Máx. 81.6W	● Fría	48M	36LEDs/M	1
204610003	C	Máx. 81.6W	● Amarillo	48M	36LEDs/M	1
204610004	D	Máx. 81.6W	● RGB	48M	36LEDs/M	1

Tubos

8 FUNCIONES



A



B



C

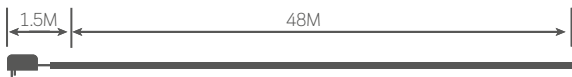

Rollo 48M tubo LED flexible 8 funciones

Tipo: **8 funciones**. Corte cada metro. **Conexionado máximo de 48M**.
Funciona a 220-240V. **IP44**.

Referencia	Artículo	Potencia	Luz	Longitud	Nº de LEDs	Embalaje
204610008	A	Máx. 81.6W	● Cálida	48M	36LEDs/M	1
204610009	B	Máx. 81.6W	● Fría	48M	36LEDs/M	1
204610010	C	Máx. 81.6W	● RGB	48M	36LEDs/M	1



Accesorios tubos flexibles

Para tubo LED luminoso flexible.

Referencia	Artículo	Tipo	Vías	Pack	Embalaje
005204446	A	Clip de sujeción	2 y 3	10Ud.	5
005204448	B	Terminal de protección	-	10Ud.	5
204610005	C	Kit conector tubo flexible Para ref 204610001-02-03-04	2	1	50
204610011	C	Kit conector tubo flexible Para ref 204610008-09-10	3	1	50

Mubi
CORONA



Corona de navidad Mubi

Artificial.

Referencia	Diámetro	Color	Nº de ramas	Embalaje
204690136	Ø50cm	● Verde	80	12





Kiak
CORONA



Corona de navidad nevada Kiak

Artificial.

Referencia	Diámetro	Color	Nº de ramas	Embalaje
204625003	Ø50cm	● Verde	80	6

Navidad Tubos LED

Baliti
CORONA



Corona de navidad efecto nieve con acebo y piñas Baliti

Artificial.

Referencia	Diámetro	Color	Nº de ramas	Embalaje
204625001	Ø50cm	● Verde	80	6

Zerga
GUIRNALDA



Guirnalda navidad Zerga

Artificial.

Referencia	Longitud	Color	Nº de ramas	Embalaje
204690137	0.9M	● Verde	75	48
204690138	1.2M	● Verde	90	36
204690139	1.5M	● Verde	100	24
204690140	1.8M	● Verde	120	24

Babai
GUIRNALDA



Guirnalda navada Babai

Artificial.

Referencia	Longitud	Color	Nº de ramas	Embalaje
204625004	1.5M	● Verde	100	12
204625005	1.8M	● Verde	120	12





Dusia

GUIRNALDA



Guirnalda efecto nieve con acebo y piñas Dusia

Artificial.

Referencia	Longitud	Color	Nº de ramas	Embalaje
204625002	1.5M	● Verde	100	12
204625007	1.8M	● Verde	120	12

Navidad Árboles

Adon

ÁRBOL ARTIFICIAL



Árbol de navidad Adon

Artificial. Material: PE.

Referencia	Altura	Diámetro	Embalaje
204620008	40cm	Ø20cm	24

Silat

ÁRBOL ARTIFICIAL



Árbol de navidad **Silat**

Artificial. Material: PE.

Referencia	Altura	Diámetro	Embalaje
204620003	40cm	Ø20cm	24

Gatel

ÁRBOL ARTIFICIAL



Árbol de navidad **Gatel**

Artificial. Material: PE.

Referencia	Altura	Diámetro	Embalaje
204620005	40cm	Ø20cm	24





Padas

ÁRBOL ARTIFICIAL



Árbol de navidad **Padas**

Artificial. Material: PE.

Referencia	Altura	Diámetro	Embalaje
204620010	40cm	Ø20cm	24

Navidad Árboles

Limbai

ÁRBOL ARTIFICIAL



Árbol de navidad **Limbai**

Artificial. Material: PE.

Referencia	Altura	Diámetro	Embalaje
204620007	40cm	Ø20cm	24

Kelo

ÁRBOL ARTIFICIAL



Árbol de navidad Kelo

Artificial. Material: PE.

Referencia	Altura	Diámetro	Embalaje
204620024	50cm	Ø30cm	20

Ponak

ÁRBOL ARTIFICIAL



Árbol de navidad Ponak

Artificial. Material: PE. Luz cálida. Utiliza 3 pilas AA (No incl.). IP20.

Referencia	Altura	Nº de LEDs	Nº de ramas	Diámetro	Embalaje
204620025	60cm	20	75	Ø35cm	10



Kelo

ÁRBOL ARTIFICIAL



Árbol de navidad artificial Kelo

Artificial. Tronco desmontable para guardarlo fácilmente.

Referencia	Altura	Diámetro	Color	Nº de ramas	Embalaje
204690125	1.2M	Ø70cm	● Verde	220	1
204690126	1.5M	Ø85cm	● Verde	400	1
204690127	1.8M	Ø100cm	● Verde	670	1
204690128	2.1M	Ø120cm	● Verde	1000	1
204620018	1.5M	Ø85cm	○ Blanco	400	1
204620019	1.8M	Ø100cm	○ Blanco	670	1
204620020	1.5M	Ø85cm	● Rosa	400	1
204620021	1.8M	Ø100cm	● Rosa	670	1

Lemper
ÁRBOL ARTIFICIAL



Árbol de navidad artificial nevado Lemper

Artificial. Tronco desmontable para guardarlo fácilmente.

Referencia	Altura	Diámetro	Color	Nº de ramas	Embalaje
204620014	1.2M	Ø70cm	● Verde	300	1
204620015	1.5M	Ø85cm	● Verde	480	1
204620016	1.8M	Ø100cm	● Verde	720	1
204620017	2.1M	Ø120cm	● Verde	988	1

Paring

ÁRBOL ARTIFICIAL



Navidad Árboles



Árbol de navidad **aguja de pino Paring**

Artificial. Tipo: **aguja de pino.** Tronco desmontable para guardarlo fácilmente.

Referencia	Altura	Diámetro	Color	Nº de ramas	Embalaje
204620022	1.5M	Ø85cm	● Verde	130	1
204620023	1.8M	Ø120cm	● Verde	240	1



Bousso

ÁRBOL ARTIFICIAL



Árbol de navidad artificial tipo lápiz Bousso

Artificial. Tipo: **lápiz**. Tronco desmontable para guardarlo fácilmente.

Referencia	Altura	Diámetro	Color	Nº de ramas	Embalaje
204690129	1.2M	Ø40cm	● Verde	220	1
204690130	1.5M	Ø50cm	● Verde	360	1
204690131	1.8M	Ø60cm	● Verde	580	1
204690132	2.1M	Ø70cm	● Verde	750	1

Haur

ÁRBOL ARTIFICIAL



Navidad Árboles

Árbol de navidad **artificial efecto nieve con acebo y piñas Haur**

Artificial. Tipo: **efecto nieve con acebo y piñas.** Tronco desmontable para guardarlo fácilmente.

Referencia	Altura	Diámetro	Color	Nº de ramas	Embalaje
204620012	1.5M	Ø65cm	● Verde	326	1
204620013	1.8M	Ø70cm	● Verde	326	1

Niah

ÁRBOL CON LUCES



Móntalo
en sólo 2mín.



Plegado



Árbol de navidad plegable decorado con luces Niah

Artificial. Tipo: **plegable. 8 funciones.** Luz cálida.
Con temporizador: On 6h. / Off. 18h. Fácil de montar y guardar.

Referencia	Altura	Diámetro	Color	Nº de LED	Embalaje
204620001	1.5M	Ø65cm	● Verde	100	1
204620002	1.8M	Ø75cm	● Verde	150	1

Cumia

ÁRBOL DECORATIVO



Navidad Árboles

Árbol decorativo LED Cumia

Tipo: **decorativo**. Con temporizador: **On 6h. / Off. 18h.**

Ramas **plegables** para un fácil almacenaje. **Luz cálida**. Tipo de LEDs: micro LEDs. IP20.

Referencia	Artículo	Altura	Pilas (No incl.)	Color	Nº de LEDs	Nº de Ramas	Embalaje
204690141	A	30cm	2xAA	● Negro	15	5	12
204690142	A	30cm	2xAA	○ Blanco	15	5	12
204690144	A	30cm	2xAA	● Dorado	15	5	12
204690145	B	40cm	3xAA	● Negro	32	8	12
204690146	B	40cm	3xAA	○ Blanco	32	8	12
204690148	B	40cm	3xAA	● Dorado	32	8	12
204690149	C	60cm	3xAA	● Negro	48	6	12
204690150	C	60cm	3xAA	○ Blanco	48	6	12
204690152	C	60cm	3xAA	● Dorado	48	6	12

Sirka

ÁRBOL DECORATIVO



Árbol decorativo LED Sirka

Tipo: **decorativo**. Con temporizador: **On 6h. / Off. 18h.**

Ramas **plegables** para un fácil almacenaje. **Luz cálida**. Tipo de LEDs: micro LEDs. Incluye **cable de 5M**. 220-240V / 24V.

Referencia	Potencia	Altura	Color	Nº de LEDs	Nº de Ramas	Embalaje
204690153	6W	1.2M	● Negro	500	10	6
204690154	6W	1.2M	○ Blanco	500	10	6
204690155	6W	1.2M	● Dorado	500	10	6
204690156	9W	1.5M	● Negro	900	19	6
204690157	9W	1.5M	○ Blanco	900	19	6

Isoka

ÁRBOL DECORATIVO



Navidad Árboles

Árbol LED 8 funciones + mando

8 funciones. Cable USB: 2M. Con temporizador: On 6h. / Off. 18h.
Guirnalda: IP44. USB: IP20. 5V/2A. Incluye cable de 2M. Base: Ø530mm.

Referencia	Potencia	Altura	Color	Nº de LEDs	Nº de tiras	Embalaje
204690078	4W	1.2M	● Cálida	118	12	10
204690081	5W	1.5M	● Cálida	205	15	10

Kiondo

ÁRBOL INTELIGENTE



 Cambia de color al ritmo de la música 



Mando con
24 funciones



Intensidad
regulable



Sensor de
sonido rítmico



Función
memoria

Árbol LED inteligente vía bluetooth + mando

24 funciones. Cable USB: **2M.** Con temporizador: On 6h. / Off. 18h.
Guirnalda: **IP44.** USB: **IP20.** 5V/2A.

Referencia	Potencia	Altura	Color	Nº de LEDs	Nº de tiras	Embalaje
204690080	5W	1.2M	RGB	118	12	10
204690083	6.5W	1.5M	RGB	205	15	10



FUNCIONA CON
LA APP IDEAL

CONTROLA TUS DISPOSITIVOS DESDE TU SMARTPHONE



Hode

ÁRBOL INTELIGENTE



Navidad Árboles

 Cambia de color al ritmo de la música 



Mando con 24 funciones



Intensidad regulable



Sensor de sonido rítmico



Función memoria

Árbol LED 1.5M inteligente vía bluetooth + mando

24 funciones. Incluye 1.9M de cable. Funciona vía **bluetooth**.
 Con temporizador: **On 4-6-8h. / Off. 20-18-16h.** Guirnalda: **IP44.** USB: **IP20.** 5-7V.

Referencia	Potencia	Luz	Altura	Nº de LEDs	Embalaje
204600022	3.6W	 RGB	1.5M	81	6



FUNCIONA CON LA APP IDEAL

CONTROLA TUS DISPOSITIVOS DESDE TU SMARTPHONE

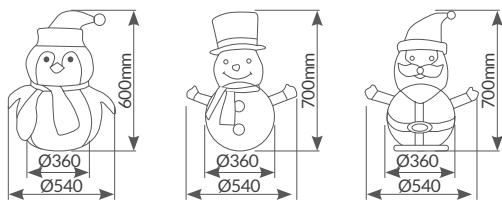

Muñecos LED plegables

8 funciones. Incluye 30cm de cable. **Con temporizador: On 6h. / Off. 18h. Plegable,** fácil almacenaje. Funciona con 3 pilas AA (no incluidas). **Incluye 3 estacas** para colocar en jardín. Uso interior y exterior. **IP44.**

Referencia	Artículo	Modelo	Potencia	Luz	Altura	Nº de LEDs	Embalaje
204690045	A	Pingüino	2W	● Cálida	600mm	40	6
204690046	A	Pingüino	2W	● Fría	600mm	40	6
204690047	B	Papá Noel	2W	● Cálida	700mm	40	6
204690048	B	Papá Noel	2W	● Fría	700mm	40	6
204690049	C	Muñeco nieve	2W	● Cálida	700mm	50	8
204690050	C	Muñeco nieve	2W	● Fría	700mm	50	8



Velas decorativas

Navidad y decoración





Display vela LED decorativa de cera

Display **6 unidades**. Material: **cera**. **Efecto llama**. Funciona a pilas, incluidas.

Referencia	Pilas	Dimensión	Embalaje
204800002	1 x CR2032	Ø50x70mm	6



Pack 3 velas LED decorativas de cera

Efecto llama. Material: **cera**. Diámetro: Ø75mm.
Funciona a pilas, no incluidas.

Referencia	Pilas	Tamaños	Embalaje
204800001	2 x AA	100/ 120/ 150mm	6



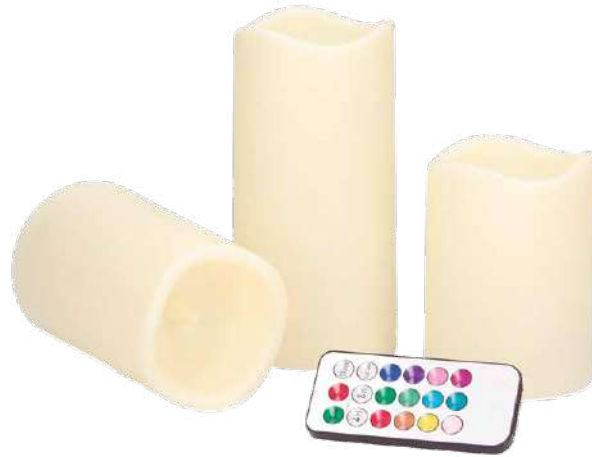

Pack 3 velas LED **decorativas de cera RGB**

Efecto llama. Material: **plástico.** Diámetro: Ø75mm.
Hasta **12 cambios de color.** Funciona a pilas, no incluidas.

Referencia	Pilas	Tamaños	Embalaje
204800005	3xAAA	100 / 120 / 150mm	6



Pack 3 velas LED **decorativas de cera**

Efecto llama. Material: **plástico.**
Diámetro: Ø75mm. Funciona a pilas, no incluidas.

Referencia	Pilas	Tamaños	Embalaje
204800007	2xAA	100 / 120 / 150mm	6



Pack 6 velas decorativas LED

Efecto llama. Funciona a pilas, incluidas.

Referencia	Pilas	Dimensión	Embalaje
204800003	1 x CR2032	Ø36x46mm	108



Pack 6 velas decorativas LED candelabro

Efecto llama. Funciona a pilas, no incluidas.

Referencia	Pilas	Dimensión	Embalaje
204800004	2 x AA	Ø20x160mm	96

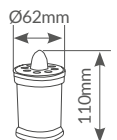

Vela luminosa decorativa LED

Perfecta sustituta de las velas tradicionales. Lúmenes: 5Lm. Botón: On/Off. Funciona a pilas, incluidas.

Referencia	Color	Pilas	Dimensión	Embalaje
204800006	● Rojo	2 x AA (Incl.)	Ø62x120mm	250



Pilas y baterías

Primeras marcas





A



B



C



D



E



F

Pilas salinas GSC Evolution

Pilas GSC Evolution de cloruro de zinc.

Referencia	Artículo	Tecnología	Tipo	Blíster	Embalaje
106000021 ★	A	Salina	R03/AAA	4 unidades	10/180
106000022 ★	B	Salina	R6/AA	4 unidades	10/180
106000023 ★	C	Salina	R14/C	2 unidades	6/144
106000024 ★	D	Salina	R20/D	2 unidades	6/72
106000025 ★	E	Salina	6F22/9V	1 unidad	12/144
009000170	F	Salina	3R12/4.5V	1 unidad	12/144



A



B



C



D

Pilas alcalinas EcoPlus GSC Evolution

Pilas GSC Evolution de **alta calidad** y **duración**.

Referencia	Artículo	Tecnología	Tipo	Blíster	Embalaje
106000052	A	EcoPlus Alcalina	LR03 / AAA	4+2 unidades	10/60
106000053	B	EcoPlus Alcalina	LR6 / AA	4+2 unidades	10/60
106000054	C	EcoPlus Alcalina	LR03 / AAA	8+2 unidades	10/30
106000055	D	EcoPlus Alcalina	LR6 / AA	8+2 unidades	10/30



A



B



C



D



E



F



G

Pilas alcalinas GSC Evolution

Pilas GSC Evolution de **alta calidad** y **duración**.

Referencia	Artículo	Tecnología	Tipo	Blíster	Embalaje
106000026 ★	A	Alcalina	LR03 / AAA	2 unidades	10/180
009000171	B	Alcalina	LR03 / AAA	4 unidades	10/180
106000027 ★	C	Alcalina	LR6 / AA	2 unidades	10/180
009000172	D	Alcalina	LR6 / AA	4 unidades	10/180
009000173	E	Alcalina	LR14 / C	2 unidades	6/144
009000174	F	Alcalina	LR20 / D	2 unidades	6/72
009000175	G	Alcalina	6LR61 / 9V	1 unidad	12/144





A



B

Pilas recargables GSC Evolution

Pilas GSC Evolution de **alta calidad** y **duración**.

Referencia	Artículo	Tecnología	Tipo	Capacidad	Blíster	Embalaje
106005006	A	Recargable	HR03 / AAA	Ni/MH 800mAh	2 unidades	10/100
106005007	B	Recargable	HR6 / AA	Ni/MH 2300mAh	2 unidades	10/100



Pilas recargables GSC Evolution

Pilas GSC Evolution de **alta calidad** y **duración**.

Referencia	Tecnología	Tipo	Capacidad	Blíster	Embalaje
009000187	Litio	18650	Li-Ion 2200mAh 3.7V	2 unidades	100



Cargador pilas recargables GSC Evolution

Pilas GSC Evolution ultrarrápido.

Referencia	Para cargar pilas	Pilas que carga	Embalaje
009000188	18650	2	100



Cargador pilas recargables GSC Evolution

Pilas GSC Evolution ultrarrápido.

Referencia	Para cargar pilas	Pilas que carga	Embalaje
106005011	AAA / AA / 9V	4	60





A



B



C

Pilas litio GSC Evolution

Pilas GSC Evolution litio. Tipo: botón. Pre-cortadas para su venta final de forma individual.

Referencia	Artículo	Tipo	Blfster	Embalaje
106000010	A	CR2016 / 3V	5 unidades	20/200
106000011	B	CR2025 / 3V	5 unidades	20/200
106000012	C	CR2032 / 3V	5 unidades	20/200

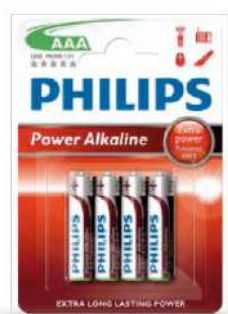

A

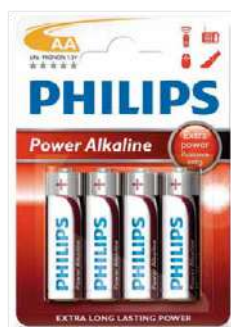

B

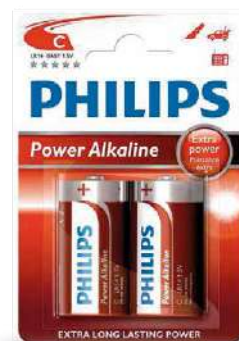

C

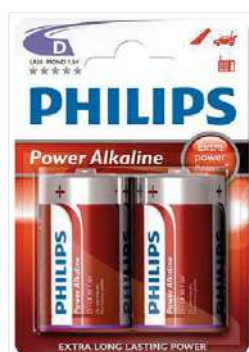

D

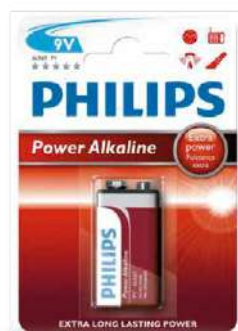

E

Pilas alcalinas Philips

Pilas Philips alcalinas.

Referencia	Artículo	Tipo	Blíster	Embalaje
009000311	A	LR03/AAA	4 unidades	24
009000312	B	LR6/AA	4 unidades	12/36
009000313	C	LR14/C	2 unidades	12/24
009000314	D	LR20/D	2 unidades	12/24
009000315	E	6LF22/9V	1 unidad	24



Pilas litio Philips

Pilas Philips litio. Tipo: botón. Pre-cortadas para su venta final de forma individual.

Referencia	Artículo	Tipo	Blíster	Embalaje
106000018	A	CR2016 / 3V	5 unidades	20/240
106000019	B	CR2025 / 3V	5 unidades	20/240
106000020	C	CR2032 / 3V	5 unidades	20/240



Pilas alcalinas GP

Pilas GP alcalinas.

Referencia	Artículo	Tipo	Blíster	Embalaje
009000406	D	23A / 12V	5 unidades	20/200
009000176	E	27A / 12V	5 unidades	20/200



A

B

C



D



E



F



G

Pilas litio Maxell

Pilas Maxell litio. tipo: botón.

Referencia	Artículo	Tipo	Blíster	Embalaje
106000030	A	CR2016 / 3V	5 unidades	20/400
106000031	B	CR2025 / 3V	5 unidades	20/400
106000032	C	CR2032 / 3V	5 unidades	20/400
106000044	D	LR41 / 1.5V	10 unidades	20/400
106000045	E	LR43 / 1.5V	10 unidades	20/400
106000046	F	LR44 / 1.5V	10 unidades	20/400
106000047	G	LR1130 / 1.5V	10 unidades	20/400



A



B

Pilas recargables GP

Pilas GP recargables. Caja 2 unidades.

Referencia	Artículo	Tipo	Capacidad	Embalaje
106005008	A	HR03 / AAA	1000mAh	10/100
106005009	B	HR6 / AA	2600mAh	10/100

Pilas GP



Cargadores pilas recargables GP

Caja. Incluye 4 pilas recargables AA. **Cargador USB. Ultrarrápido.**

Referencia	Para cargar pilas	Pilas que carga	Capacidad	Embalaje
106005010	AA / AAA	4	2000mAh	6/12



A



B



C



D



E



F

Pilas alcalinas plus Duracell

Pilas alcalinas.

Referencia	Artículo	Tipo	Blíster	Embalaje
009000111	A	LR03 / AAA	4 unidades	10/30
009000112	B	LR6 / AA	4 unidades	20/60
009000103	C	LR14 / C	2 unidades	10/30
009000104	D	LR20 / D	2 unidades	10/30
009000105	E	6LR61 / 9V	1 unidad	10/30
009000115	F	3R12 / 4.5V	1 unidad	10/30





A



B



C



D



E



F

Pilas Duracell

Pilas Duracell mini.

Referencia	Artículo	Tecnología	Tipo	Blíster	Embalaje
009000142	A	Litio	M3 / 123	1 unidad	10/100
009000143	B	Litio	M3 / CR2	1 unidad	10/50
009000140	C	Alcalina	MN21 / 3LR50	2 unidades	10/100
009000144	D	Alcalina	N / LR1	2 unidades	10/100
009000145	E	Alcalina	M3 / AAAA	2 unidades	10/120
009000141	F	Alcalina	MN27	1 unidad	10

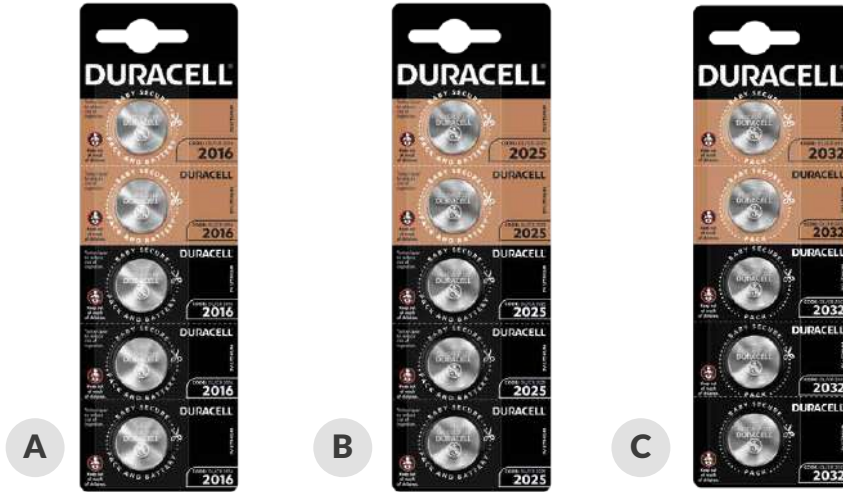

Blister 5 pilas botón litio Duracell

Pilas de litio. Tipo: botón. Pre-cortadas para su venta final de forma individual.

Referencia	Artículo	Tipo	Blister	Embalaje
106000033 ★	A	CR2016	5 unidades	4/40
106000034 ★	B	CR2025	5 unidades	4/40
106000017	C	CR2032	5 unidades	4/40



Pilas audífono Duracell

Pilas Duracell especiales para audífonos.

Referencia	Artículo	Tipo	Blister	Embalaje
106000040	D	DA 10	6 unidades	10/100
106000041	E	DA 13	6 unidades	10/100
106000042	F	DA 312	6 unidades	10/100
106000043	G	DA 675	6 unidades	10/100



A



B



C



D



E



F



G

Pilas reloj Duracell

Pilas Duracell especiales para reloj. Pilas Duracell especiales para reloj. Tecnología: óxido de plata.

Referencia	Artículo	Tipo	Blíster	Embalaje
106000035 ★	A	303/357 (SR44)	2 unidades	10/50
009000154	B	364 (SR621)	1 unidad	10/100
106000036 ★	C	370/371 (SR69)	1 unidad	10/100
009000155	D	376/377 (SR626)	1 unidad	10/100
106000037 ★	E	384/392 (SR41)	1 unidad	10/100
106000038 ★	F	389 (SR54)	1 unidad	10/100
106000039 ★	G	394 (SR45)	1 unidad	10/100



A



B



C



D



E



F



G

Pilas Duracell

Pilas Duracell tipo botón.

Referencia	Artículo	Tecnología	Tipo	Blíster	Embalaje
009000153	A	Óxido de plata	LR44	2 unidades	100
009000146	B	Litio	DL1220	1 unidad	10
009000162	C	Litio	DL1616	1 unidad	10
009000147	D	Litio	DL1620	1 unidad	10
106000001	E	Litio	DL1632	1 unidad	10
009000151	F	Litio	DL2430	1 unidad	10
009000152	G	Litio	DL2450	1 unidad	10/100





A



B

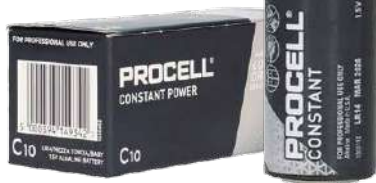

C



D



E

Pilas alcalinas industriales Procell

Pilas Duracell alcalinas.

Referencia	Artículo	Tipo	Caja	Embalaje
106000002	A	LR03 / AAA	10 unidades	10
106000003	B	LR6 / AA	10 unidades	10
106000028 ★	C	LR14 (C)	10 unidades	10
106000029 ★	D	LR20 (D)	10 unidades	10
106000004	E	6LR61 / 9V	10 unidades	10



Expositores comerciales

Expositores

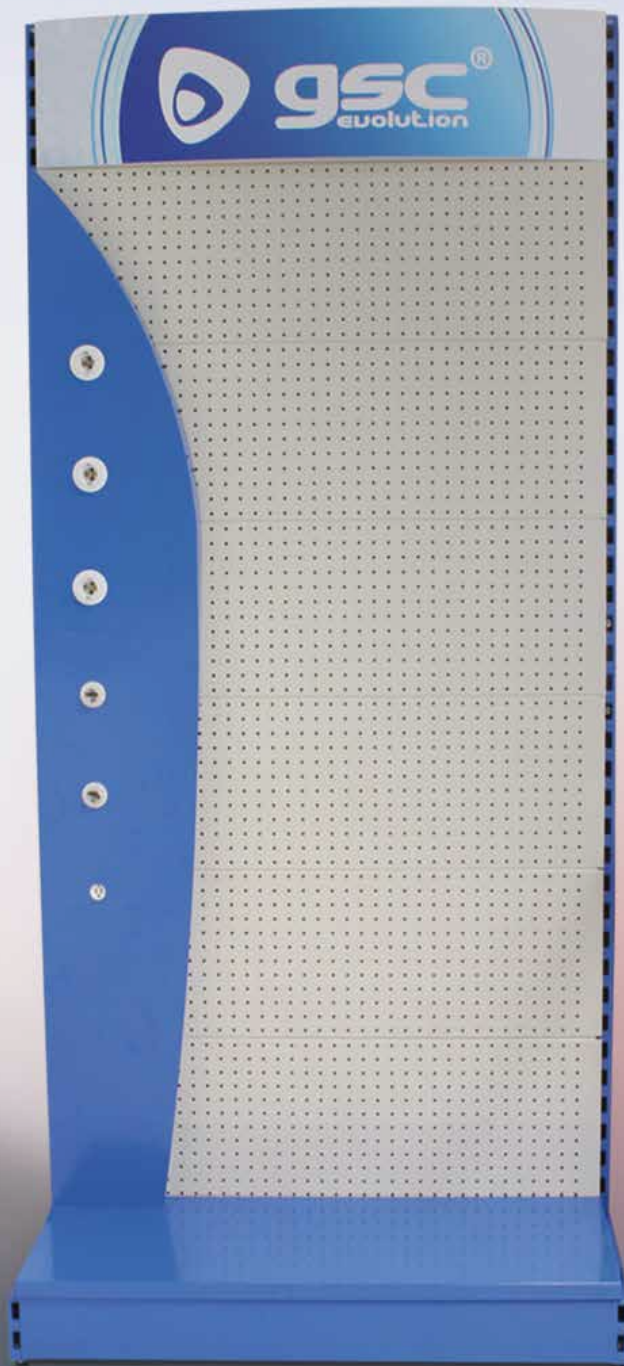



Expositor Lighter

400x235mm

Para probar bombillas. 230V.

Referencia	Casquillos	Embalaje
009704340	3xE27 / 1xE14 / 1xGU10	1



Expositor Socket

215x100x295mm

Expositor sobremesa para bases y/o embellecedores.

Referencia	Embalaje
009704356	1



*Sugerencia de presentación. Pilas no incluidas



Expositor Batteries

280x150x480mm

Expositor de sobremesa para pilas.

Referencia	Longitud ganchos	Embalaje
009704341	200mm	1



Expositor Essence

600x400x2100mm

Incluye: 24 ganchos dobles y 6 ganchos simples.

Referencia	Longitud ganchos	Embalaje
009704342	200mm	1

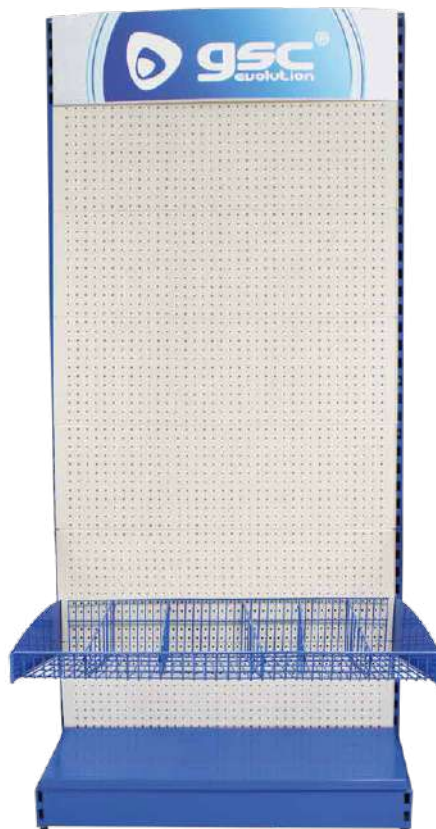

Expositor Genus



1000x450x2200mm

Customiza tu expositor Genus con las baldas, cestas y ganchos que necesites. Ideal para colgar tus productos GSC.

Referencia

Descripción

009704351

Expositor Genus

009704353

Gancho simple 200mm

009704354

Cesta

009704355

Balda





Área técnica

Información técnica



SIMBOLOGÍA / ICONOS



Protección para niños.
Indica que el producto tiene protección para niños.



Indica el tamaño del producto.
El tamaño siempre va representado por: ancho x profundo x alto.



Amperios.
Indica los amperios del producto.



On/Off.
Indica el número de veces que un producto puede encenderse y apagarse sin ningún tipo de fallo.



Índice de reproducción cromática. Es la capacidad que una fuente luminosa tiene para reproducir fielmente los colores de varios objetos en comparación con una fuente de luz natural.



Índice de estanqueidad.
Indica la IP que tiene el producto.



Ángulo de detección.
Indica el ángulo de detección de un producto con sensor.



Altura de instalación en techo.
Indica la altura de instalación a la que debe hacerse el producto.



Altura de instalación en pared.
Indica la altura de instalación a la que debe hacerse el producto.



Ángulo de apertura.
Indica la apertura de luz de la lámpara.



Horas de vida.
Indica las horas de vida del producto.



Voltaje.
Indica el voltaje del producto.



Hercios.
Indica los hercios del producto.



Antimosquitos.
Indica que el producto es adecuado para ahuyentar o matar insectos.



Indica la dirección de la luz.
Estos símbolos indican la dirección de la luz del producto.



Con sensor de presencia.
Indica que el producto tiene sensor de presencia.



Con sensor crepuscular.
Indica que el producto tiene sensor crepuscular, es decir que al llegar la noche se enciende.



Con sensor de presencia y crepuscular.
Indica que el producto tiene sensor de presencia y sensor crepuscular.



Compatible LED.
Indica que el producto es compatible con lámparas de LED.

CASQUILLOS



E14



E27



E40



MR16



GU10



MR11



G4



G9



GX53



2G11



R7s



G13



G24



S19



G10q



S14s



S14d

TEMPERATURA DE COLOR

Elegir la temperatura de color más adecuada para cada espacio es vital para crear diferentes estados de ánimo.

Por ello, a continuación os mostramos las 3 tonalidades de luz que puedes encontrar y los efectos que produce cada una.



2700K / 3000K

Si se desea transmitir un espacio cercano, relajado y exclusivo la temperatura óptima es 3000K, también denominada luz cálida.



3500K / 4200K

Si la idea es transmitir eficacia y estilo se puede utilizar un tono neutro con una temperatura de 4000K, también llamada luz día.



5000K / 6400K

Si la intención es crear un ambiente impersonal dinámico y activo, se recomienda escoger la temperatura de 6400K, también llamada luz fría.

Icono	Temperatura	Kelvin	Ambientes	Aplicaciones
	Luz cálida	2700K-3000K	Amistoso, íntimo, relajante, personal...	Restaurantes, hoteles, cafeterías...
	Luz día	3500K-4200K	Fresco, limpio, eficiente...	Recepciones, salones, boutiques...
	Luz fría	5000K-6400K	Dinámico, impersonal, activo...	Escuelas, hospitales, negocios abiertos 24h.

MARCADOS EMBALAJES



Marcado CE.

Indica por parte del fabricante de que el producto cumple con los requisitos legales y técnicos en materia de seguridad de los Estados miembros de la Unión Europea.



Aislamiento clase I.

Indica que estos aparatos tienen una conexión de protección con toma tierra por un conductor de color verde / amarillo.



Papelera tachada.

Este símbolo implica que no debes tirar el producto directamente a la basura. Se debe llevar a un lugar de reciclaje.



Aislamiento clase II.

Indica que el producto tiene doble aislamiento eléctrico y ha sido diseñado de tal forma que no requiere toma a tierra de seguridad eléctrica.



Símbolo Ecoembes.

Indica que el producto está acogido a la red de reciclaje de Ecoembes. El fabricante está pagando una tasa a la empresa Ecoembes para que se encargue de su reciclaje una vez el envase es depositado en el contenedor adecuado.



Aislamiento clase III.

Indica que un aparato con este símbolo está diseñado para ser alimentado con una fuente de alimentación SELV (Safety Extra-Low Voltage). La tensión de la fuente SELV es lo suficiente baja y si entra en contacto con ella con corra peligro de descarga eléctrica.



Símbolo regulable.

Este símbolo suele aparecer normalmente en productos de iluminación. Indica que el producto puede ser regulador en intensidad.



Uso interior.

Indica que el aparato está fabricado y diseñado para utilizar en lugares secos y alejados de humedades o condiciones meteorológicas como la lluvia.



Símbolo no regulable.

Este símbolo suele aparecer normalmente en productos de iluminación. Indica que el producto no puede ser regulador en intensidad.



Uso exterior.

Indica que el aparato está fabricado y diseñado para utilizar en lugares húmedos y/o en el exterior.



NUEVA NORMATIVA (EU) 2019/2015

A / Etiquetado para productos continente con drivers y fuentes de luz reemplazables.

Producto continente se define según la norma como:

"Producto que contiene una o varias fuentes luminosas o mecanismos de control independientes (driver). Son ejemplos de productos continentes las luminarias que pueden desmontarse para permitir la verificación independiente de las fuentes luminosas que contienen, los aparatos domésticos que contienen fuentes luminosas o los muebles (mostradores, espejos, vitrinas) con fuentes luminosas. Si un producto continente no puede desmontarse para la verificación de la fuente luminosa y del mecanismo de control independiente, todo el producto continente debe considerarse una fuente luminosa".



La nueva normativa para luminarias LED reemplazables nos invita a mostrar los **lúmenes y potencia del producto tanto con el difusor como sin el difusor**. Cuando mostramos los lúmenes debemos mostrar el tipo de máquina en el que se han medido dichos lúmenes. Es decir, es una esfera de 360° o en un cono de 90° o 120°.

Al producto con difusor también le llamamos luminaria y sin difusor lo denominamos fuente de luz.

Con difusor = Luminaria
Sin difusor = Fuente de luz

En la parte delantera **se mostrará la clase energética** a la que corresponde la fuente luminosa que lleva. Esos productos a diferencia de los anteriores no es necesario que lleve etiqueta energética.

Asimismo, debemos mostrar unos **iconos explicativos de si la fuente de luz y/o el driver es reemplazable o no** y por quién puede ser reemplazado. Además en el manual de instrucciones se especificará como sustituir o desmontar la placa LED o el driver.

B / Etiquetado para fuentes luminosas con driver y fuentes no desmontables.

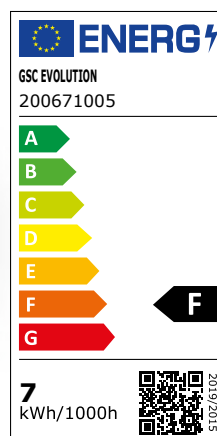

- Nombre de la marca del producto y referencia.
- **Nuevas clases energéticas**
Donde las letras más eficientes pasarán a ser los productos más novedosos del mercado con nuevas tecnologías.
- Eficiencia del producto
- Lugar donde podrás escanear el QR para **acceder a todos los detalles técnicos del producto**.
- Indica la potencia del producto.

000203397 / PAÍSES COMPATIBLES

ENTRADA (SUCKO)

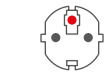

Europa (sucko)



Euro

SALIDA



Australia/China



UK



EE.UU



Suiza



Italia



Brasil

ENTRADA PRO (SUCKO)

Afghanistan	Cape Verde	Georgia	Latvia	Niger*	Somalia
Albania	Central African Republic	Germany	Lebanon*	Norway	Spain
Algeria	Chad	Gibraltar*	Liberia*	Oman*	Sudan
American Samoa*	Chile	Greece	Libya	Pakistan*	Suriname
Andorra	China*	Greenland	Liechtenstein	Paraguay	Sweden
Angola	Comoros	Guadeloupe	Lithuania	Peru*	Switzerland
Argentina*	Congo	Guinea	Luxembourg	Philippines (Rep. of the)*	Syrian Arab Republic
Armenia	Congo (Democratic Rep. of)	Guinea Bissau	Macau*	Poland	Tajikistan*
Aruba*	Cote d'Ivoire	Hungary	Macedonia	Portugal	Thailand*
Austria	Croatia	Iceland	Madagascar	Reunion	Timor-Leste*
Azerbaijan	Czech Republic	India*	Malaysia*	Romania	Togo
Bangladesh*	Egypt	Indonesia	Maldives*	Russia	Tunisia
Belarus	Ecuador	Iran	Mali	Rwanda	Turkey
Belgium	Egypt	Iraq*	Martinique	Saba*	Turkmenistan*
Benin	Denmark	Isle of Man*	Mauritania	Saint Martin	Ukraine
Bhutan*	Djibouti	Israel*	Mauritius*	Saint Vincent and the Grenadines*	United Arab Emirates*
Bolivia*	Equatorial Guinea	Italy	Moldova	San Marino	Uruguay*
Bonaire*	Eritrea	Jordan*	Monaco	Sao Tome and Principe	Uzbekistan*
Bosnia and Herzegovina	Ethiopia	Kazakhstan	Mongolia	Senegal	Vanuatu*
Brazil	Faroe Islands	Korea (Democratic People's Republic of)*	Montenegro	Serbia	Vietnam*
Bulgaria	Finland	Korea (Republic of)	Morocco	Singapore*	Zambia*
Burkina Faso	France	Kuwait*	Mozambique*	Sint Eustatius*	
Burundi	French Guiana	Kyrgyzstan	Myanmar*	Slovakia	
Cambodia*	Gabon	Lao People's Democratic Republic*	Nepal*	Slovenia	
Cameroon			Netherlands		
			New Caledonia		

SALIDA PRO

American Samoa	Colombia	Honduras	Malta	Rwanda	Tonga
Antigua and Barbuda	Cook Islands	Hong Kong*	Mariana Islands	Saba	Trinidad and Tobago
Argentina	Costa Rica	Iraq*	Marshall Island	Saint Kitts and Nevis*	Turkmenistan
Aruba	Cuba	Ireland	Mauritius	Saint Lucia	Turks and Caicos Islands
Australia	Curacao	Isle of Man	Mexico	Saint Vincent and the Grenadines*	Uganda
Bahamas	Cyprus	Italy	Montserrat	Samoa	United Arab Emirates*
Bahrain	Dominica*	Jamaica	Myanmar*	San Marino	United Kingdom
Bangladesh*	Dominican Republic	Jordan	Nauru	Saudi Arabia	United States of America
Barbados	Ecuador	Kenya	New Zealand	Seychelles	United States Virgin Islands
Belize	El Salvador	Kiribati	Nicaragua	Sierra Leone*	Uruguay
Bermuda	Eritrea	Kosrae	Niger*	Singapore*	Uzbekistan
Bhutan*	Ethiopia	Kuwait	Nigeria*	Sint Eustatius	Vanuatu
Bonaire	Falkland Islands (Malvinas)	Lao People's Democratic Republic of	Oman	Solomon Islands	Venezuela
Botswana*	Fiji	Lebanon*	Pakistan*	Sri Lanka*	Yap
Brazil	Gambia	Liberia*	Palau	Switzerland	Yemen*
British Virgin Islands	Ghana*	Liechtenstein	Panama	Syrian Arab Republic	Zambia*
Brunei Darussalam	Gibraltar	Macau*	Papua New Guinea	Taiwan	Zimbabwe*
Cambodia*	Grenada	Madagascar*	Philippines (Rep. of the)	Tajikistan	
Canada	Guam	Malawi	Pohnpei	Tanzania*	
Cayman Islands	Guatemala	Malaysia*	Puerto Rico	Thailand	
Chile	Guyana*	Maldíves*	Qatar*	Timor-Leste	
China*	Haiti				
Chuuk					

* Varios tipos de enchufe en ese país.



ESQUEMA CONEXIONADO PANTALLAS ESTANCAS LED

PARA REFERENCIAS 000702283 / 000702285 / 000702288

MODO CONEXIÓN ORIGINAL CON REACTANCIA MAGNÉTICA

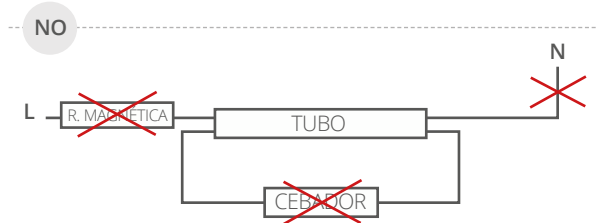

MODO CONEXIÓN ORIGINAL CON REACTANCIA ELECTRÓNICA

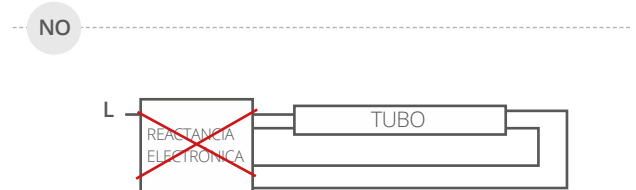

NUEVO MÉTODO DE CONEXIÓN

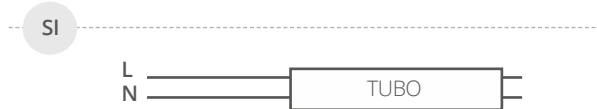

NUEVO MÉTODO DE CONEXIÓN

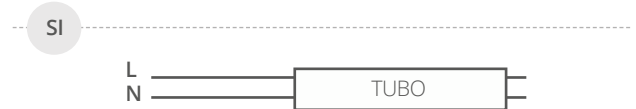

CONEXIONADO TUBOS CIRCULARES LED

PARA REFERENCIAS 200800001 / 200800002 / 200800003

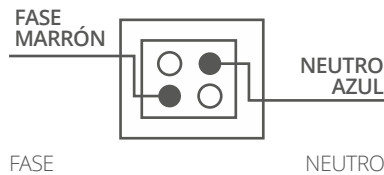

CONEXIONADO LINESTRAS LED

PARA REFERENCIAS 200615004 / 200615005 / 200615006 / 200615002 / 200615003

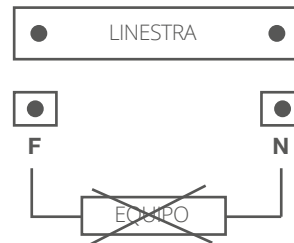

Inhabilitar el transformador y unir casquillos.

CONEXIONADO PL DE LED

PARA REFERENCIAS 200630014 / 200630015 / 200630016 / 200630017

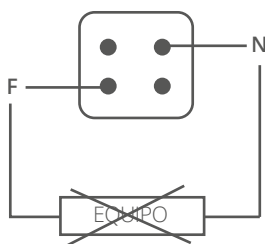

Funciona directo a 230V. Se debe retirar el transformador eléctrico o magnético.

CONEXIONADO PL DE LED

PARA REFERENCIAS 200630003 / 200630004 / 200630005 / 200630006

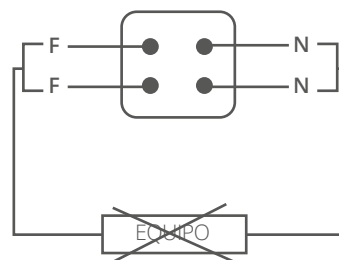

Funciona directo a 230V. Se debe retirar el transformador eléctrico o magnético.

ANTES DE INSTALAR UNA TIRA LED MONOCROMO O RGB

1. **No conectar la tira LED cuando esté enrollada** dentro del carrete.
2. **Calcular los metros** que se necesitan.
3. La conexión máxima en serie **no debe superar nunca los 10M.**
4. Multiplicar la **potencia (W)** de la tira por los metros de tira que se necesitan.
5. Una vez obtenidos el W necesario seleccionar la fuente adecuada. Hay que dejar un margen de seguridad del 20% más para el buen funcionamiento del transformador.
6. **Para conectar más de una tira por fuente de alimentación** hay que tener en cuenta los canales de la fuente y realizar un cálculo con la siguiente fórmula.

$$\frac{W \text{ fuentes}}{N^{\circ} \text{ canales}} = W \text{ máx. por canal}$$

* Recordar dejar el porcentaje de seguridad.

CONEXIONADO TIRAS LED MONOCROMO Y RGB

1. **Medir** el espacio donde se va a instalar la tira LED.
 2. **Cortar** el tramo necesario según el espacio en el que se va a instalar.
- Nota:** **cortar** la tira por las líneas de **puntos marcados** según modelo.
3. Limpiar la superficie donde se va a pegar la tira. Retirar el papel protector adhesivo de la parte posterior (ir con cuidado ya que es fácil despegar la cinta de doble cara incorrectamente y la tira no pegará. En caso de retirar un poco de cinta y no pega, volver a empezar el proceso para despegarla correctamente) y pegar en el espacio seleccionado.
 4. Para mejorar la **dispersión del calor** se recomienda colocar la tira LED en un perfil de aluminio de 1-2mm de grosor pegada con la cinta 3M que tiene incorporada.
 5. **Conexión**, si la tira LED dispone de un jack conectar la fuente de alimentación directamente al jack y conectar la fuente a la red eléctrica.

INSTALACIÓN TIRAS LED MONOCROMO

A. Con jack

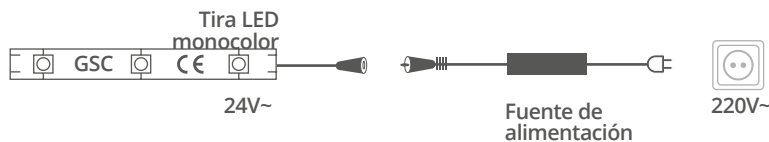

B. Sin jack

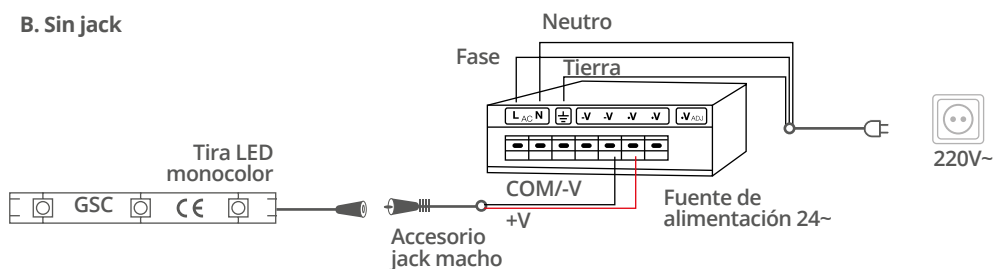

INSTALACIÓN TIRAS LED RGB

A. Con jack

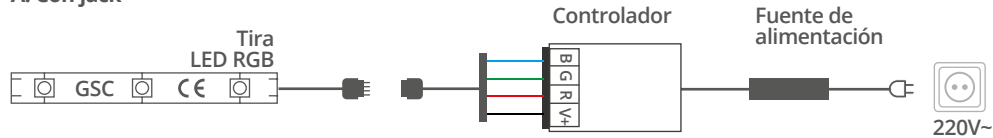

B. Sin jack

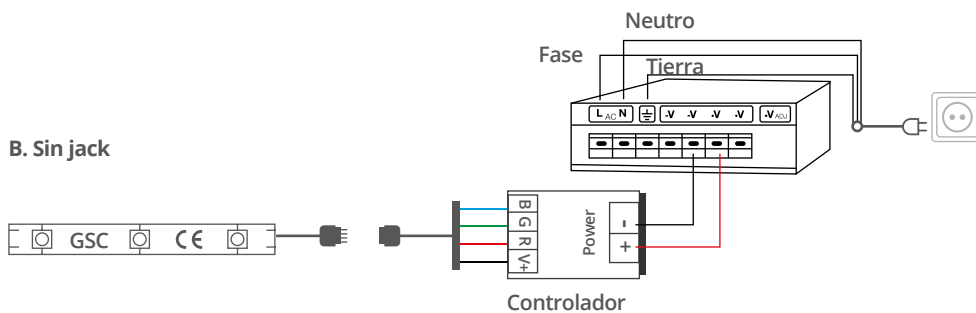

ANTES DE INSTALAR UNA TIRA LED 230V

1. **No conectar la tira LED** cuando esté **enrollada** dentro del carrete.
2. **Calcular** los metros que se necesitan.
3. La **conexión máxima** en serie no debe superar nunca los **30M**. Para evitar pérdidas de intensidad al final de la tira la instalación ideal sería de 30M.

CONEXIONADO TIRAS LED 230V

1. **Medir** el espacio donde se va a instalar la tira LED.
2. **Cortar** el tramo necesario según el espacio donde se va a instalar.

Nota: **cortar** la tira por las líneas de **puntos marcados** según modelo.

3. Limpiar la superficie donde se va a pegar la tira. Retirar el papel protector adhesivo de la parte posterior (ir con cuidado ya que es fácil despegar la cinta de doble cara incorrectamente y la tira no pegará. En caso de retirar un poco de cinta y no pega, volver a empezar el proceso para despegarla correctamente) y pegar en el espacio seleccionado.

4. Para mejorar la **dispersión del calor** se recomienda colocar la tira LED en un **perfil de aluminio** de 1-2mm de grosor pegada con la cinta 3M que tiene incorporada.

5. **Conexión con cable.** Una vez tenemos ya cortada la longitud necesaria de tira LED a 230V, conectar directamente a la red eléctrica mediante una clavija. Puedes adquirir alguna de nuestras clavijas Ref. 000200483-84 / 000200059 / 00020019 / 102015002 entre otras). **Nota:** recordar sellar la tira con la tapa final. Una vez realizada la conexión, el siguiente paso es conectar la tira a la red eléctrica.

Conexión sin cable. El accesorio que se necesita es el Kit de corte para tira LED (Ref.: 204005006) incluye pegamento resistente al agua, tapa final (1Ud), tapa final con agujeros para el cable (1Ud), clips de montaje en superficie (1Ud) y 20cm de cable 2x0.75mm². Para conectar la tira LED, el **cable eléctrico** debe de ser soldado en ella. La **tapa final** y la **tapa con 2 agujeros** deben ser sellados, utilizando el pegamento incluido en el Kit.

Una vez realizada la conexión el siguiente paso es **conectar la tira a la red eléctrica. El kit no incluye clavija.**

INSTALACIÓN TIRAS LED 230V

A. Con cable

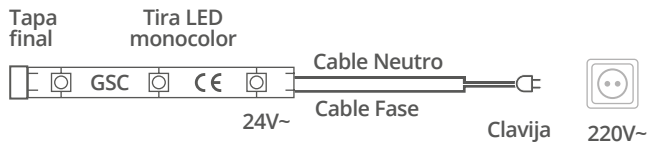

B. Sin cable

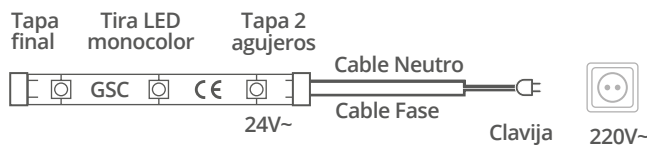

ANTES DE INSTALAR UNA FUENTE DE ALIMENTACIÓN

Antes de comenzar cualquier trabajo de instalación o mantenimiento, desconectar la fuente de alimentación. Asegurarse de que no se pueda volver a conectar inadvertidamente.

- Antes de conectar la fuente de alimentación hay que verificar la cantidad de energía que se necesita, para no sobrecargar y dañar el dispositivo.

- Mantener una ventilación adecuada alrededor de la unidad y no apilar ningún objeto sobre ella. Además, se debe mantener un espacio libre de 10 a 15 cm cuando el dispositivo adyacente es una fuente de calor.

- Las orientaciones de montaje distintas de la orientación estándar o el funcionamiento a temperatura ambiente elevada pueden aumentar la temperatura del componente interno y requerirán una reducción de la corriente de salida.

CONEXIONADO FUENTES DE ALIMENTACIÓN

Elegir la fuente de alimentación que mejor se adapte teniendo en cuenta el voltaje y los metros de tira LED.

Una vez tenemos la fuente de alimentación adecuada sólo queda realizar las conexiones según los esquemas que se muestran a continuación.

INSTALACIÓN FUENTE DE ALIMENTACIÓN

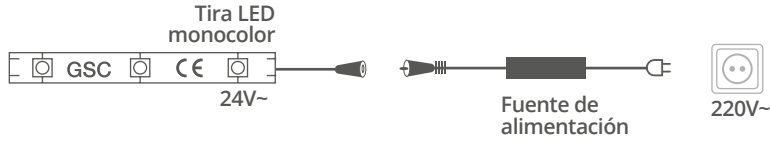

INSTALACIÓN FUENTE DE ALIMENTACIÓN CONMUTADA

A. TIRA LED MONOCOLOR

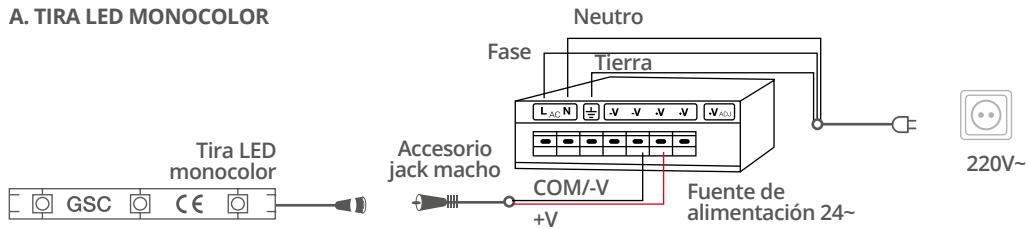

B. TIRA LED RGB

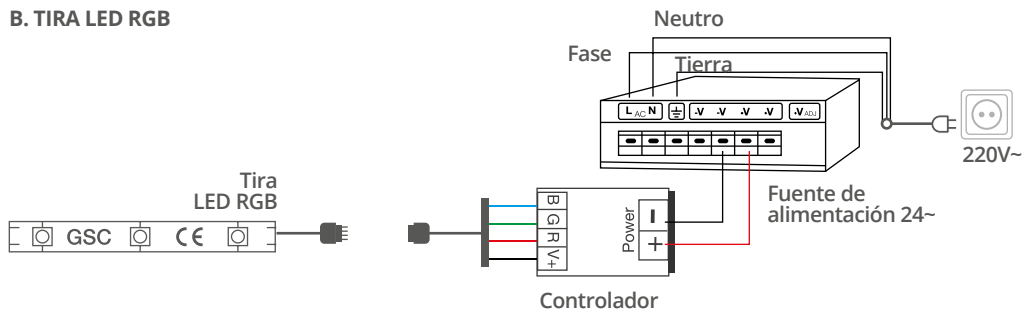

INSTALACIÓN FUNTE DE ALIMENTACIÓN ESTANCA

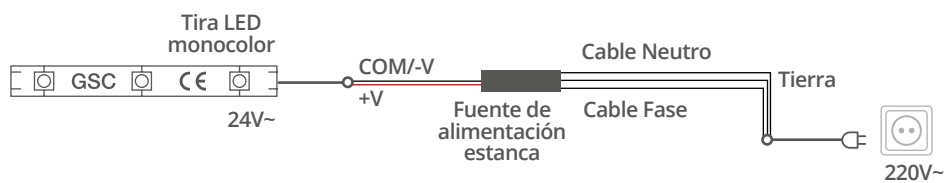

201010006 / ESQUEMA DETECCIÓN

000203391 / ESQUEMA CONEXIONADO

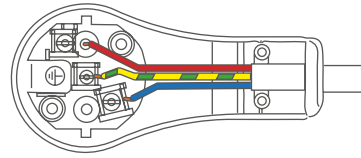
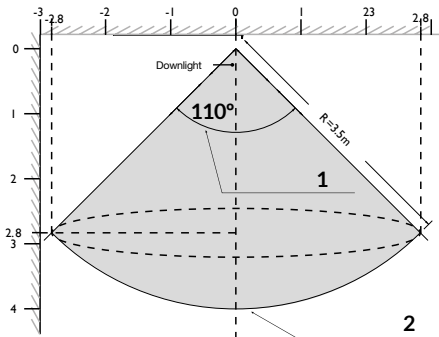

Gama de inducción de infrarrojos

1. Ángulo de detección: 110°
2. Distancia de detección: 3.5M

002703011 / ESQUEMA CONEXIONADO

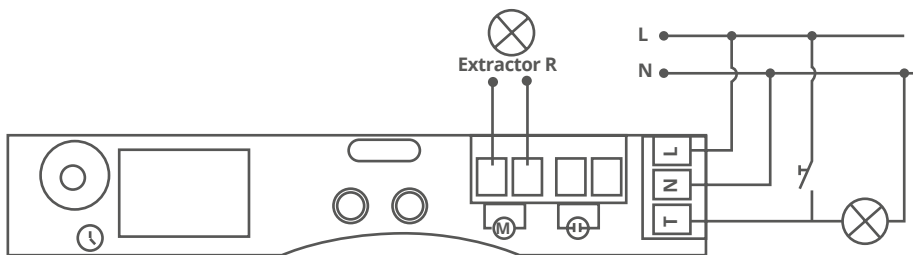

105515002 / POTENCIA PUERTOS

UN PUERTO CARGANDO

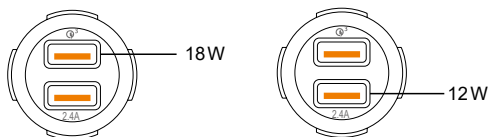

DOS PUERTOS CARGANDO

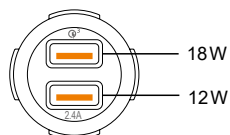

105515003 / POTENCIA PUERTOS

UN PUERTO CARGANDO

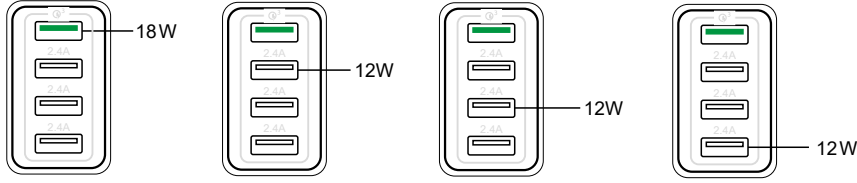

DOS PUERTOS CARGANDO

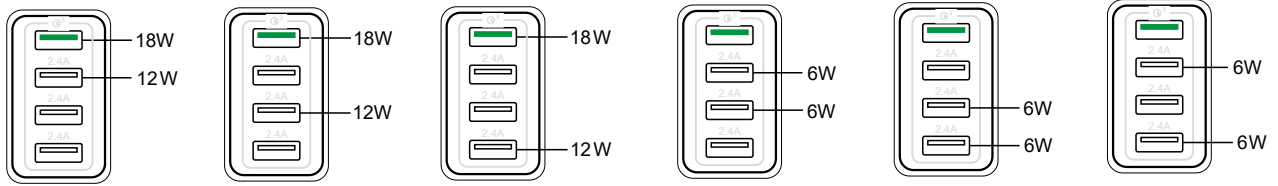

TRES PUERTOS CARGANDO

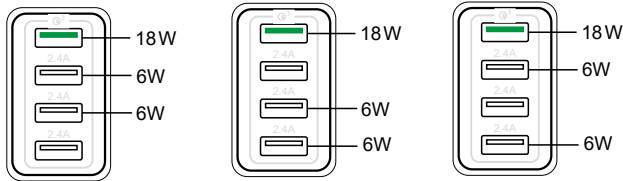

CUATRO PUERTOS CARGANDO

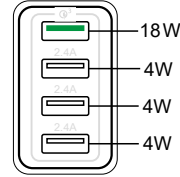

105515006 / POTENCIA PUERTOS

UN PUERTO CARGANDO

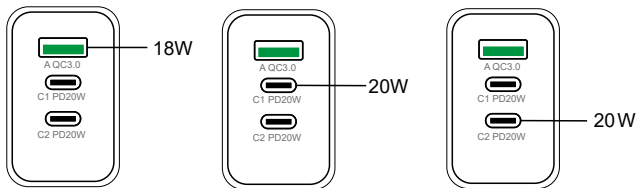

DOS PUERTOS CARGANDO

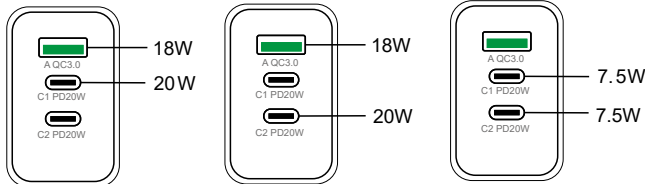

TRES PUERTOS CARGANDO

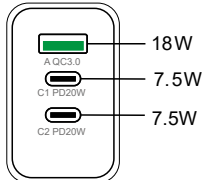

105515001 / POTENCIA PUERTOS

UN PUERTO CARGANDO

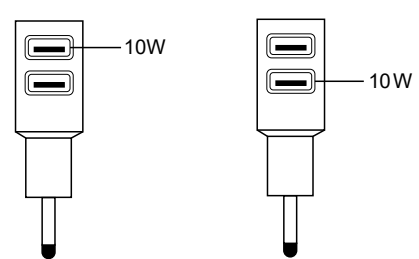

DOS PUERTOS CARGANDO

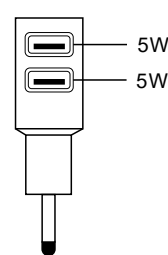

204605013 / ESQUEMA

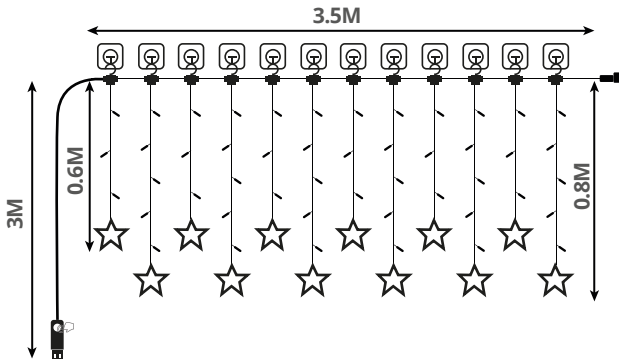

204605012 / ESQUEMA

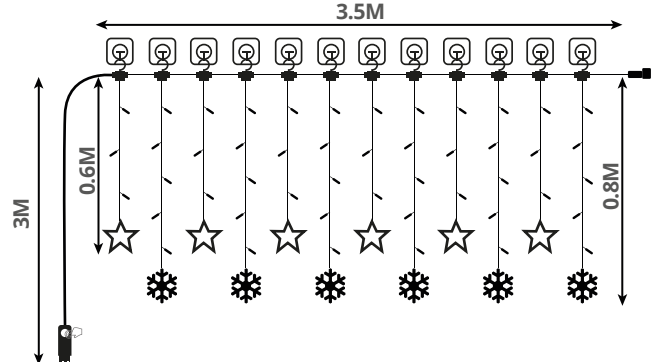

204605026

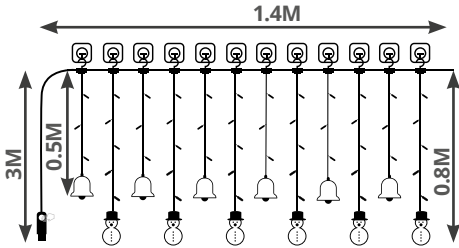

204605024

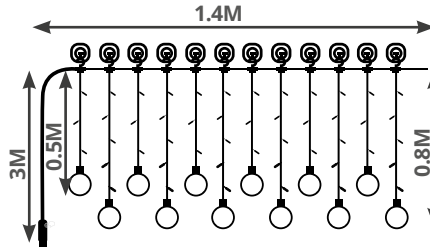

204605025

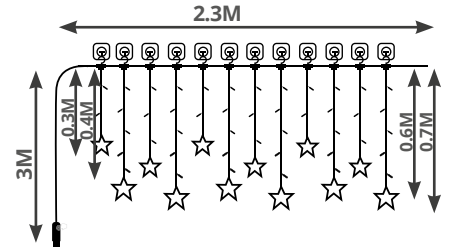

ESQUEMA CORTINAS LED LUMINOSAS

204605001-02

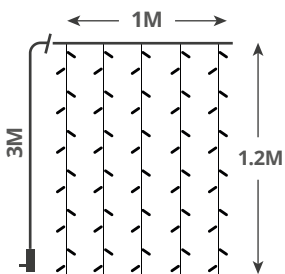

204605003-04

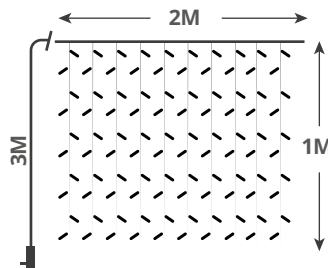

204605005-06-07

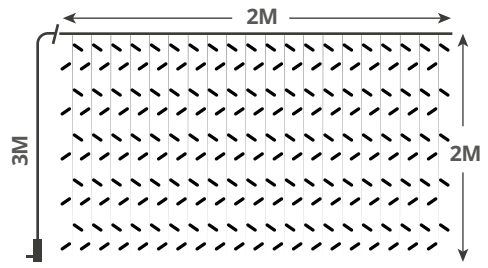

204605008-09

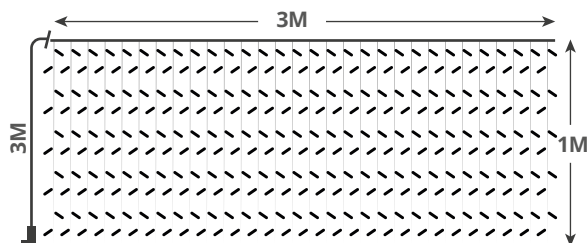

204605010-11

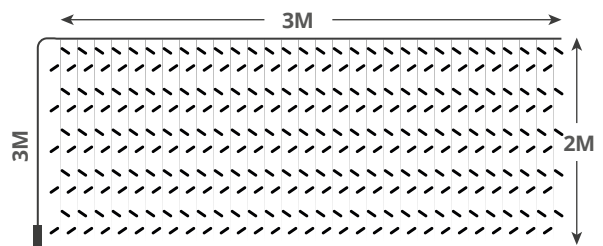

POLÍTICA DE GARANTÍA



Todos nuestros productos GSC están sometidos a controles y evaluaciones que garantizan la calidad de todos los productos que ponemos a la disposición de nuestros consumidores, según la **Directiva 73/23/EEC**.

Asimismo, todos y cada uno de nuestros productos tienen **marcado el CE**, símbolo que garantiza que los productos GSC cumplen los requisitos esenciales de seguridad recogidos en las directivas que les puedan concernir.

Además, **GSC ofrece 3 años de garantía** en todos sus productos siempre y cuando se cumplan las normas y los requisitos de instalación.



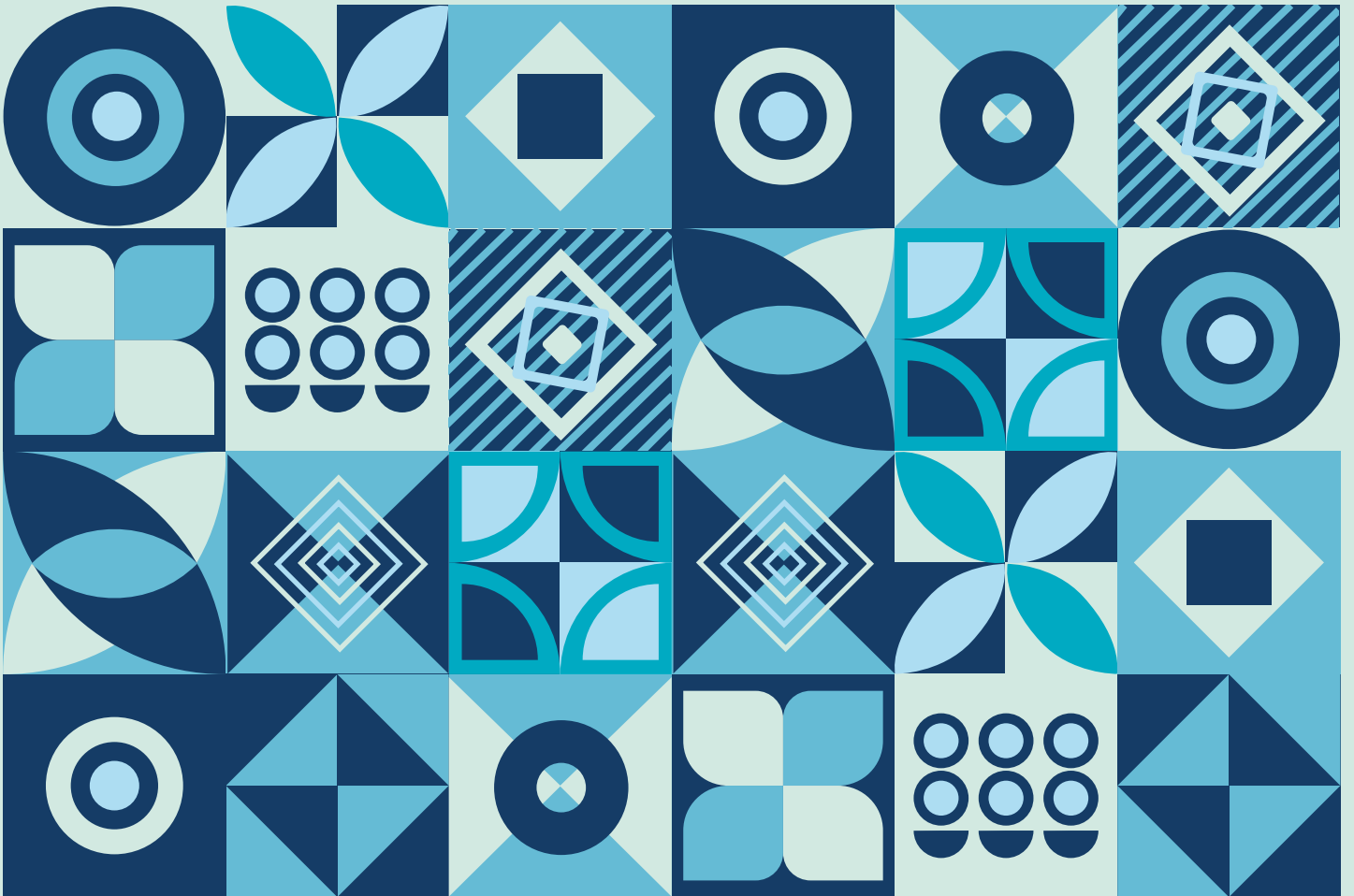

Dirección Pol. Ind. Molí D'En Llop.
C/ Corts Valencianes 10. 12549 Betxí (CS) SPAIN.



Email
info@garsaco.com



Teléfono
+34 964 623 022

Join!
us!



www.garsaco.com



gsc[®]
evolution



Dirección Pol. Ind. Molí D'En Llop.
C/ Corts Valencianes 10. 12549 Betxí (CS) SPAIN.



Email
info@garsaco.com



Teléfono
+34 964 623 022

www.garsaco.com

